

Hinterlegungen
Dépôts
Deposit

Cl. 2-06 128 966 17.07.2002
 1 Design — Handschuh
 Fortis Uhren AG, Lindenstrasse 45, 2540 Grenchen. Rechts-
 nachfolgerin des Designers Peter Peter, Sarstedt.



Deko Handschuh 02

Cl. 2-06 128 967 06.08.2002
 2 designs – gant de protection
 Mastrad Société Anonyme, 12 rue du 4 Septembre, Paris (FR)
 Ayant cause du designer Lucas Bignon, Cachan
 Mand.: Bovard SA, Berne
 Prior.: USA 19.02.2002

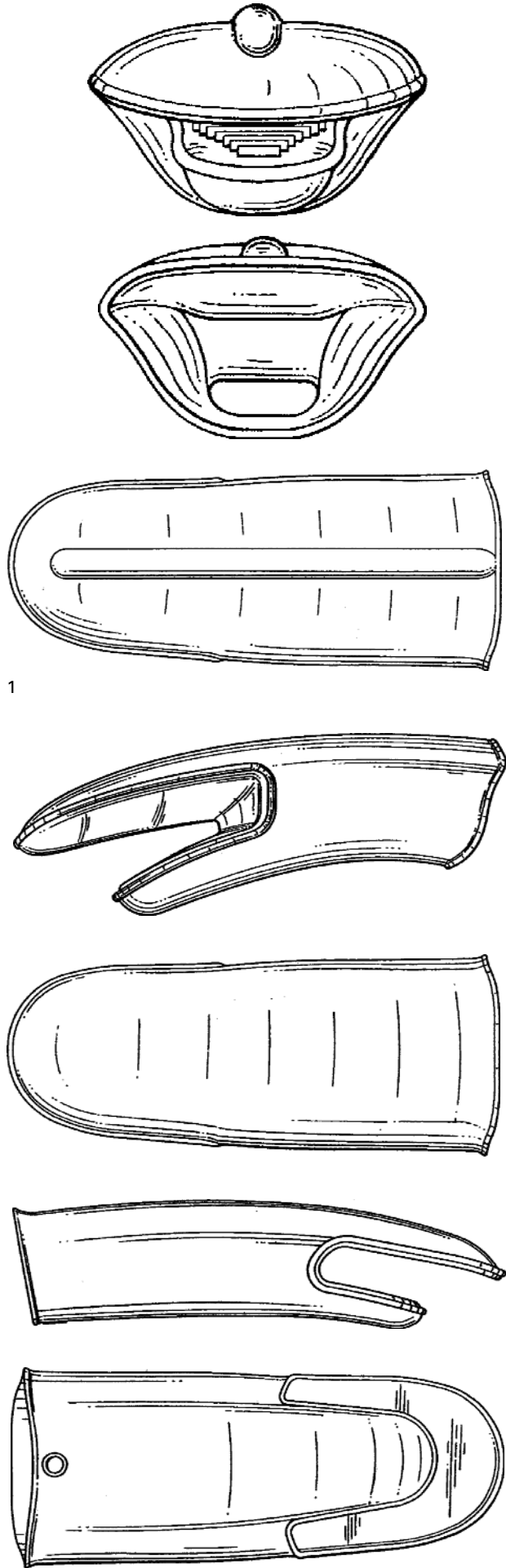
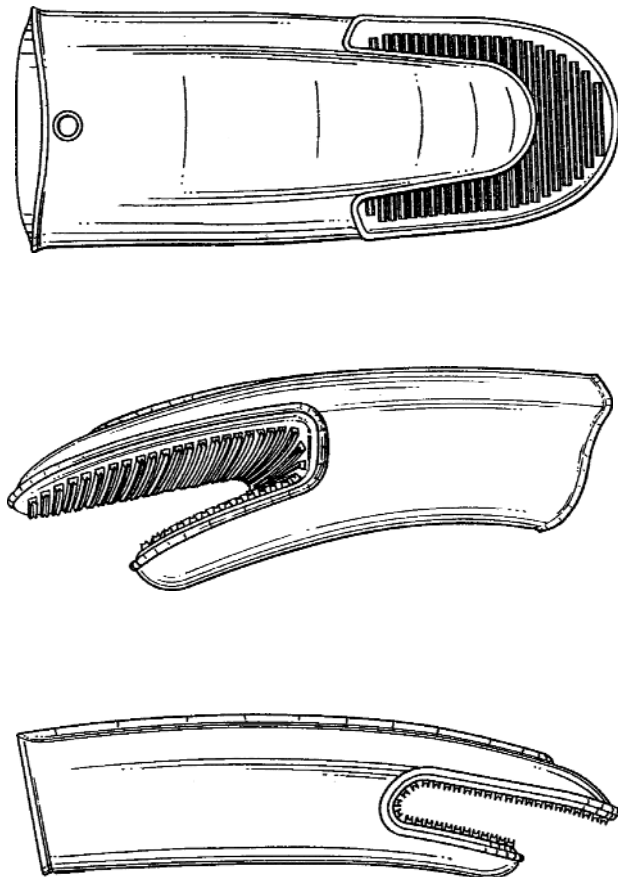

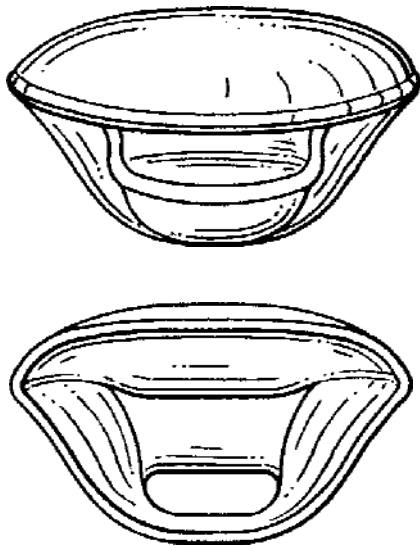

2

Cl. 3-01 128 968 23.07.2002
 1 Design – Tasche
 Oskar Debrunner AG, Dunantstrasse 12, Postfach,
 8570 Weinfelden. Rechtsnachfolgerin des Designers
 Thomas Debrunner, Weinfelden



Swiss 01

Cl. 6-04 128 969 02.07.2002
 1 Design – CD-Halterung
 Martin Birrer, Mattenenge 4, 3011 Bern



CD-Box 02

Cl. 6-04 128 970 31.07.2002
 1 Design – Regal
 Thomas Giger, Heidechile 15, 8907 Wettswil

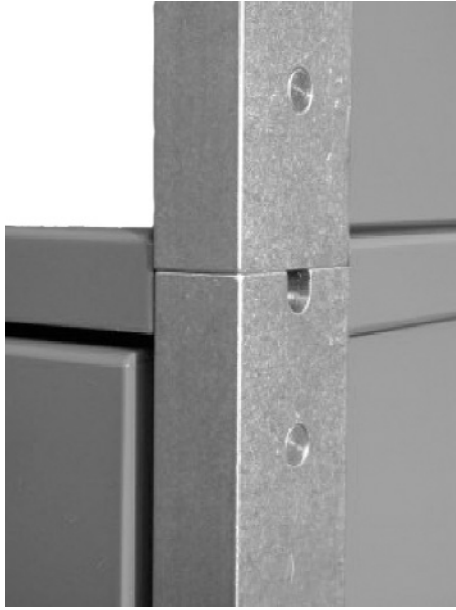

Archibald

Cl. 6-11 128 971 06.08.2002
 1 Design – Teppich
 Isabel Bürgin, Klybeckstrasse 14, 4056 Basel

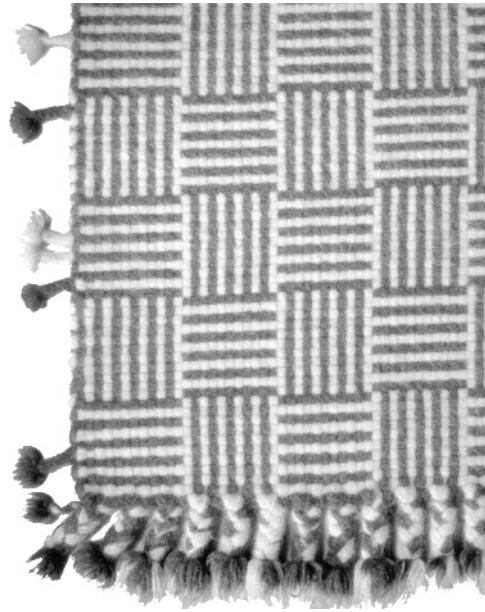

2

Cl. 7-01 128 972 05.08.2002
 1 Design – Deckel
 Dart Industries Inc., 14901 S. Orange Blossom Trail,
 Orlando/FL (US). Rechtsnachfolgerin der Designer Vincent Jalet,
 Brussels und Victor J. J. Cautereels, Ranst.
 Vertr.: A. Braun, Braun, Héritier, Eschmann AG, Basel
 Prior.: USA 07.02.2002

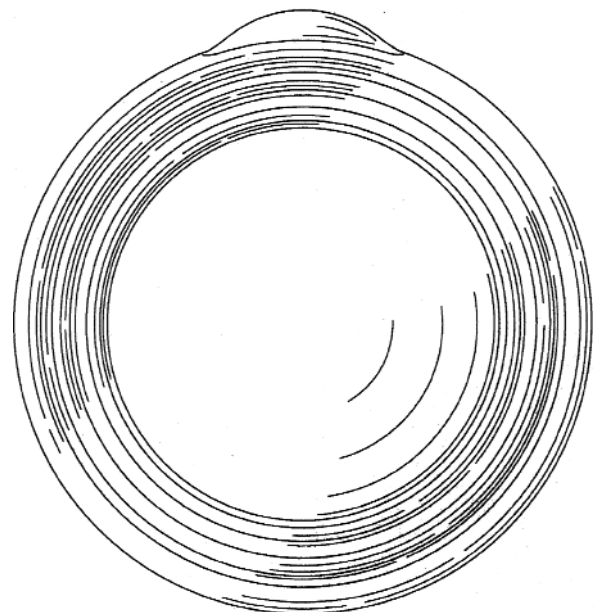
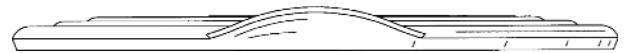
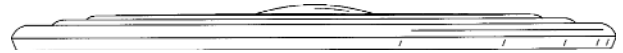

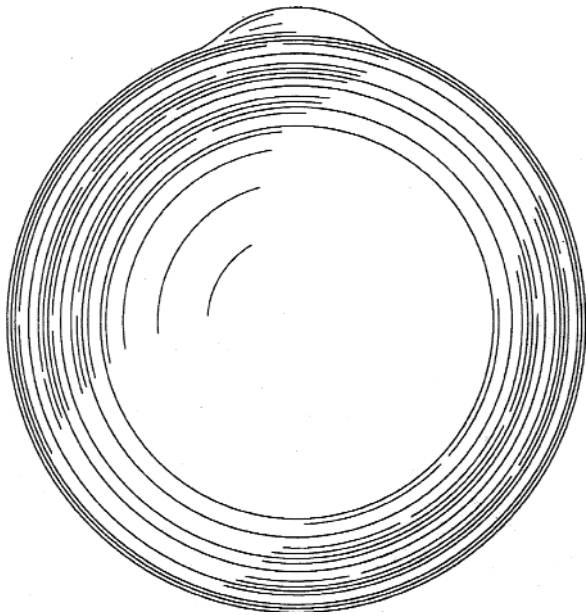

D.25/2002

Cl. 7-01 128 973 05.08.2002
 2 Designs – Schüssel
 Dart Industries Inc., 14901 S. Orange Blossom Trail,
 Orlando/FL (US). Rechtsnachfolgerin der Designer Vincent Jalet,
 Brussels; Robert H. C. M. Daenen, Aalst und
 Victor J. J. Cautereels, Ranst.
 Vertr.: A. Braun, Braun, Héritier, Eschmann AG, Basel
 Prior.: USA 07.02.2002

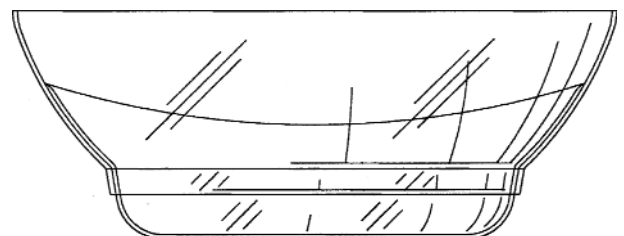
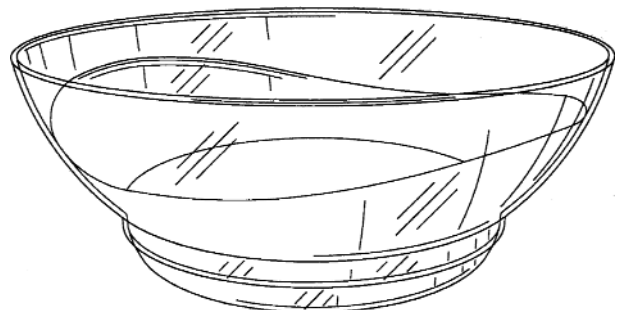
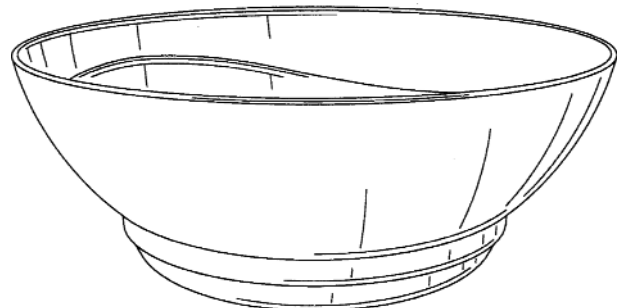
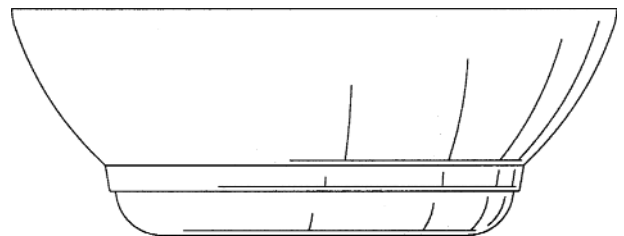
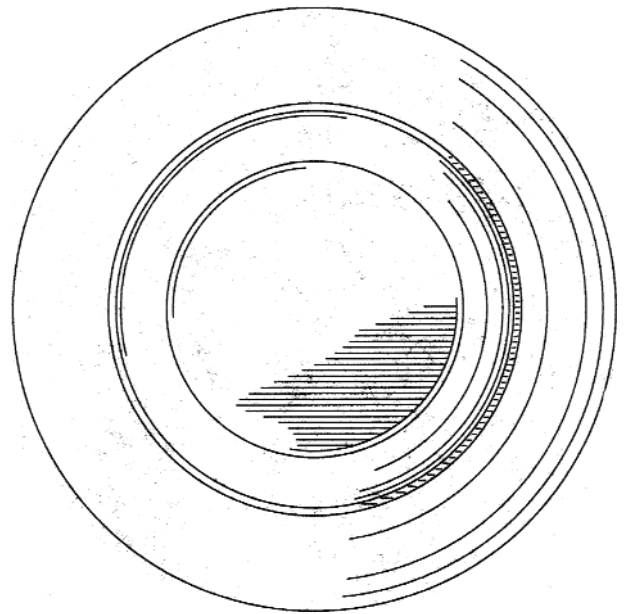
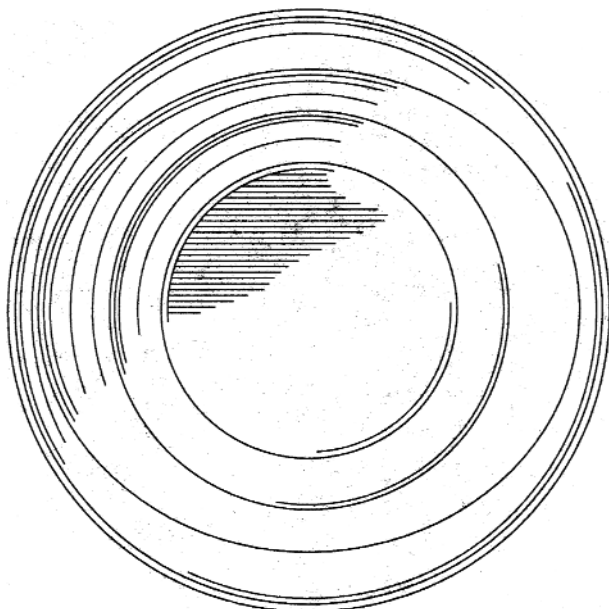
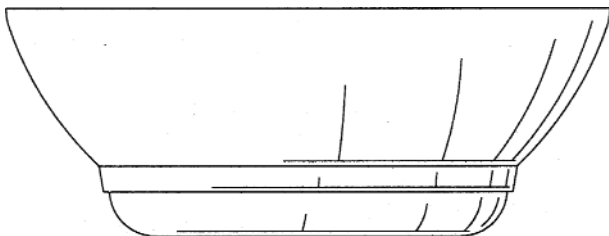

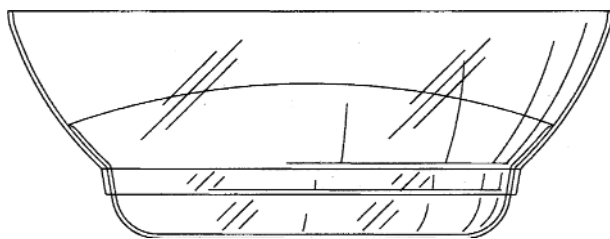

Cl. 7-01 128 974 05.08.2002
2 Designs – Schüssel
Dart Industries Inc., 14901 S. Orange Blossom Trail,
Orlando/FL (US). Rechtsnachfolgerin der Designer
Vincent Jalet, Brussels; Robert H. C. M. Daenen, Aalst und
Victor J. J. Cautereels, Ranst.
Vertr.: A. Braun, Braun, Héritier, Eschmann AG, Basel
Prior.: USA 07.02.2002

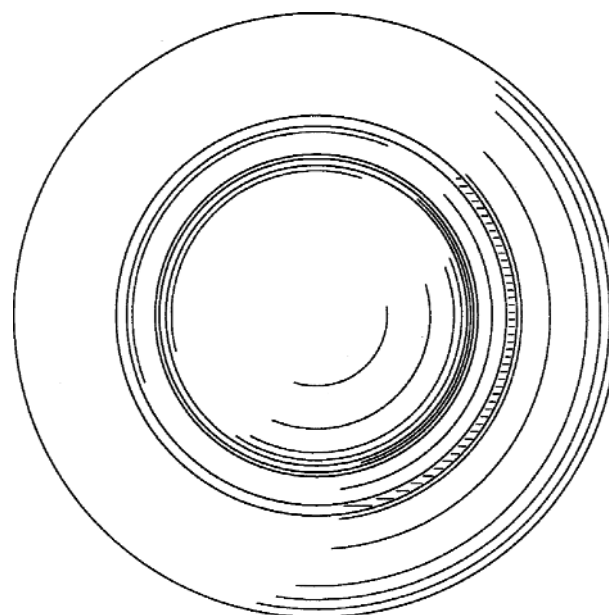
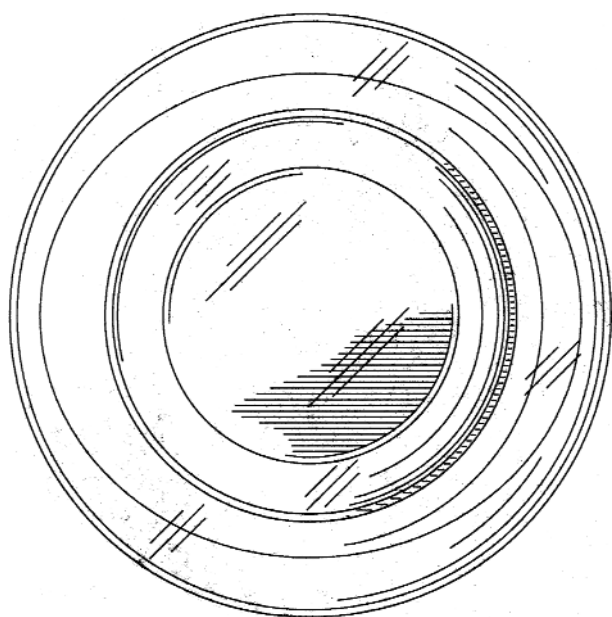
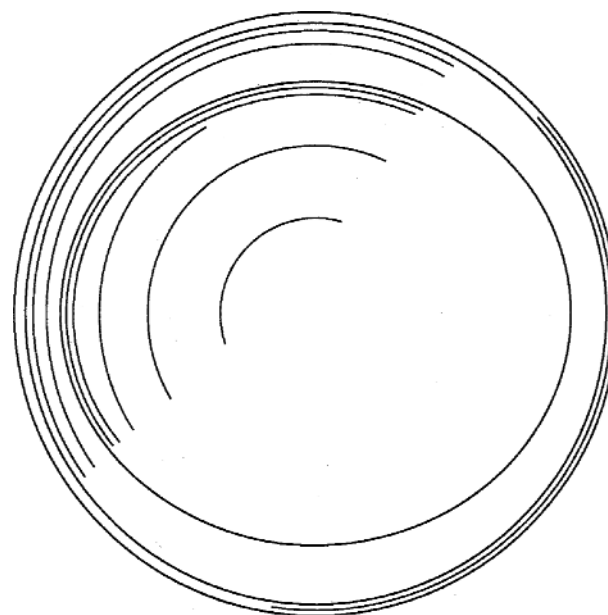
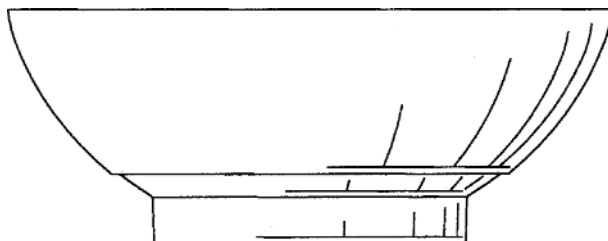
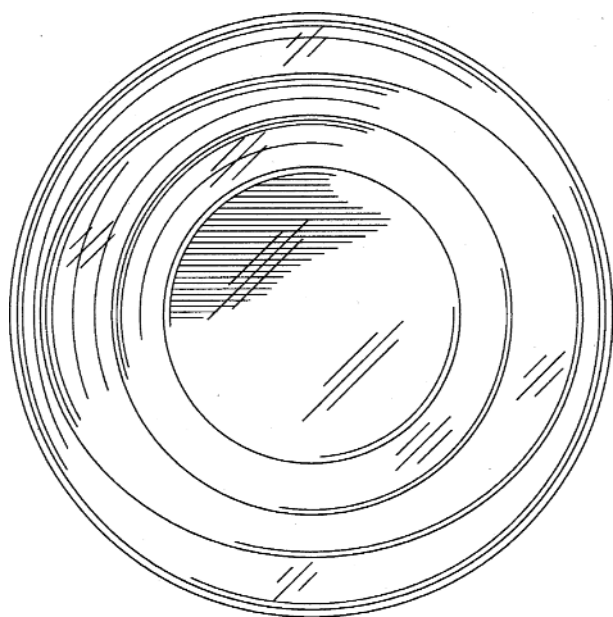

D.26/2002

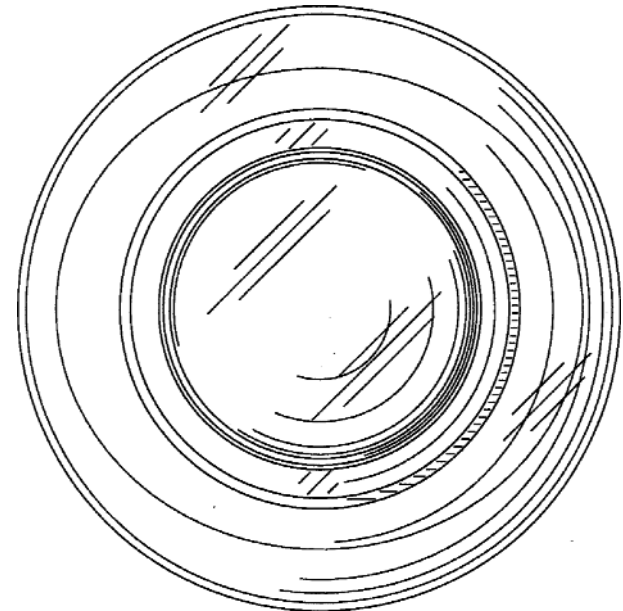
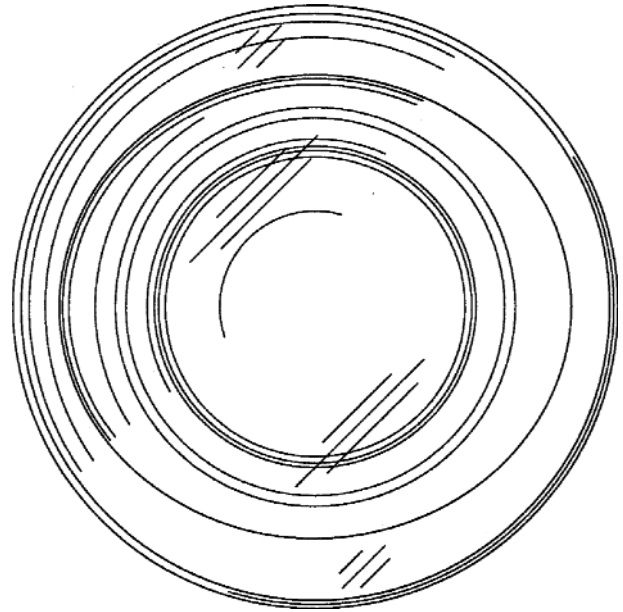
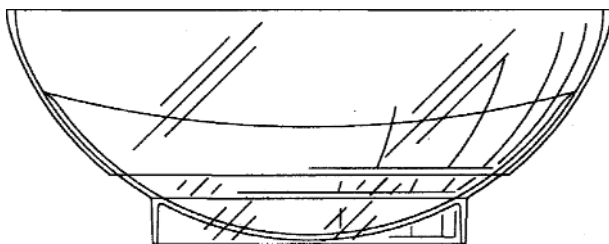
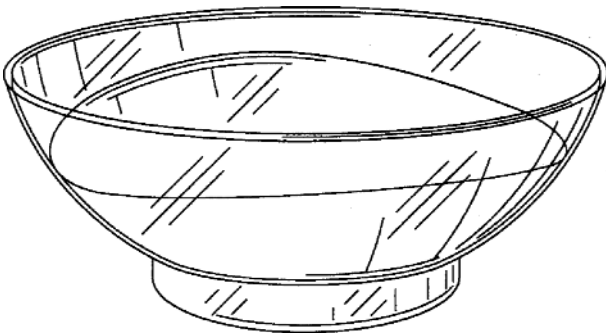
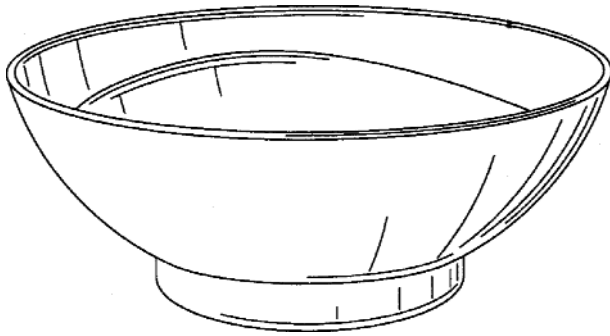
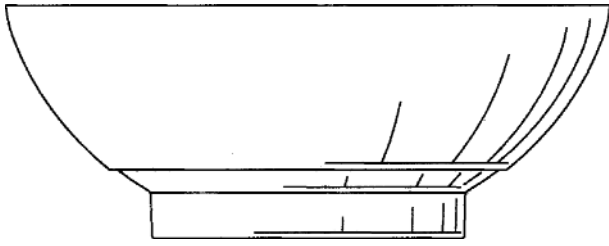

D.27/2002

Cl. 7-01 128 975 05.08.2002

2 Designs – Schüssel

Dart Industries Inc., 14901 S. Orange Blossom Trail,

Orlando/FL (US). Rechtsnachfolgerin der Designer

Vincent Jalet, Brussels; Robert H. C. M. Daenen, Aalst und

Victor J. J. Cautereels, Ranst.

Vertr.: A. Braun, Braun, Héritier, Eschmann AG, Basel

Prior.: USA 07.02.2002

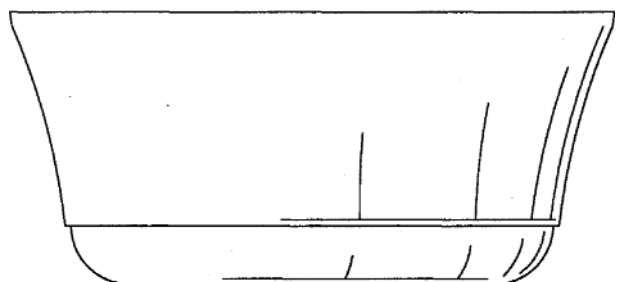

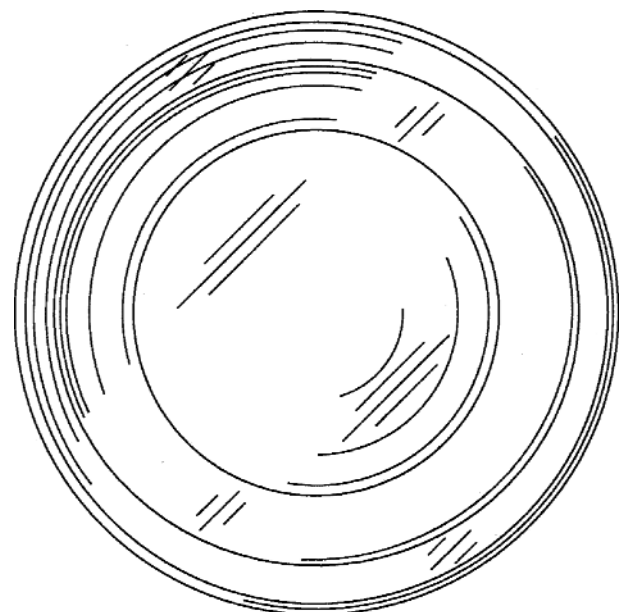
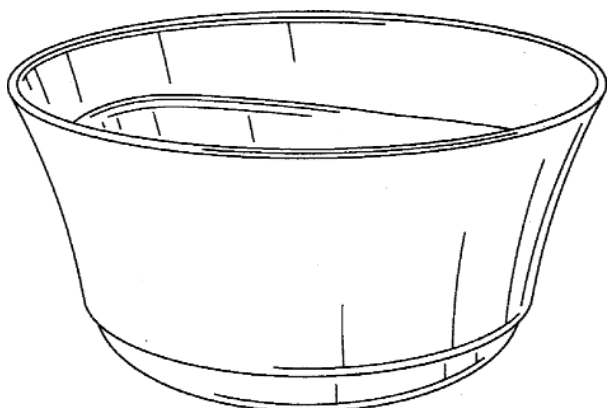
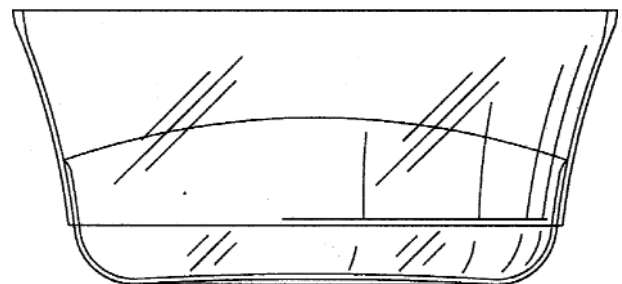
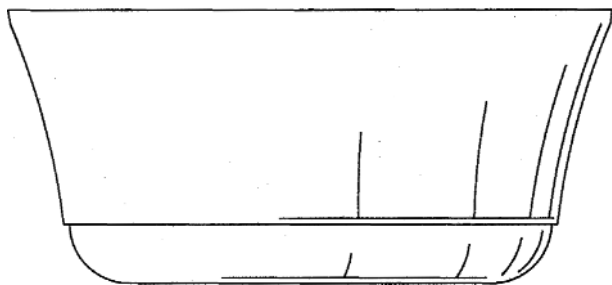
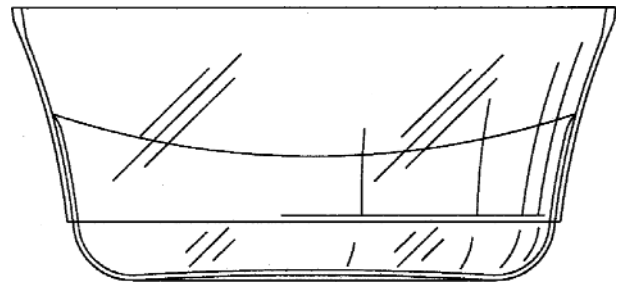
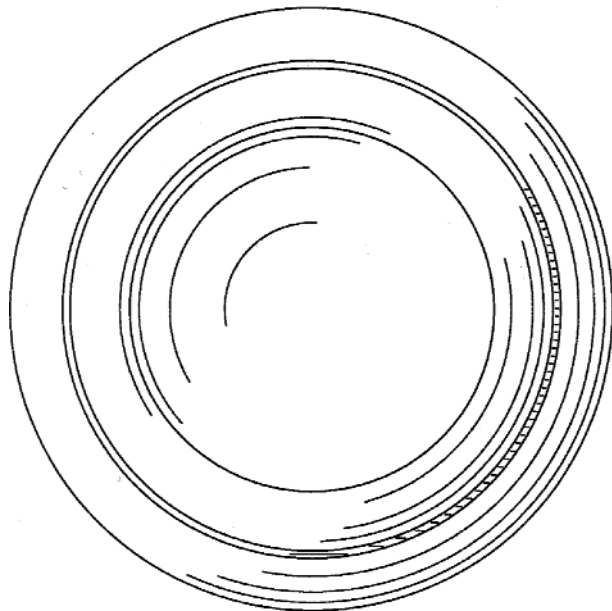
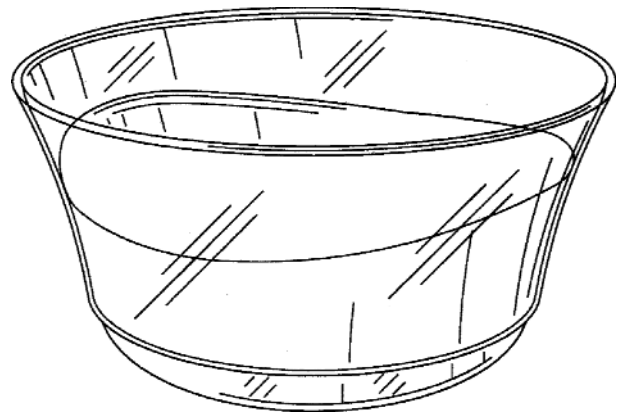
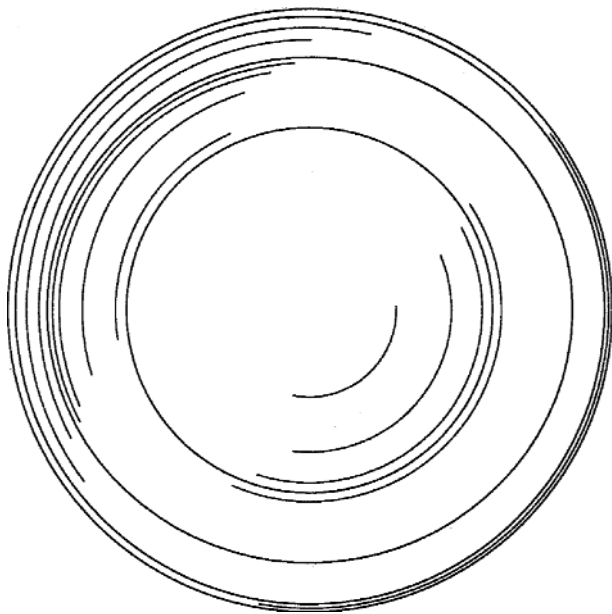

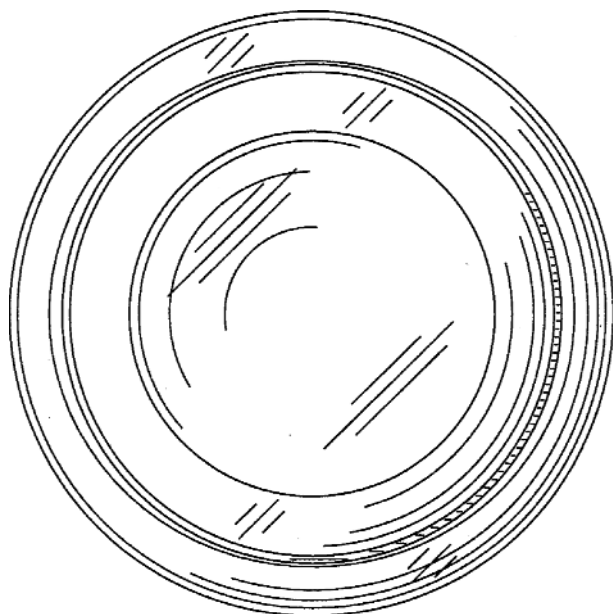

D.28/2002

Cl. 7-04 **128 976** 05.08.2002
 1 Design – Knoblauchpresse
 Dart Industries Inc., 14901 S. Orange Blossom Trail,
 Orlando/FL (US). Rechtsnachfolgerin der Designer Stig
 Lillelund, Gentofte und Jakob Heiberg, Charlottenlund.
 Vertr.: A. Braun, Braun, Héritier, Eschmann AG, Basel
 Prior.: USA 07.02.2002

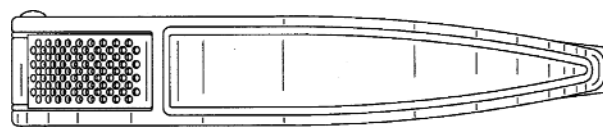
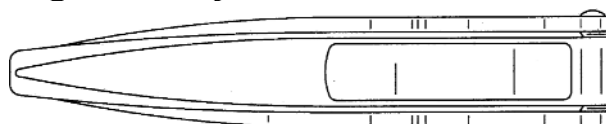
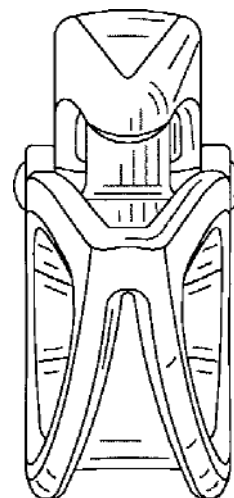
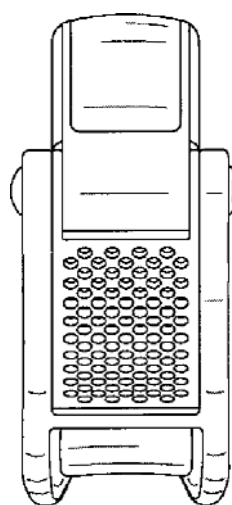
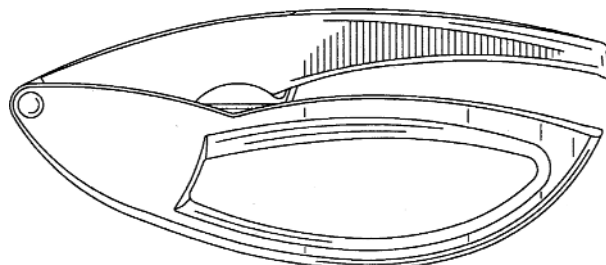
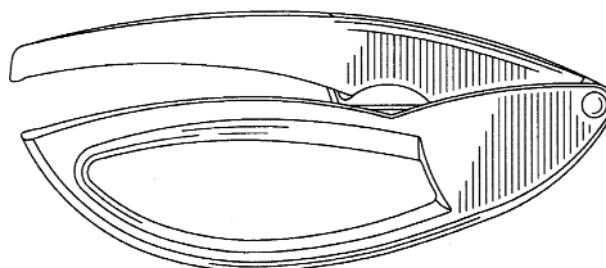
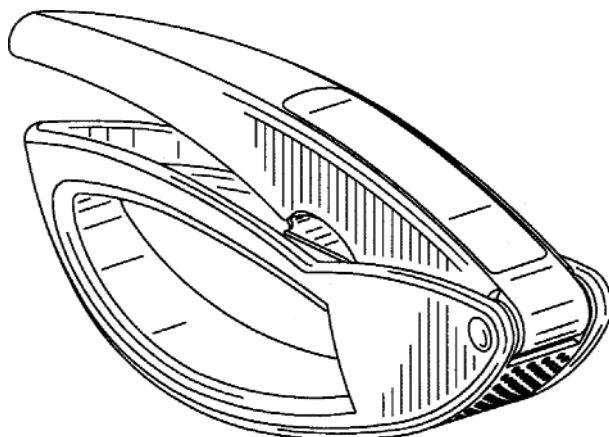
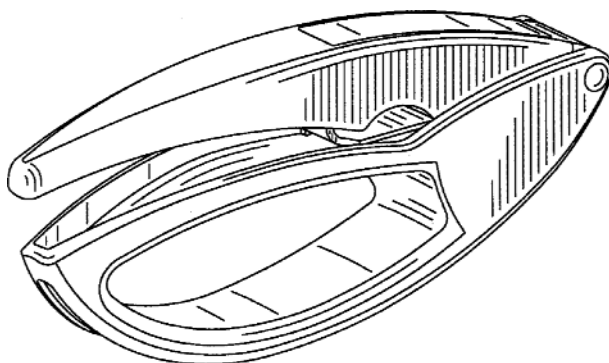

D.24/2002

Cl. 7-99 **128 977** 12.08.2002
 3 Designs – Wegwerfoberfläche
 S. C. Johnson Home Storage, Inc., 1525 Howe Street,
 Racine / WI (US). Rechtsnachfolgerin der Designer
 Bryan L. Ackerman, Michigan; William E. LeBoeuf, Michigan
 und Virginia D. Karul, Racine.
 Vertr.: E. Blum & Co, Zürich
 Prior.: USA 12.02.2002

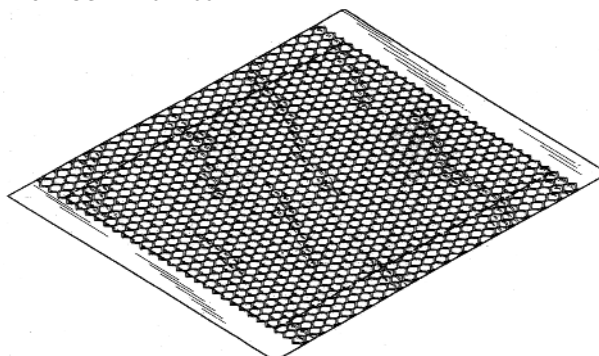

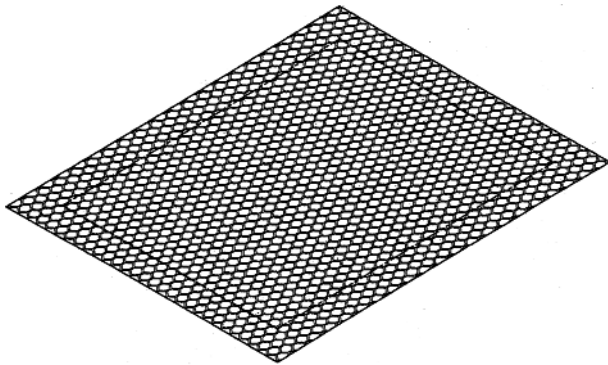
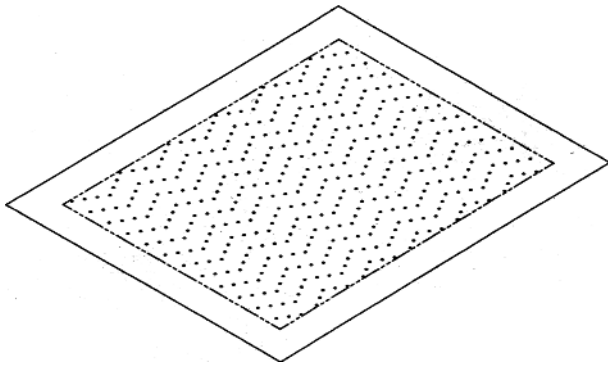

A-1034/02amsr

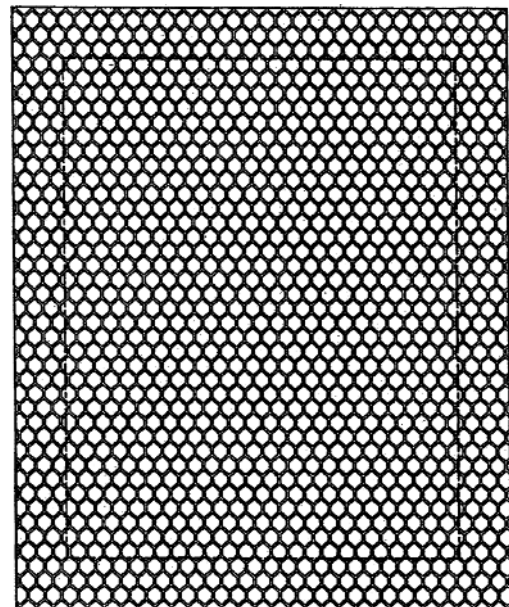
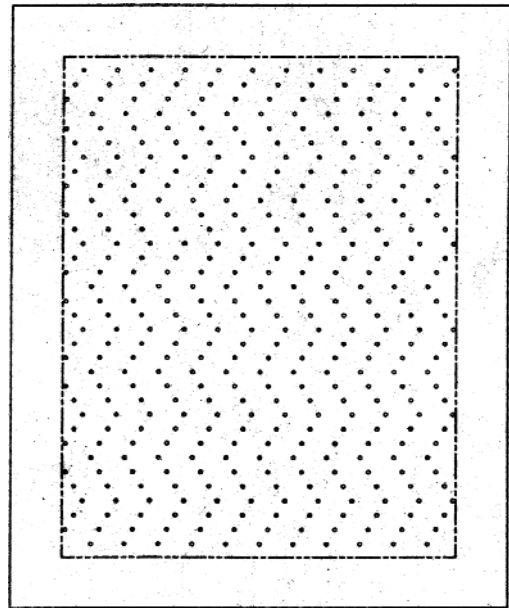
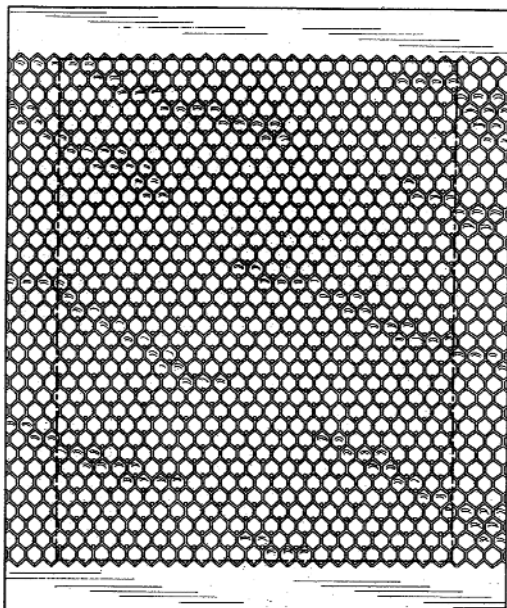

A-1034/02bmsr

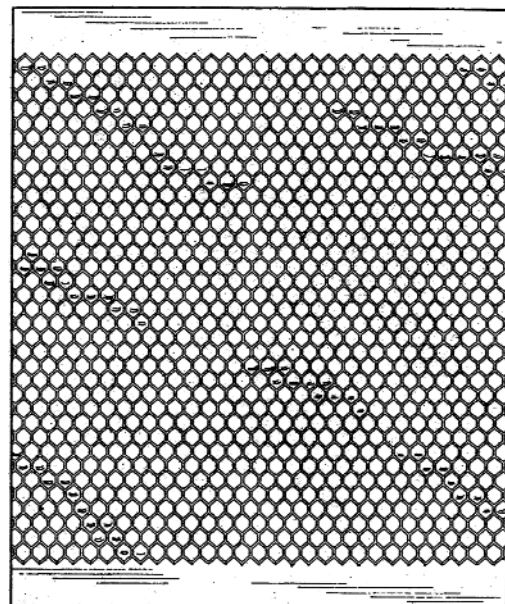

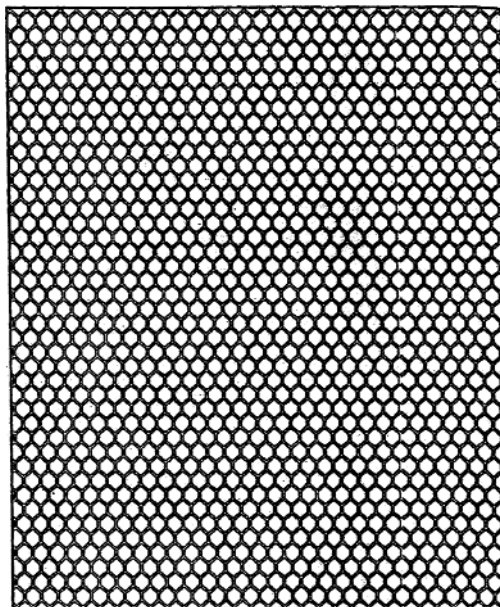
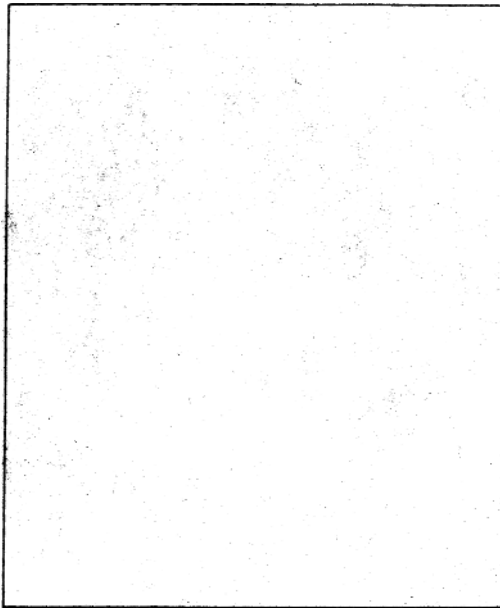

A-1034/02cmsr

Cl. 8-03 **128 978** 06.08.2002
 1 Design – Sägeblatt
 Kapman AB, Sandviken (SE). Rechtsnachfolgerin des
 Designers Per Robertsson, Lidköping.
 Vertr.: Bovard AG, Bern
 Prior.: Schweden 29.04.2002

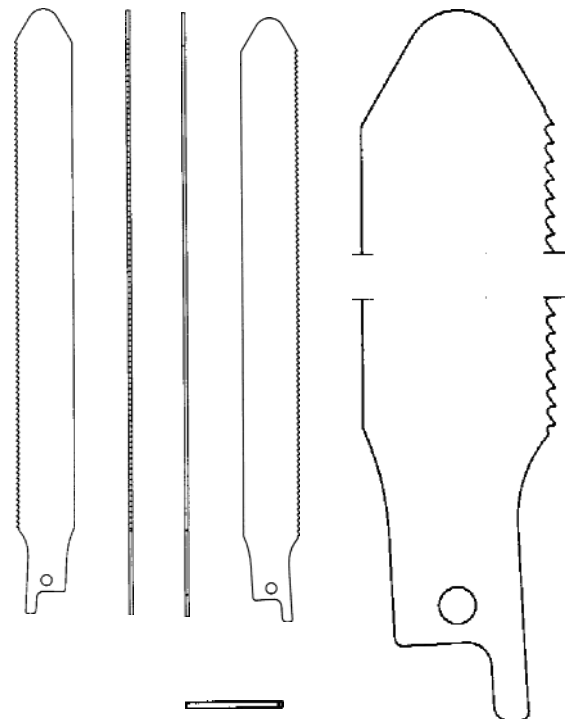
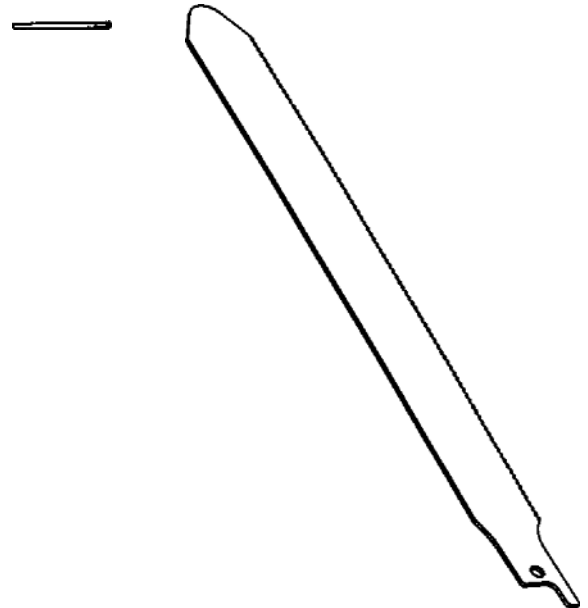

1

Cl. 8-03 **128 979** 09.08.2002
 1 Design – Schneidegerät
 The Antioch Company, 888 Dayton Street, P.O. Box 28,
 Yellow Springs / OH (US). Rechtsnachfolgerin der
 Designerin Carmen Lira-Nunez, St. Cloud
 Vertr.: Frei Patentanwaltsbüro AG, Zürich
 Prior.: USA 13.02.2002

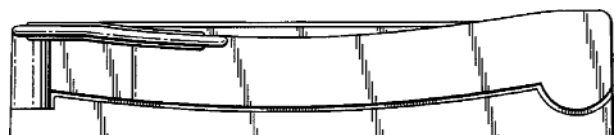

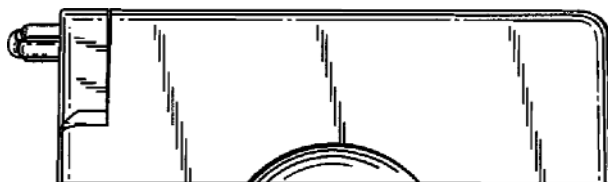
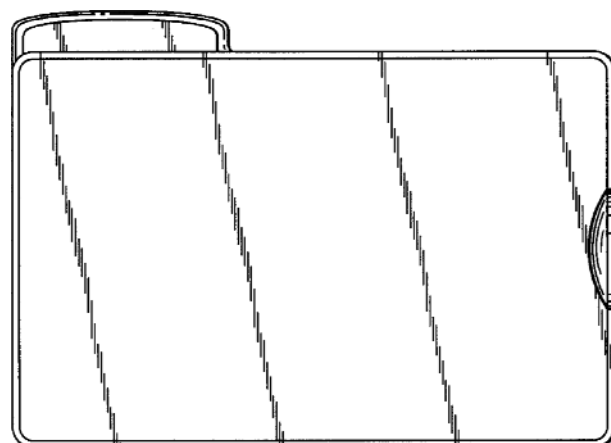
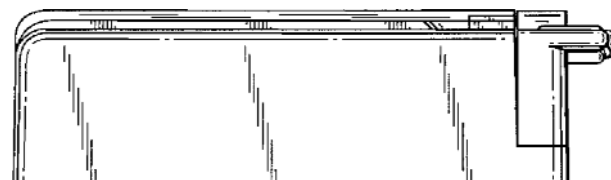
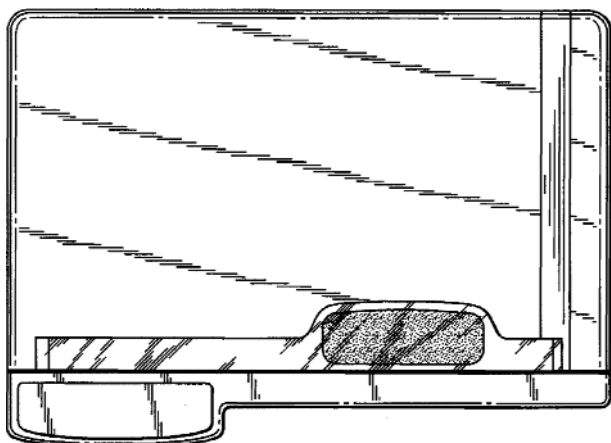
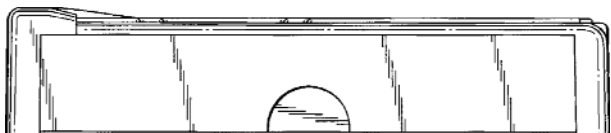
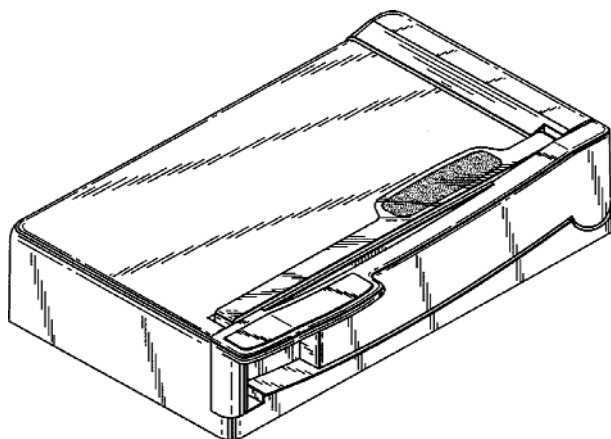

D0083CH

Cl. 9-01 **128 980** 24.06.2002
 1 Modell – Flasche – offen
 Pomdor AG, Bahnhofstrasse 25, 3629 Kiesen.
 Rechtsnachfolgerin des Urhebers Altoplast AG, Netstal
 Vertr.: Fuhrer Marbach & Partner, Bern

Cl. 9-03 **128 981** 28.06.2002
 3 Modelle – Kosmetikinstrumentenverpackung – offen
 Outils Rubis SA, Via Lische, 6855 Stabio.
 Vertr.: Ritscher & Partner AG, Zürich

Cl. 9-03 **128 982** 05.08.2002
 1 Design – boîte à pilules
 Wyeth, Five Giralda Farms, Madison / NJ (US). Ayant cause des
 designers Alexander James Sinton, Doylestown et Paul Raymond
 Finkelston, Philadelphia.
 Mand.: Bugnion SA, Genève
 Prior.: USA 06.02.2002

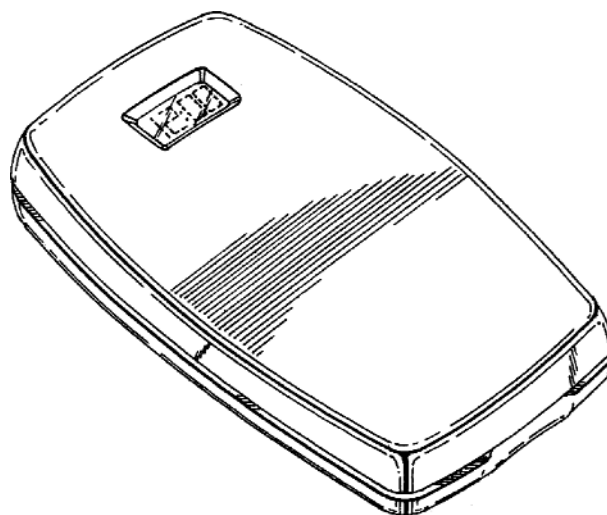
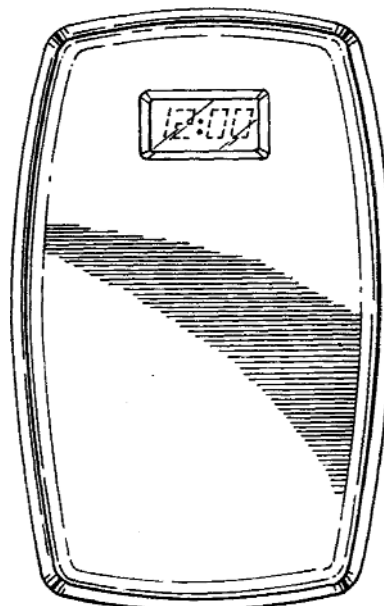

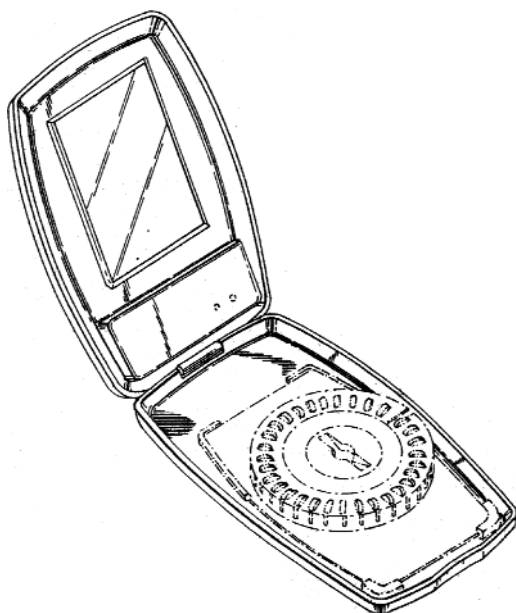
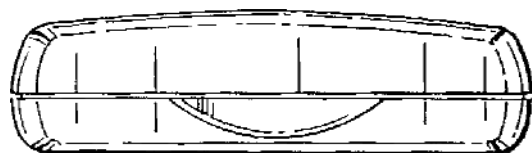
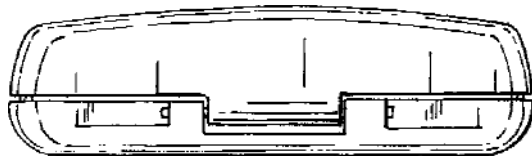
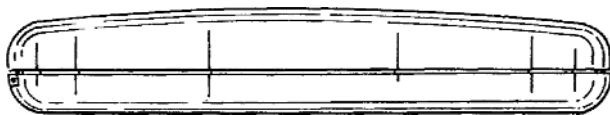
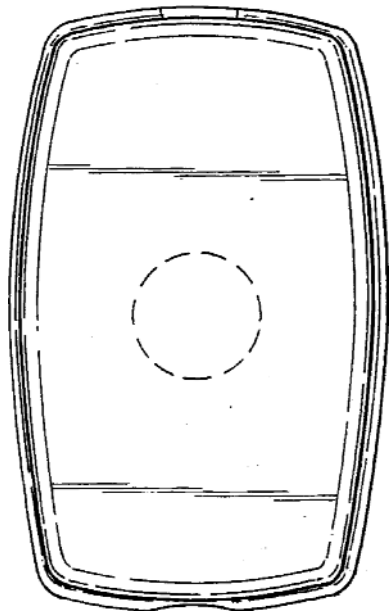

4.W328.32CH.1

Cl. 9-03 **128 983** 06.08.2002
1 Design - Traggestell für Getränkeflaschen
Super-Plast Ltd., P. O. Box 83, Petach-Tikva (IL).
Rechtsnachfolgerin des Designers Rony Shatan, Tel Aviv
Vertr.: Isler & Pedrazzini AG, Zürich
Prior.: Israel 12.02.2002

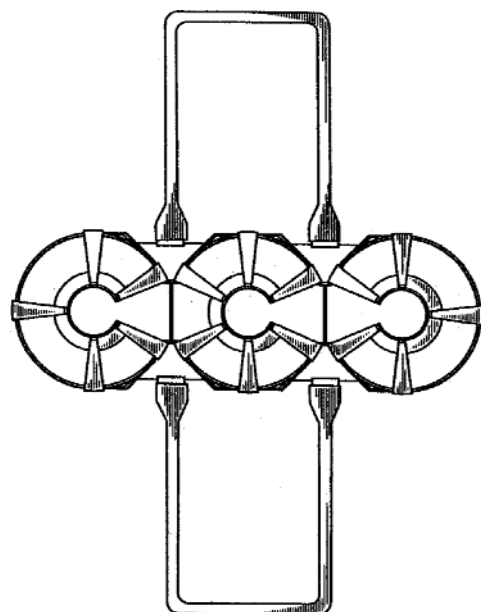
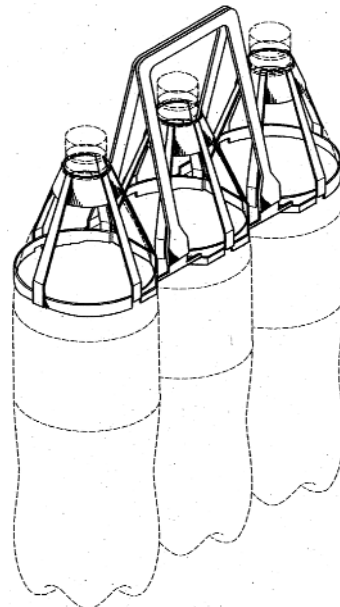
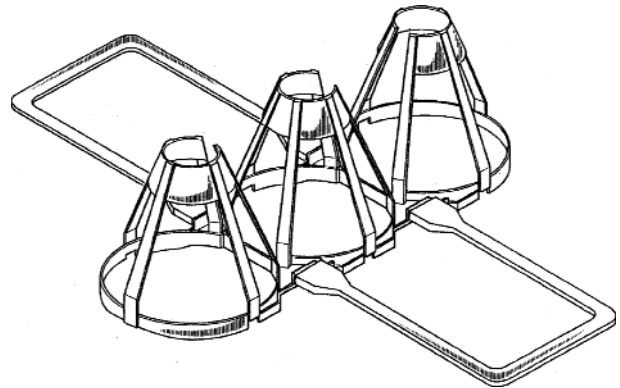

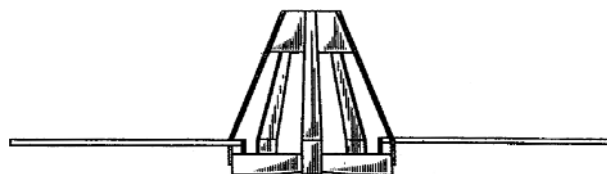
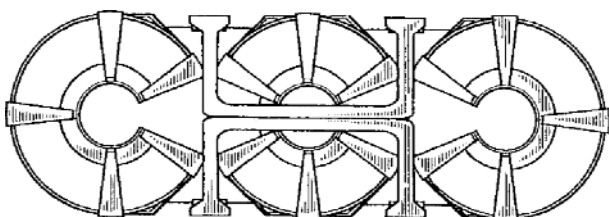
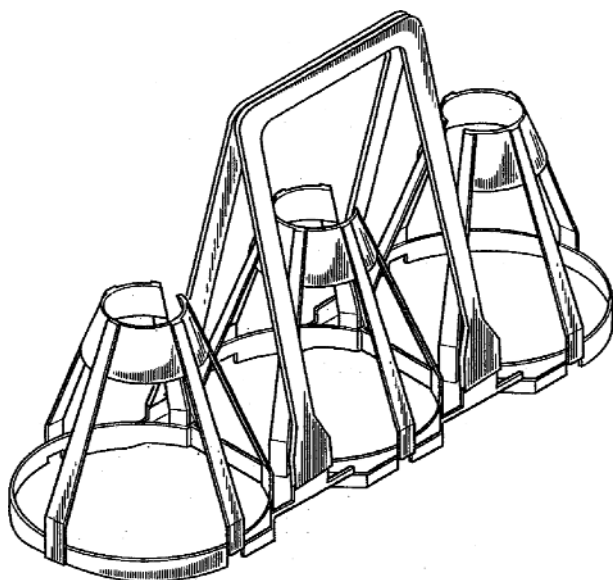
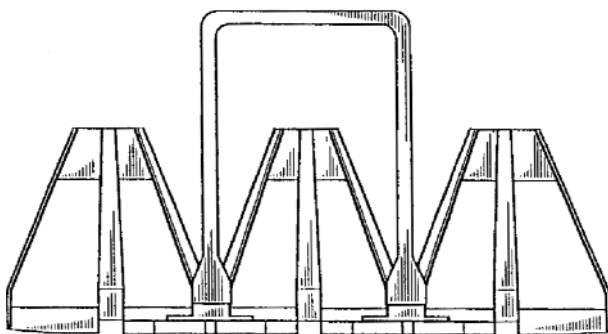
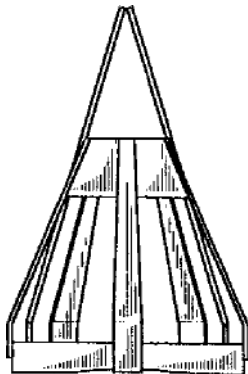
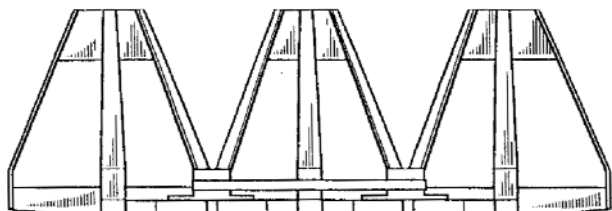

M12648

Cl. 10-02 128 984 09.08.2002

1 Design - Uhr
Walter Haselberger, Apartado Correos 69, Vergel (ES).
Vertr.: Büchel, v. Révy & Partner, Wil
Prior.: Deutschland 18.02.2002



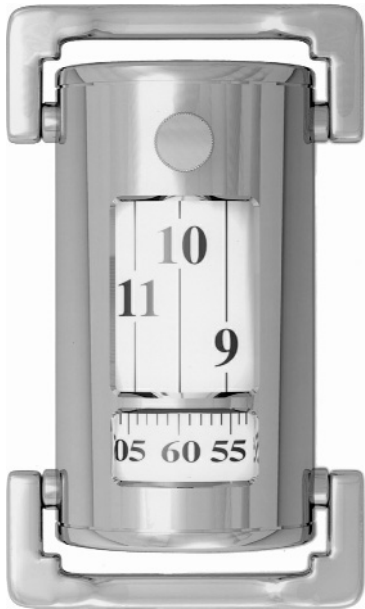

WE-1868-CH

Cl. 12-11 128 985 26.07.2002
1 Design – Regenschutz für Sattel
Hes Idea AG, Rennweg 14-16, 8001 Zürich. Rechtsnachfolgerin
des Designers Thomas Killer, Zürich.
Vetr.: Harry Hes, Zürich



1013973

Cl. 13-02 128 986 06.08.2002
 1 design – chargeur de voyage
 Philip Morris Products Inc., 3601 Commerce Road,
 Richmond / VA (US). Ayant cause des designers Marc R.
 Chemla, Midlothian; Charles T. Higgins, Richmond; Seiichi
 Kawakami, Hyogo; Tomonori Sakamoto, Hyogo; Masato Sano,
 Hyogo et Takahide Takeda, Hyogo.
 Mand.: Bovard SA, Berne
 Prior.: USA 21.02.2002

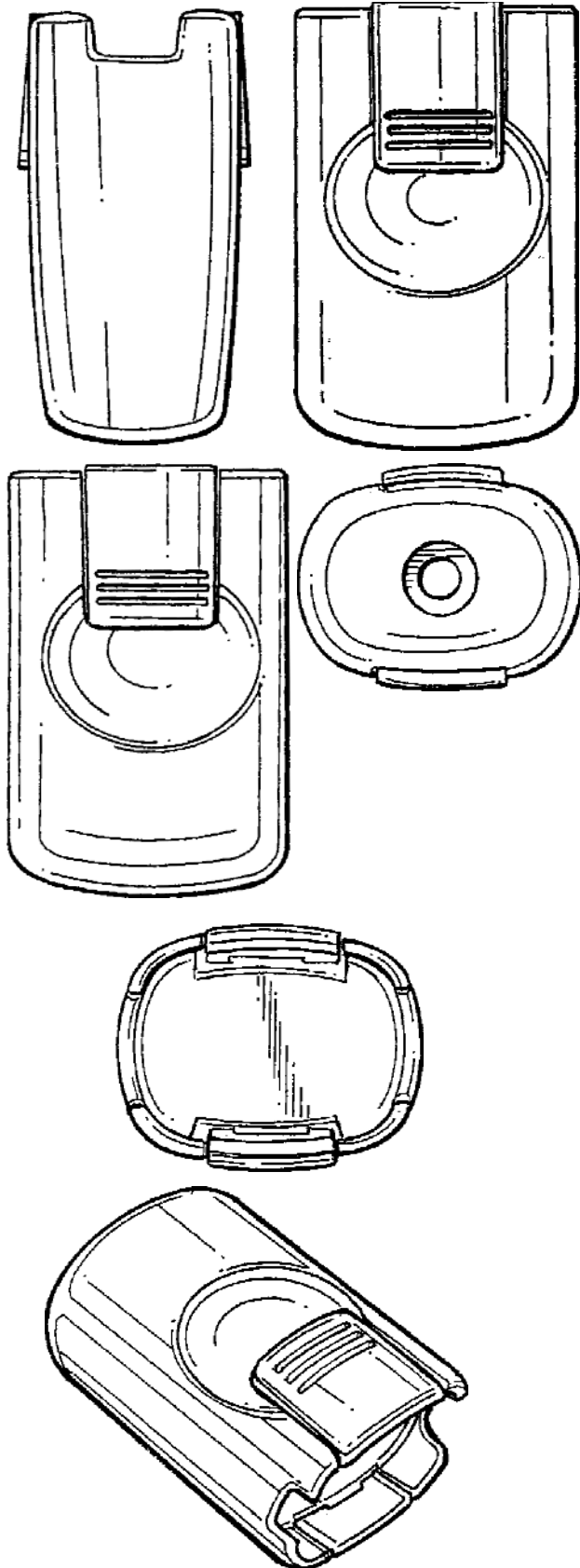

1

Cl. 20-03 128 987 31.07.2002
 4 Designs – Schilderbemusterung
 Walter Sirusas, Bannstrasse 2, 6312 Steinhausen.

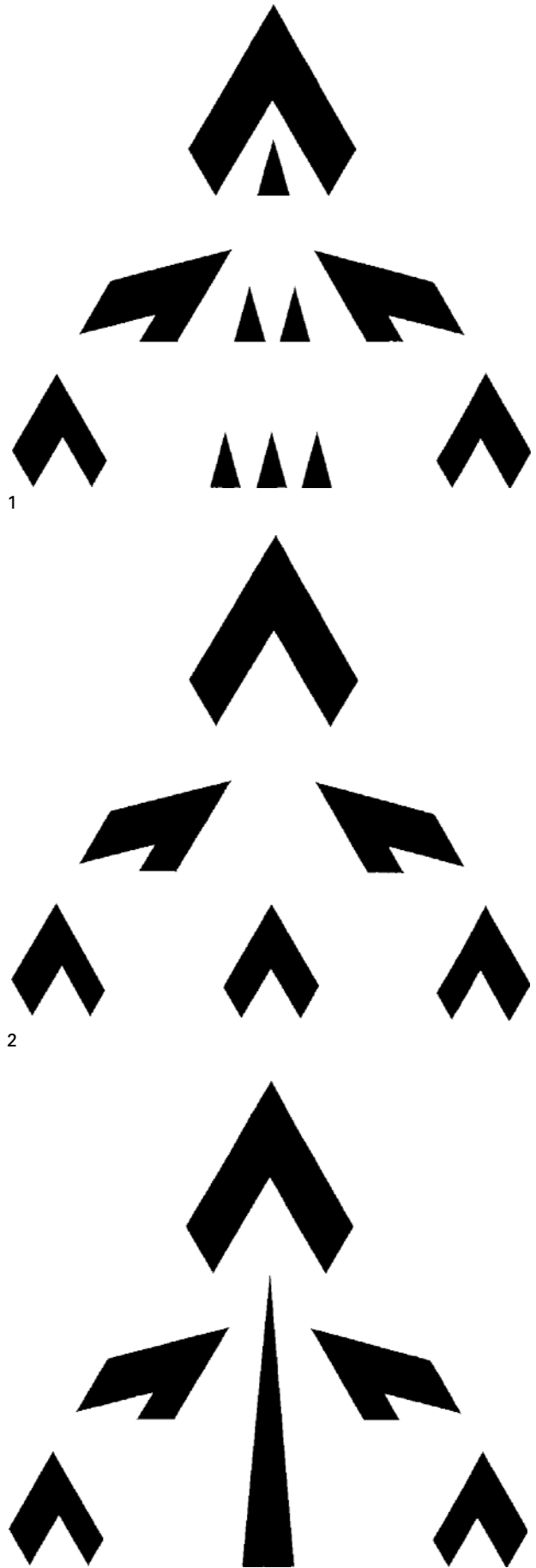

1

2

3

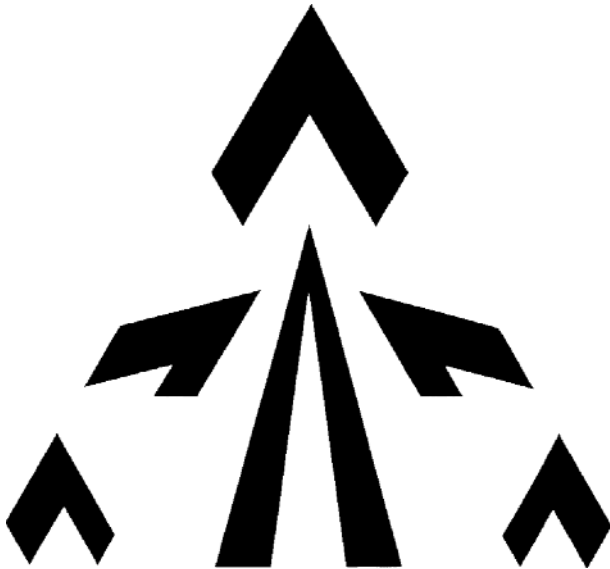

4

Cl. 23-04 **128 988** 18.06.2002
 1 modèle – dispositif pour le rafraîchissement de l'air – ouvert
 S. C. Johnson & Son, Inc., 1525 Howe Street, Racine / WI (US).
 Mand.: Kirker & Cie S.A., Genève-Thônex

Cl. 26-04 **128 989** 26.08.2002
 1 Design – Leuchtröhrenhalterung
 Durlum-Leuchten GmbH, An der Wiese 5, Schopfheim (DE).
 Rechtsnachfolgerin des Designers Adrian Erismann,
 Müchwilen.
 Vertr.: Hans Rudolf Gachnang, Frauenfeld
 Prior.: Deutschland 26.06.2002



1

Cl. 30-03 **128 990** 14.08.2002
 3 Designs – Vogelfutterstellen
 Heimstätten Wil, Zürcherstrasse 30, 9501 Wil SG.
 Rechtsnachfolgerin der Designer Brigitta Martig-Imhof,
 Wetzikon und Benedikt Martig-Imhof, Wetzikon.



langbank



steck-bar



hang-on

Cl. 30-99 **128 991** 07.08.2002
 1 Design – Katzenklorand
 Masterfoods AG, Baarerstrasse 6, 6340 Baar.
 Rechtsnachfolgerin des Designers Michael Hardt,
 Saarbrücken.
 Vertr.: A. W. Metz & Co. AG, Zürich

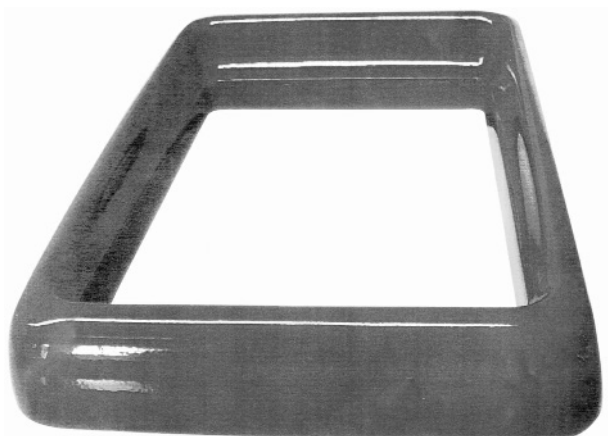

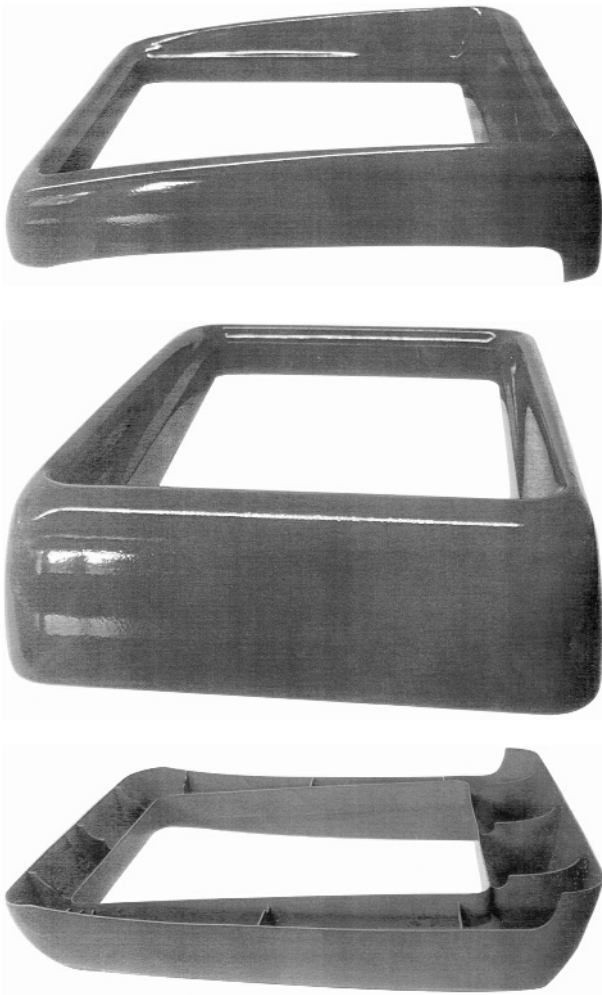

8420-CH

Verlängerungen Prolongations Prolongazioni

116 086 Cl. 10-01 1Design

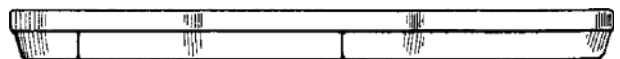
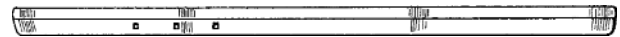
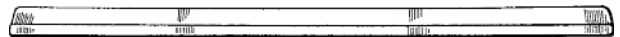
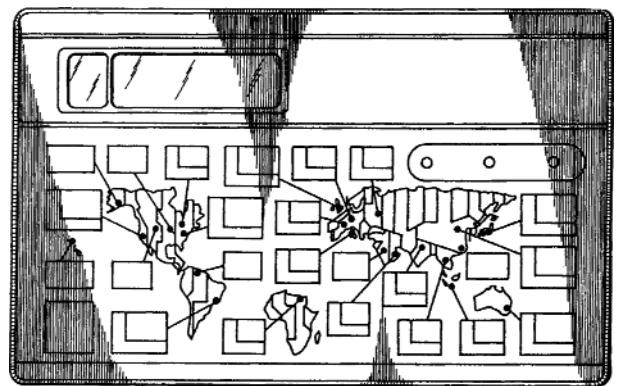
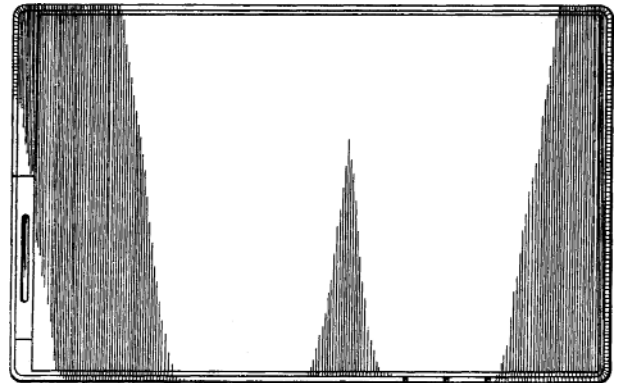

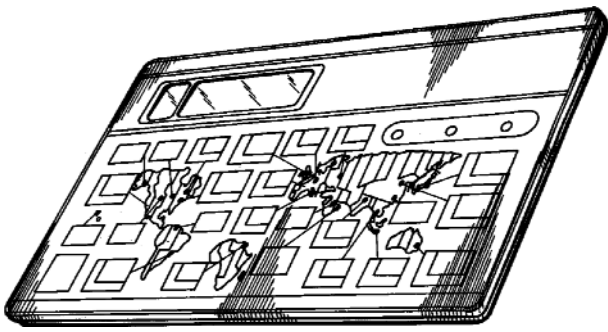

M6656.04

116 120 Cl. 7-01 2 Designs

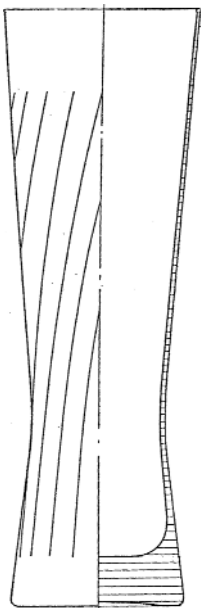

111341-1

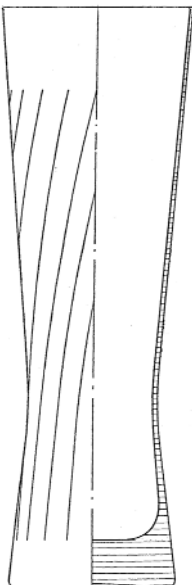

111341-2

116 139 Cl. 18-99 1 Design

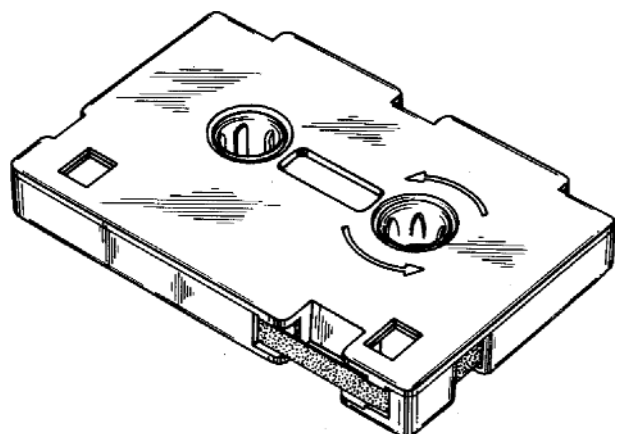
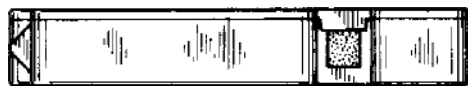
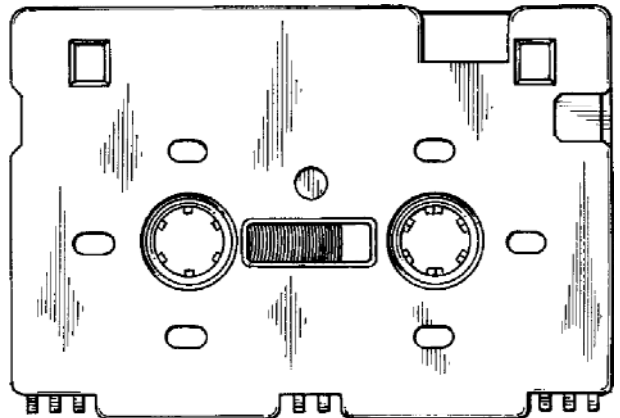
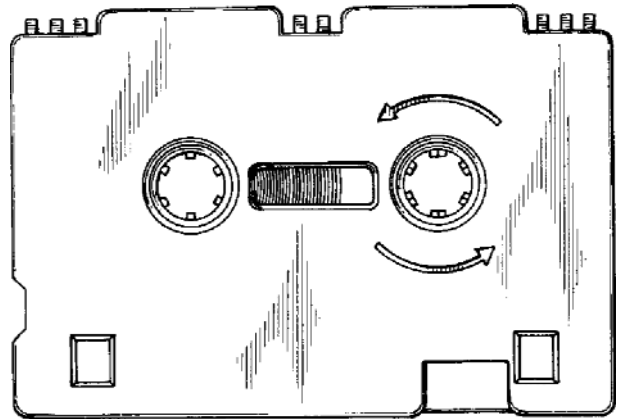
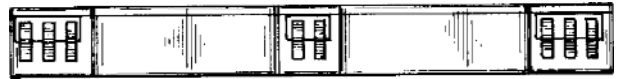

M06802.12

116 143 Cl. 24-02 1 Design

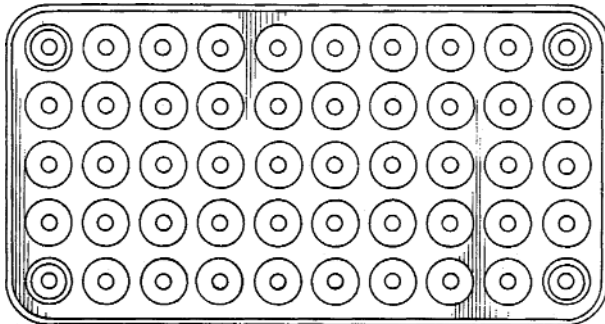
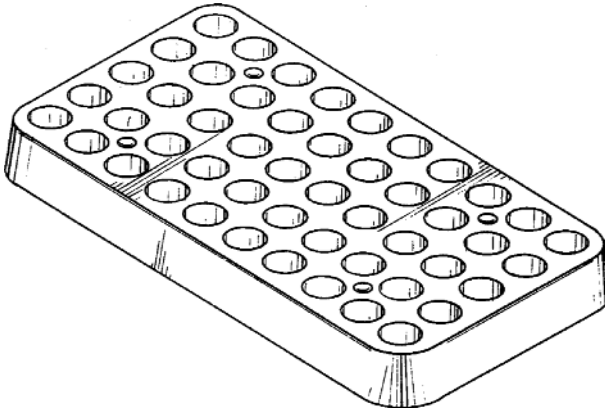
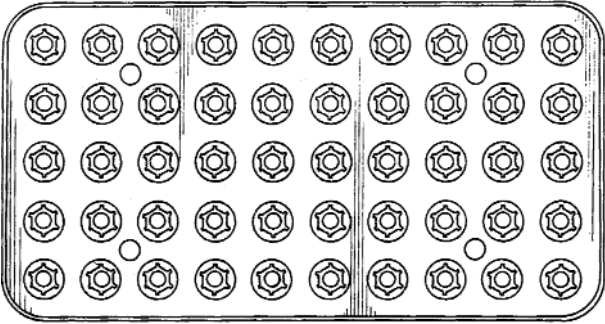
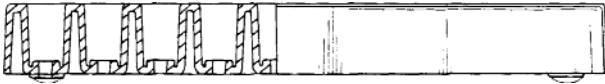

M-1957/87

116 144 Cl. 24-02 1 Design

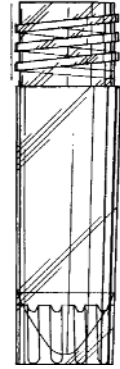
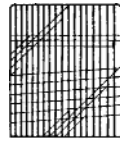
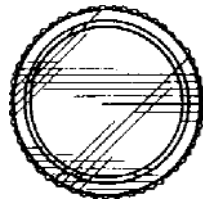
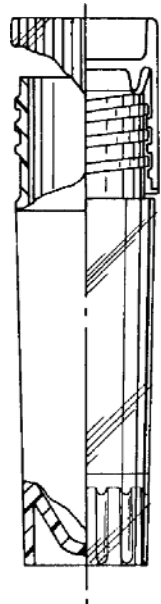

M-1956/87

116 226 Cl. 9-05 1 Design

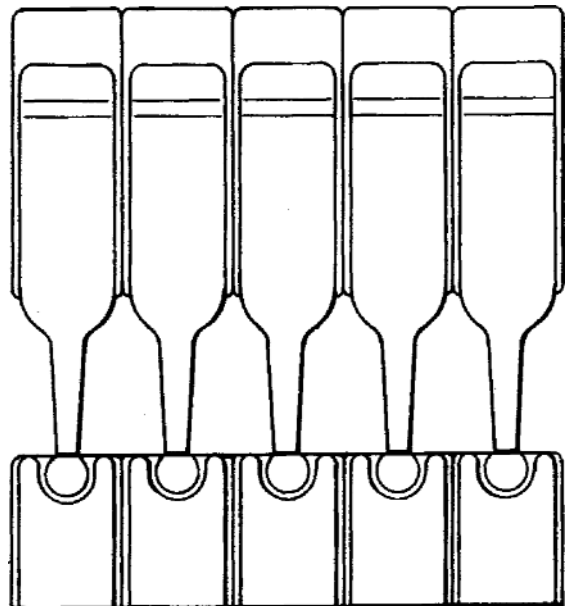
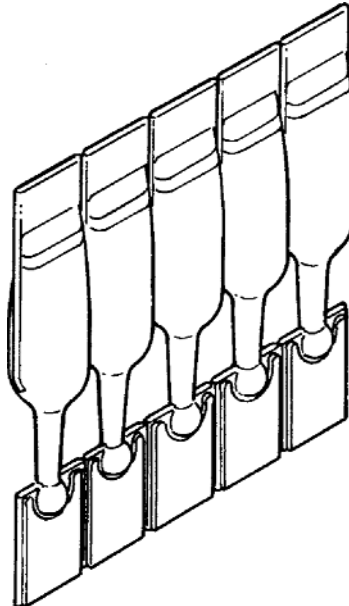

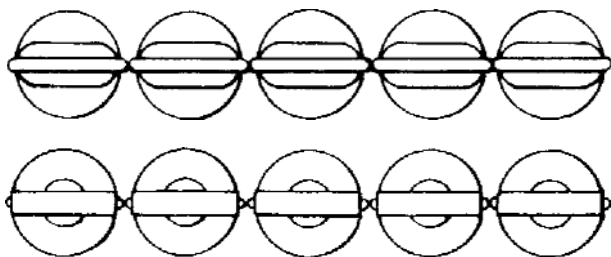

2419

116 299	Cl. 10-02	1 Design
119 953	Cl. 25-01	11 Designs
120 146	Cl. 9-03	1 design
120 286	Cl. 12-02	1 Design
124 415	Cl. 8-03	12 designs
124 422	Cl. 10-07	1 Design
124 428	Cl. 12-08	1 Design
124 473	Cl. 23-02	1 Design
124 482	Cl. 28-03	5 Designs
124 507	Cl. 21-01	1 Design
124 657	Cl. 21-01	1 Design
124 694	Cl. 25-02	1 Design
124 696	Cl. 25-03	2 Designs

Mutationen Modifications Modificazioni

116 279Firmaänderung in: USM Holding AG, Schlossgutweg 39,
3073 Gümligen

Vertr.: Keller & Partner Patentanwälte AG, Bern

Löschungen Radiations Radiazioni

119 571	Cl. 9-03	1 Design
119 577	Cl. 10-07	2 designs
119 578	Cl. 10-07	2 designs
119 585	Cl. 16-03	1 Design
119 590	Cl. 20-02	1 design
119 593	Cl. 25-01	3 Designs
119 639	Cl. 10-02	1 Design
123 959	Cl. 6-01	1 Design
123 963	Cl. 7-01	1 Design
123 972	Cl. 10-02	1 design
123 973	Cl. 10-02	1 design
123 974	Cl. 10-02	1 design
123 975	Cl. 10-02	1 Design
123 986	Cl. 19-04	2 designs
124 009	Cl. 7-01	1 Design
124 017	Cl. 11-01	23 designs
124 022	Cl. 24-99	1 Design
124 036	Cl. 7-01	2 Designs
124 058	Cl. 10-07	2 designs
124 112	Cl. 21-02	1 Design
124 128	Cl. 7-01	1 Design
124 150	Cl. 21-02	1 Design
124 151	Cl. 21-02	2 Designs
124 154	Cl. 25-01	5 Designs