

## Nationale Hinterlegungen

In der folgenden Liste werden die beim Eidgenössischen Institut für Geistiges Eigentum hinterlegten Designs publiziert. Dabei sind der Reihe nach angegeben:

- internationale Klassenangaben
- Hinterlegungsnummer
- Hinterlegungsdatum
- Allenfalls Aufschub der Veröffentlichung
- Anzahl der hinterlegten Designs
- Bezeichnung
- Name und Wohnsitz des Hinterlegers oder der Hinterlegerin
- gegebenenfalls Name und Wohnsitz des Designers oder der Designerin
- Name und Geschäftssitz des allfälligen Vertreters oder der Vertreterin
- gegebenenfalls Prioritätsangaben
- gegebenenfalls Beschreibungstext
- Ordnungsnummer
- Reproduktion des Designs

## Internationale Hinterlegungen

Die bei der Weltorganisation für geistiges Eigentum in Genf hinterlegten Muster und Modelle mit Benennung Schweiz geniessen den gleichen Schutz wie national hinterlegte Designs. Sie werden jeweils im Blatt «Bulletin des dessins et modèles internationaux» veröffentlicht. Dieses Publikationsorgan ist deshalb für eine vollständige Recherche unbedingt beizuziehen.

## Topographien

Angaben über die vom Eidgenössischen Institut für Geistiges Eigentum eingetragenen Topographien von Halbleitererzeugnissen werden in folgender Anordnung aufgeführt:

- Eintragsnummer
- Anmeldedatum
- Bezeichnung
- Name und Wohnsitz des Anmelders oder der Anmelderin
- gegebenenfalls Name und Wohnsitz des Herstellers oder der Herstellerin
- Name und Geschäftssitz des oder der allfälligen Bevollmächtigten
- Datum und Ort einer allfälligen ersten geschäftlichen Verbreitung der Topographie

## Dépôts nationaux

Les designs déposés à l'Institut Fédéral de la Propriété Intellectuelle sont publiés dans la liste qui suit. Les indications y relatives sont mentionnées dans cet ordre:

- indications des classes internationales
- numéro de dépôt
- date de dépôt
- le cas échéant, ajournement de la publication
- nombre des designs déposés
- désignation
- nom et domicile du/de la déposant/e
- le cas échéant, nom et domicile du/de la designer
- nom et domicile de l'éventuel/le mandataire
- le cas échéant, indication de priorité
- le cas échéant, description du design
- numéro attribué à chaque design
- reproduction du design

## Dépôts internationaux

Les dessins et modèles déposés à l'Organisation Mondiale de la Propriété Intellectuelle à Genève qui désignent la Suisse jouissent de la même protection que les dépôts nationaux. Ils sont chaque fois publiés dans la feuille «Bulletin des dessins et modèles internationaux». Pour une recherche complète, il est indispensable de consulter ledit organe de publication.

## Topographies

Les indications concernant les topographies des produits semi-conducteurs, enregistrées par l'Institut Fédéral de la Propriété Intellectuelle, sont énumérées dans l'ordre suivant:

- numéro d'enregistrement
- date de dépôt
- désignation
- nom et domicile du/de la déposant/e
- le cas échéant, nom et domicile du/de la producteur/trice
- nom et domicile de l'éventuel/le mandataire
- date et lieu d'une éventuelle première mise en circulation de la topographie

## Depositi nazionali

Nella lista seguente vengono pubblicati i design depositati presso l'Istituto Federale della Proprietà Intellettuale. Sono menzionati nel seguente ordine:

- indicazioni delle classi internazionali
- numero di deposito
- data del deposito
- se del caso, indicazione che la pubblicazione è stata differita
- numero dei design depositati
- designazione
- nome e domicilio del depositante
- se del caso, nome e domicilio del designer
- nome e sede di un eventuale mandatarario
- se del caso, indicazioni di priorità
- se del caso, descrizione del design
- numero d'ordine
- riproduzione del design

## Depositi internazionali

I disegni e modelli depositati presso l'Organizzazione Mondiale della Proprietà Intellettuale a Ginevra con denominazione Svizzera godono della medesima protezione del deposito nazionale. Essi vengono pubblicati ogni volta nel foglio «Bulletin des dessins et modèles internationaux». Quest'organo di pubblicazione è da consultare se si vuole effettuare una ricerca completa.

## Topografie

Le indicazioni concernenti le topografie di prodotti a semiconduttori depositati presso l'Istituto Federale della Proprietà Intellettuale sono menzionate nell'ordine seguente:

- numero di registrazione
- data del deposito
- designazione
- nome e domicilio del/la richiedente
- se del caso, nome e domicilio del/la produttore/trice
- nome e sede di un eventuale mandatarario
- data e luogo di un'eventuale prima messa in circolazione della topografia

### Hinterlegungen

### Dépôts

### Deposit

Cl. 01-01                      **130 754**                      21.05.2004  
 1 Design – Reis-Sandwich  
 Hinterleger: Shinsen GmbH, Staffelstrasse 10, 8045 Zürich  
 Designer: Dino Bacchetta, Forch ZH  
 Vertreter: Thouvenin Rechtsanwälte, 8034 Zürich

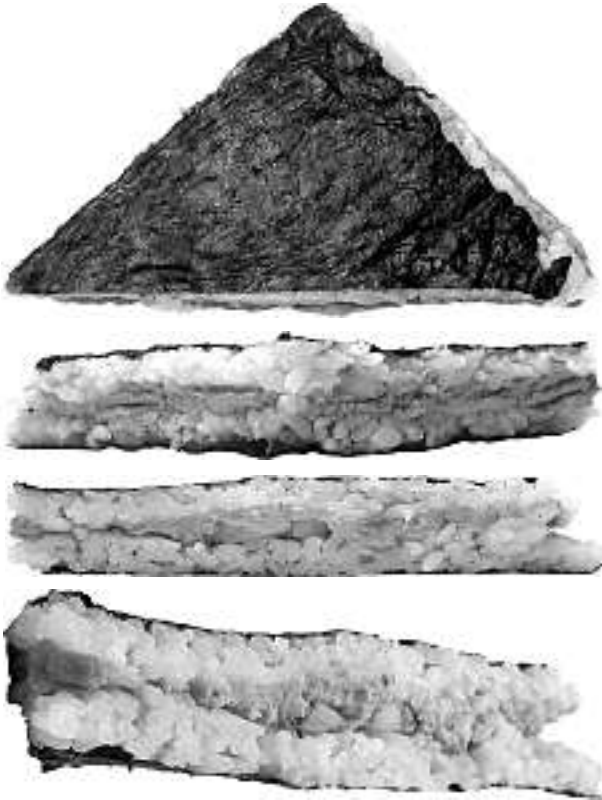

rice-sandwich

Cl. 02-07                      **130 755**                      18.05.2004  
 1 Design – Gürtel  
 Hinterleger: XTRADSIGN AG, Oberwiler Kirchweg 6,  
 6300 Zug  
 Designer: Karin Böhnke, Luzern



Cl. 03-01                      **130 756**                      13.05.2004  
 1 Design – Tasche  
 Hinterleger: Christian Lees, Wasserfurrenstrasse 14,  
 8600 Dübendorf

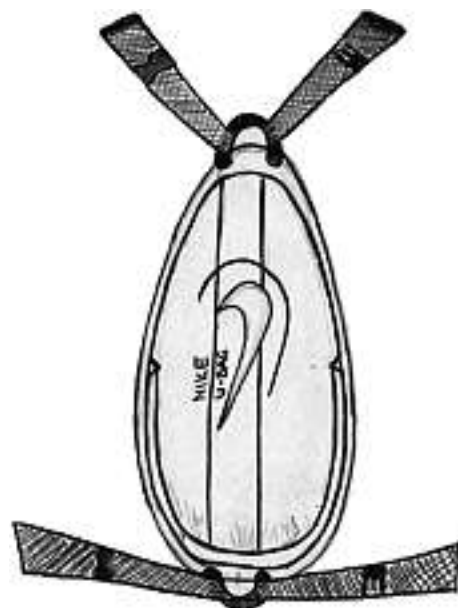
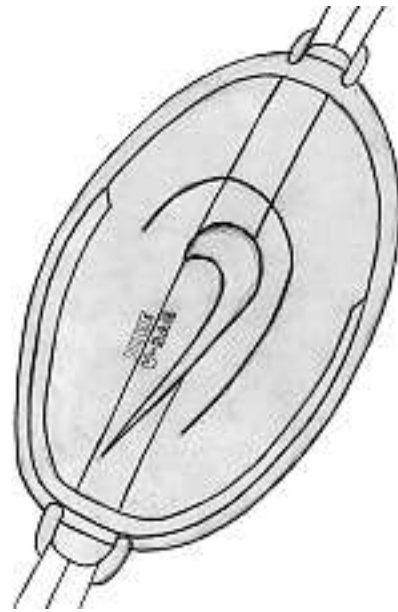

Universal-Bag

Cl. 04-02                      **130 757**                      13.05.2004  
 4 Design – Zahnbürstenkopf  
 Hinterleger: The Gillette Company, Prudential Tower  
 Building, 40th Floor, Boston, MA 02199, US  
 Designer: William R. Brown, jr., Peabody; Alexander T.  
 Chenvainu, Sudbury; Thomas A. Christman, Lexington  
 Vertreter: E. Blum & Co., 8044 Zürich  
 Priorität: US, 18.11.2003

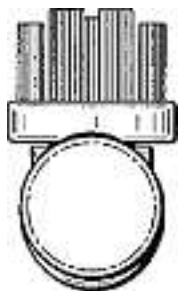
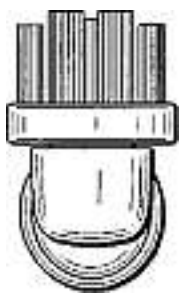

A-2004/1020a

A-2004/1020b

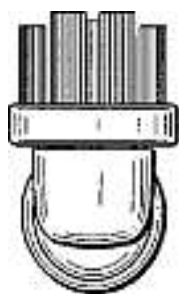
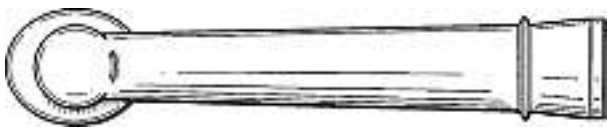
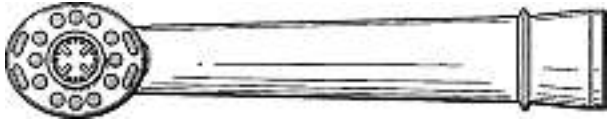
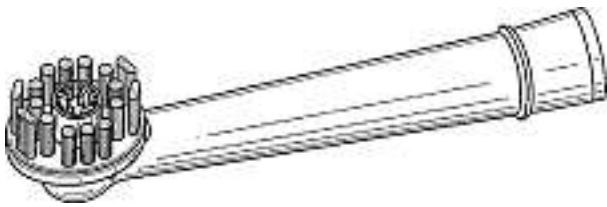

A-2004/1020c

A-2004/1020d

Cl. 06-01 **130 758** 14.04.2004  
 6 design – sedia  
 Depositante: Airnova srl, via Puccini 32/2  
 Campolongo al Torre, UD, IT  
 Designer: Daniele Furlan, Terzo D'Aquileia  
 Mandatario: Ing. C. Gaggini, Brevetti – Marchi,  
 6982 Agno  
 1 (siehe Farbteil Heftmitte)  
 2 (siehe Farbteil Heftmitte)  
 3 (siehe Farbteil Heftmitte)  
 4 (siehe Farbteil Heftmitte)  
 5 (siehe Farbteil Heftmitte)  
 6 (siehe Farbteil Heftmitte)

Cl. 06-01 **130 759** 14.05.2004  
 2 Design – Liege  
 Hinterleger: Micheline Hauchecorne, Insstrasse 15 B,  
 3237 Brüttelen

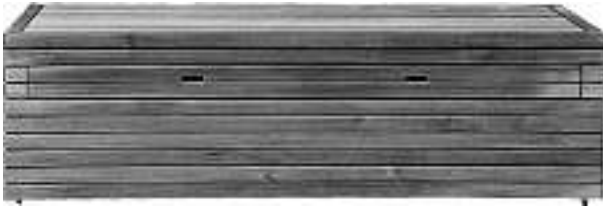

r-s 1



r-s 2

Cl. 06-01 **130 760** 22.05.2004  
 1 design – chaise  
 Déposant: Audrey Drexler, 15d, route de Saint-Légier,  
 1800 Vevey  
 Priorité: FR, 04.05.2004



1

Cl. 06-03 06-04 **130 761** 25.05.2004  
 2 Design – Bürotisch, Regal  
 Hinterleger: Moviva AG, Neuhofstrasse 25, 6342 Baar  
 Designer: Bruno Wetterwald, Luzern



IN 01.2004 T



IN 01.2004 R

Cl. 06-06 **130 762** 17.05.2004  
 3 Design – Möbelauszüge, Möbelteil  
 Hinterleger: Beat Augsburg, Maienstrasse 49, 4600 Olten



1



2



3

Cl. 07-02 **130 763** 10.05.2004  
 1 Design – Grill  
 Hinterleger: Arif Boyunegri, Birmensdorferstrasse 561,  
 8055 Zürich  
 Vertreter: Cuneyt Gümüsdere, 8800 Thalwil

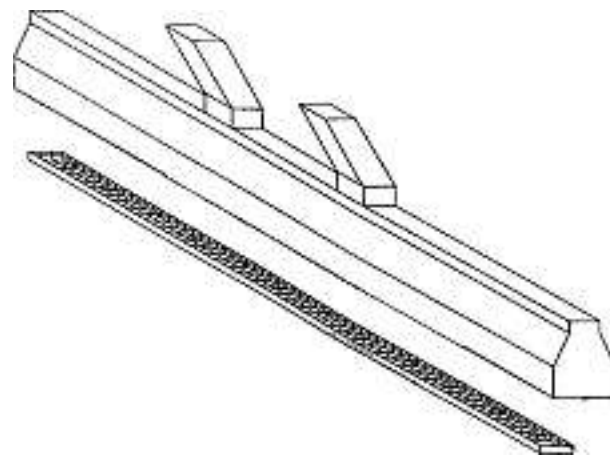
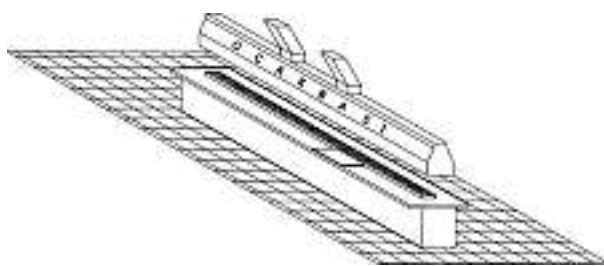
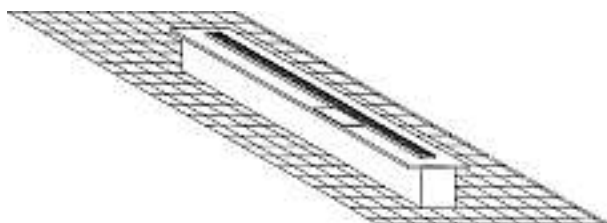

OCAKBASI

Cl. 07-02 **130 764** 25.05.2004  
 1 design – bouilloire  
 Déposant: Antoine Cahen, c/o Les Ateliers du Nord, Place du  
 Nord 2, 1005 Lausanne





1

Cl. 07-02      **130 765**      25.05.2004  
 1 design – machine à café  
 Déposant: Société des Produits Nestlé SA, 1800 Vevey  
 Designer: Stefan Koitzsch, Darmstadt; Micha Daniels, Frankfurt  
 Mandataire: Nestec S.A., 1800 Vevey



FL 54846

Cl. 07-99      **130 766**      24.05.2004  
 1 Design – Dosenöffner  
 Hinterleger: MOHA Moderne Haushaltswaren AG,  
 Tannholzstrasse 14, 3052 Zollikofen  
 Designer: Ulrich Greiner, Elchingen  
 Vertreter: Patentanwälte Feldmann & Partner AG,  
 8152 Glattbrugg





1

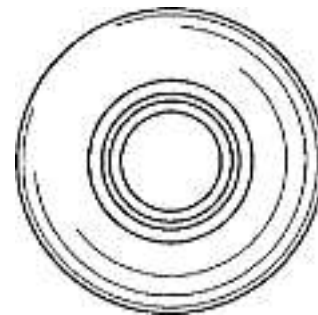
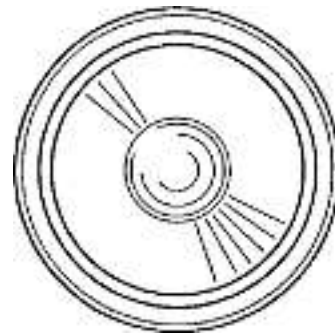

Cl. 09-01                      **130 767**                      01.06.2004  
 1 Design – Flasche  
 Hinterleger: Ball Corporation, 10 Longs Peak Drive,  
 Broomfield, CO 80021-2510, US  
 Designer: John E. Livingston, Denver; Erik E. Gatewood,  
 Louisville; Bryan D. Tyree, Thornton; Michael L. Vaughn,  
 Broomfield  
 Vertreter: Patentanwälte, Schaad, Balass, Menzl & Partner AG,  
 8034 Zürich  
 Priorität: US, 21.01.2004

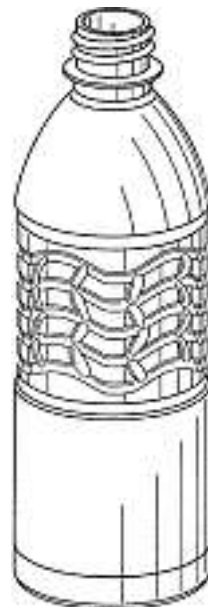
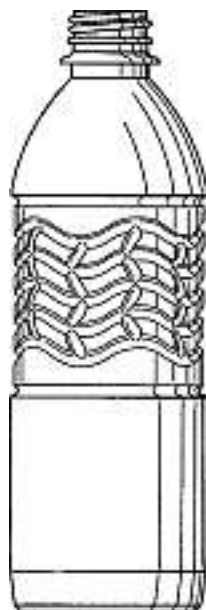

1

Cl. 09-01                      **130 768**                      08.06.2004  
 1 design – récipient  
 Déposant: Société des Produits Nestlé SA, 1800 Vevey  
 Designer: Philippe Guignard, Vevey  
 Mandataire: Nestec S.A., 1800 Vevey  
 FL 54956 (siehe Farbteil Heftmitte)



Cl. 09-03 130 769 07.06.2004  
 1 design – conteneur  
 Déposant: Société des Produits Nestlé SA, 1800 Vevey  
 Designer: Ermanno Capretti, Robbio  
 Mandataire: Nestec S.A., 1800 Vevey



FL54900

Cl. 09-05 130 770 13.05.2004  
 4 Design – Blisterpackungen  
 Hinterleger: Glaxo Group Limited, Glaxo Wellcome House,  
 Berkeley Avenue, Greenford/Middx, GB  
 Designer: Peter David Walker, Ware;  
 Paul Richard Smith, Ware  
 Vertreter: Isler & Pedrazzini AG, 8023 Zürich  
 Priorität: GB, 14.11.2003  
 M12899/1 (siehe Farbteil Heftmitte)  
 M12899/2 (siehe Farbteil Heftmitte)  
 M12899/3 (siehe Farbteil Heftmitte)  
 M12899/4 (siehe Farbteil Heftmitte)

Cl. 09-09 130 771 07.05.2004  
 1 Design – Papierkorb  
 Hinterleger: ASPEN MEDIA EVENTS Sàrl, 14, avenue de  
 Sécheron, 1202 Genève  
 Designer: Olivier Chauffat, Grandvaux;  
 Pierre Laurençon, Grandvaux  
 Vertreter: Troesch Scheidegger Werner AG, 8126 Zumikon  
 Priorität: FR, 07.11.2003  
 D300036 (siehe Farbteil Heftmitte)

Cl. 10-02 130 772 28.05.2004  
 2 design – montres  
 Déposant: Goldiam Sàrl, Vorbourg 48, CP 1019,  
 2800 Delémont  
 Designer: Henri Viatte, Delémont





5015.03 rectangle



5016.02 ronde tourbillon

Cl. 10-04 130 773 28.05.2004  
1 Design – Messgerät  
Hinterleger: Eidgenössische Technische Hochschule Zürich,  
ETH Transfer, Rämistrasse 101, 8092 Zürich  
Designer: Marcel Delavy, Zürich  
Vertreter: Siemens Schweiz AG, 8047 Zürich





2004M08873CH

Cl. 10-07 **130 774** 18.03.2004

1 design – quadrante d’orologio  
 Depositante: Aphrodite Agencies Ltd., Car and Road Safety System, St. Peter / Jersey, GB  
 Designer: Gian-Mario Rubboli, Milano  
 Mandatario: Ing. C. Gaggini, Brevetti – Marchi, 6982 Agno

Descrizione del design:  
 1. Quadrante per orologio da polso indicante le maree più le fasi lunari.  
 2. Quadrante tinto in colori sfumati dal blu al celeste-bianco.  
 1 (siehe Farbteil Heftmitte)

Cl. 10-07 **130 775** 19.05.2004

1 Design – Uhrarmband  
 Hinterleger: Hirsch Holding (Schweiz) AG, Nidaugasse 15, 2502 Biel/Bienne  
 Designer: Wolfgang Sima, Keutschach



10040

Cl. 10-07 **130 776** 25.05.2004

3 design – partie de montre  
 Déposant: José Labarga, rue du Levant 12, 2114 Fleurier

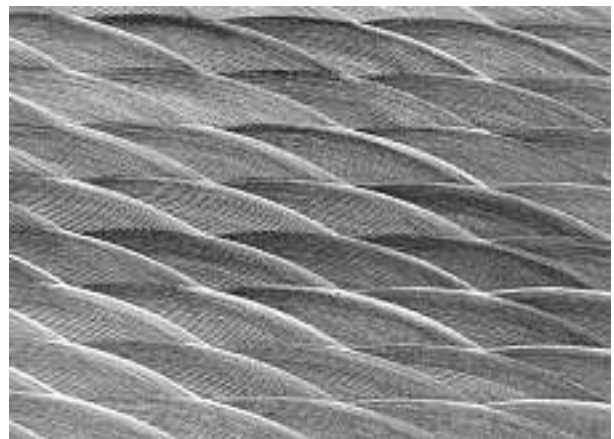

1001



1002

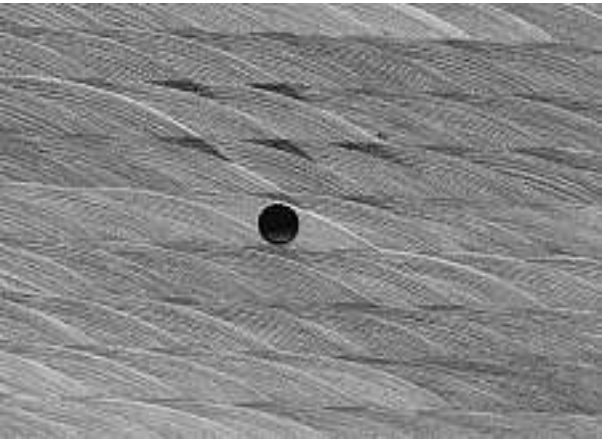

1003



M12894

Cl. 12-16                      **130 778**                      01.06.2004  
 1 Design – Fahrzeugrad  
 Hinterleger: Dr.Ing. h.c.F. Porsche, Aktiengesellschaft,  
 Porscheplatz 1, 70435 Stuttgart, DE  
 Designer: Randjit Bhambra, Tiefenbronn-Mühlhausen  
 Vertreter: Isler & Pedrazzini AG, 8023 Zürich  
 Priorität: DE, 19.12.2003



Cl. 12-16                      **130 779**                      01.06.2004  
 1 Design – Fahrzeugrad  
 Hinterleger: Dr.Ing. h.c.F. Porsche, Aktiengesellschaft,  
 Porscheplatz 1, 70435 Stuttgart, DE  
 Designer: Oliver Rosenbohm, Stuttgart  
 Vertreter: Isler & Pedrazzini AG, 8023 Zürich  
 Priorität: DE, 19.12.2003



M12905

Cl. 12-16

130 780

01.06.2004

1 Design – Fahrzeugrad

Hinterleger: Dr.Ing. h.c.F. Porsche, Aktiengesellschaft,

Porscheplatz 1, 70435 Stuttgart, DE

Designer: Michael Gallert, Stuttgart

Vertreter: Isler &amp; Pedrazzini AG, 8023 Zürich

Priorität: DE, 19.12.2003





M12906

Cl. 12-16 **130 781** 02.06.2004  
 2 design – rayons pour roues de bicyclettes  
 Déposant: Alpina Raggi S.p.A., Via C. Battisti, 60, Arcore (Milano), IT  
 Designer: Guido Cappellotto, Arcore  
 Mandataire: Novagraaf International SA, 1220 Les Avanchets  
 Priorité: EM, 30.01.2004



MB 51942/1

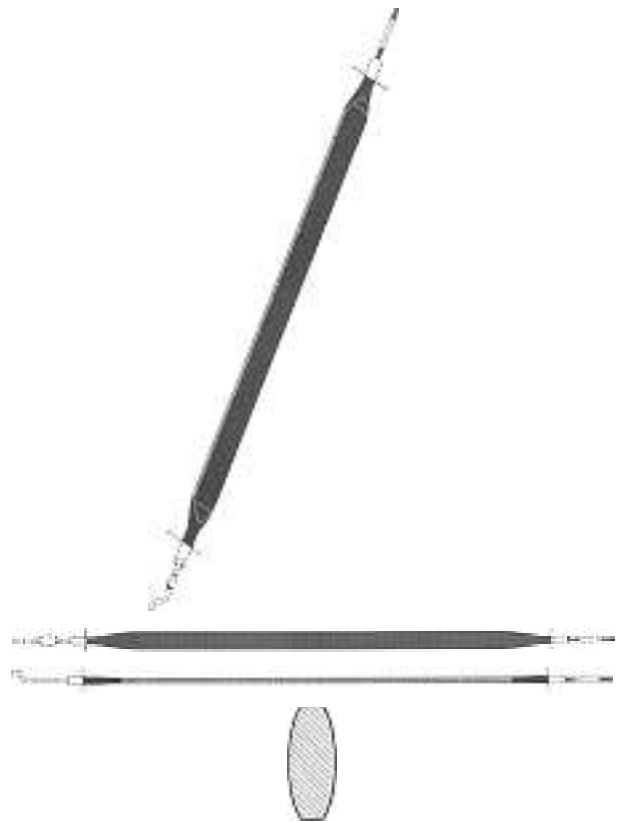

MB 51942/2

Cl. 13-03 **130 782** 01.06.2004  
 1 design – capteur de courant électrique  
 Déposant: Liaisons Electroniques-Mécaniques LEM S.A., 8, chemin des Aulx, 1228 Plan-les-Ouates  
 Designer: Pascal Morel, Saint Pierre en Faucigny  
 Mandataire: William Blanc & Cie, Conseils en Propriété Industrielle S.A., 1220 Les Avanchets/Genève

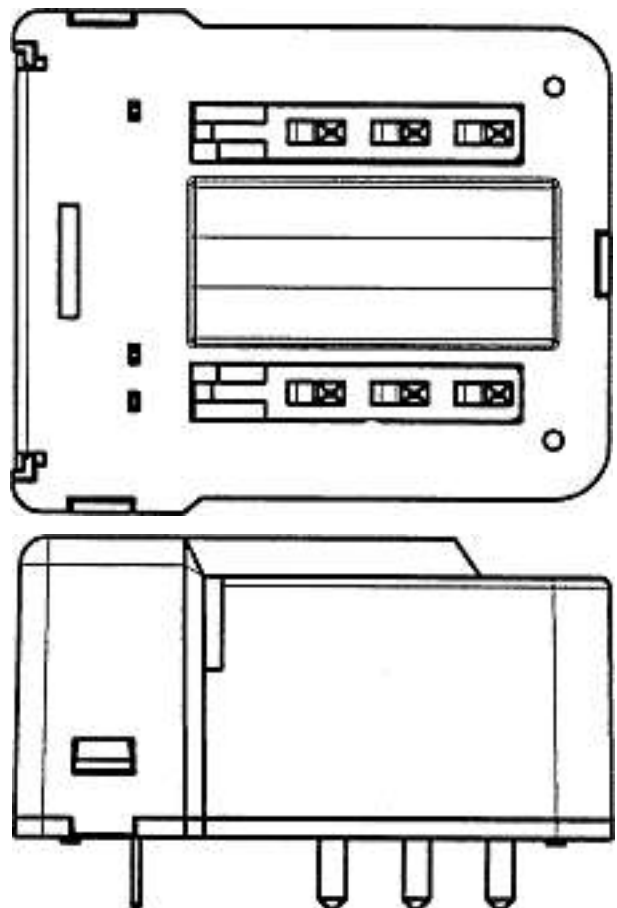

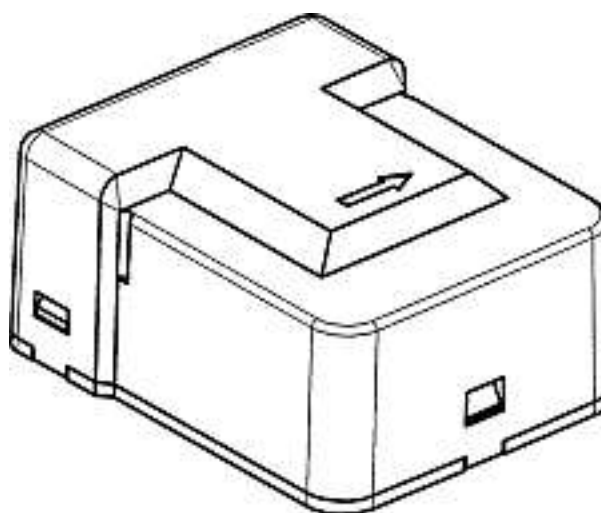
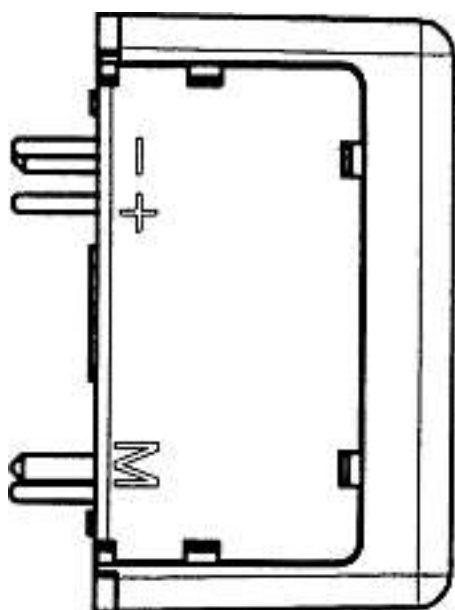
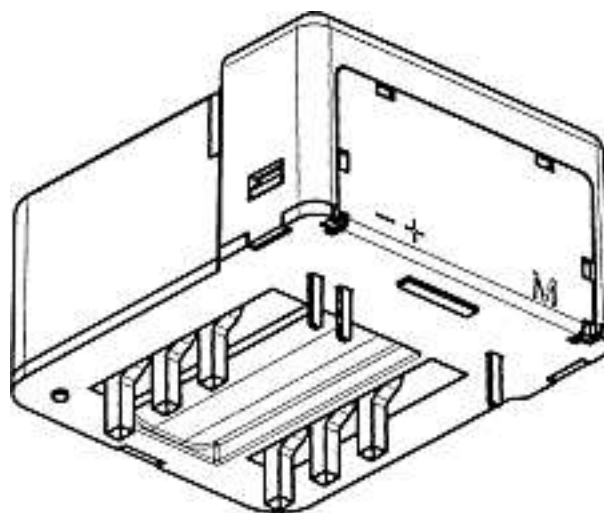
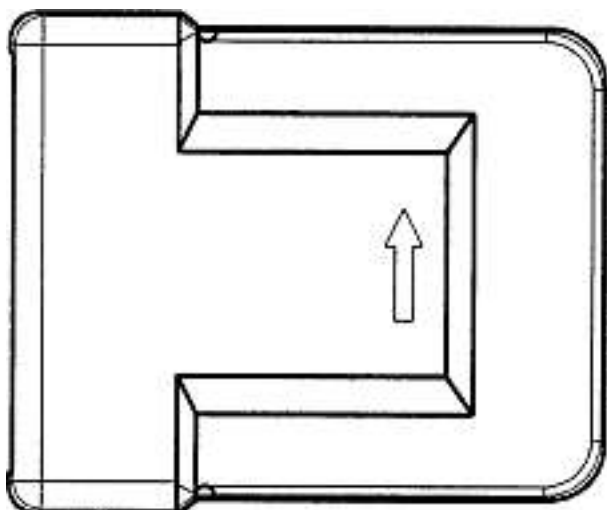
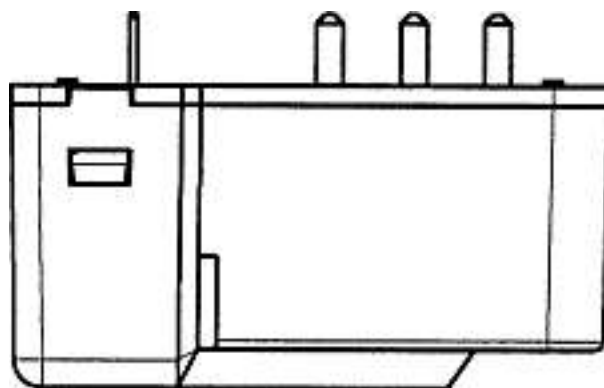
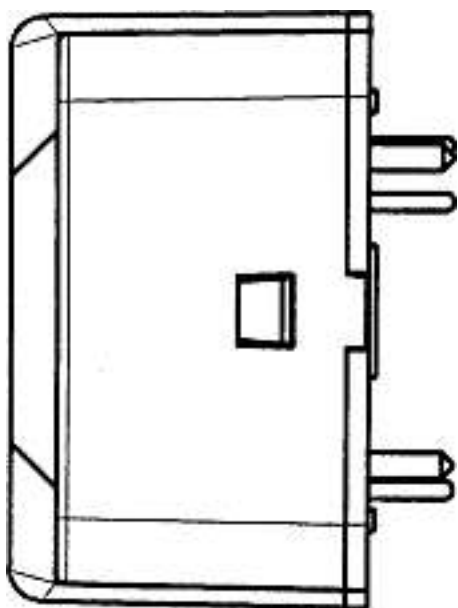

D-15039 CH

Cl. 15-05 130 783 01.06.2004  
1 Design – Staubsauger  
Hinterleger: BSH Bosch und Siemens Hausgeräte GmbH,  
Carl-Wery-Strasse 34, München, DE  
Designer: Jörg Schröter, Gröbenzell  
Vertreter: Isler & Pedrazzini AG, 8023 Zürich  
Priorität: EM, 05.12.2003



M12907



Cl. 20-02 130 784 15.05.2004  
 1 Design – Zeitungsständer  
 Hinterleger: Rolf Zweifel, chemin de Fontannaz 1,  
 1004 Lausanne

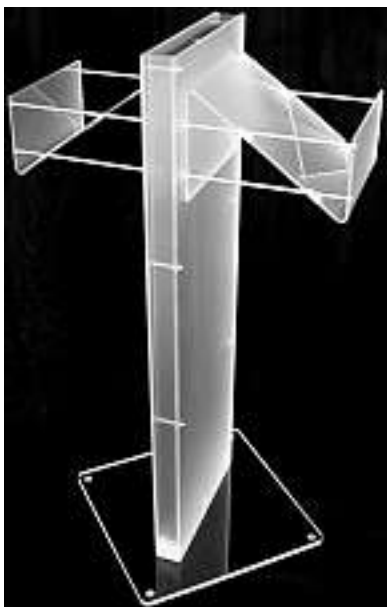

1/2004

Cl. 20-02 130 785 17.05.2004  
 1 Design – Verkaufsständer  
 Hinterleger: Bruno Messerli, Hauptstrasse 106, Brittern,  
 4587 Aetingen  
 Vertreter: Fuhrer Marbach & Partner, 3007 Bern



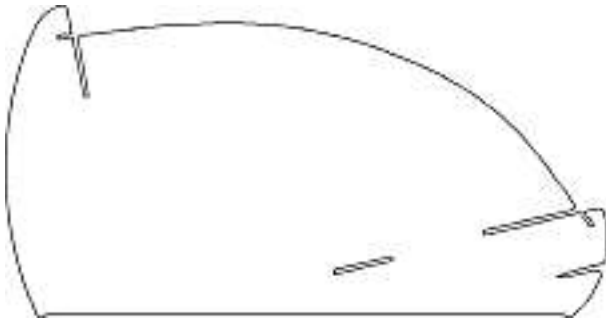

650674/681-CH-MOD01

Cl. 20-03 **130 787** 21.05.2004  
 1 design – dispositif d'affichage électronique  
 Déposant: eSpeed, Inc., 135 E 57th Street, New York, NY, US  
 Designer: Lee M. Amaitis, London; James C. Johnson, London; Joseph C. Noviello, New York; Nigel J. Renton, London; Michael Sweeting, Aldershot  
 Mandataire: Novagraaf International SA, 1220 Les Avanchets  
 Priorité: US, 21.11.2003

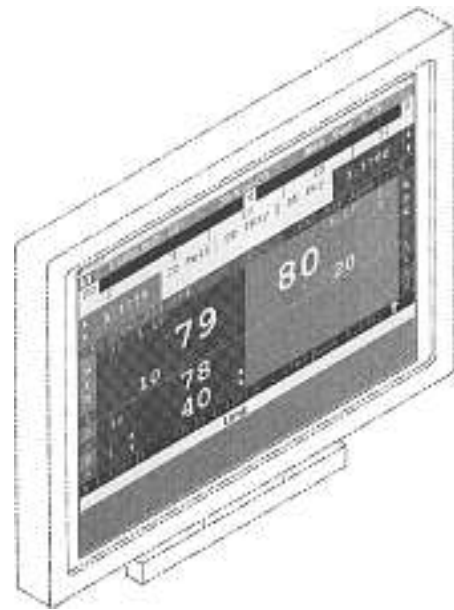
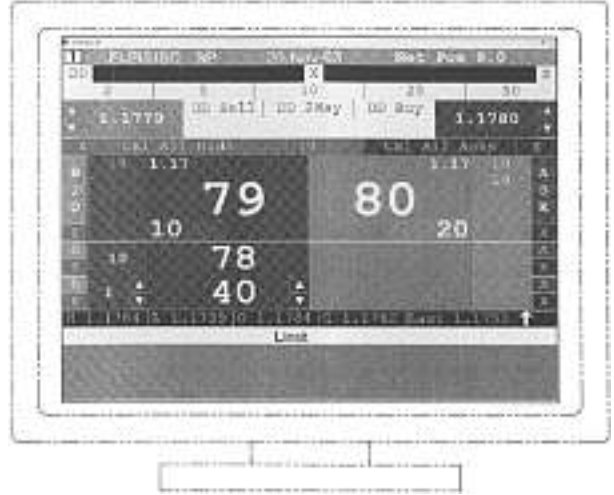

1

Cl. 20-02 **130 786** 19.05.2004  
 1 Design – Farbreferenzkarte  
 Hinterleger: Martin Schermesser, Oberwilerstrasse 88, 4054 Basel, ; Michael Walter, Obere Gasse 17, 7000 Chur  
 Vertreter: Martin Schermesser, 4054 Basel

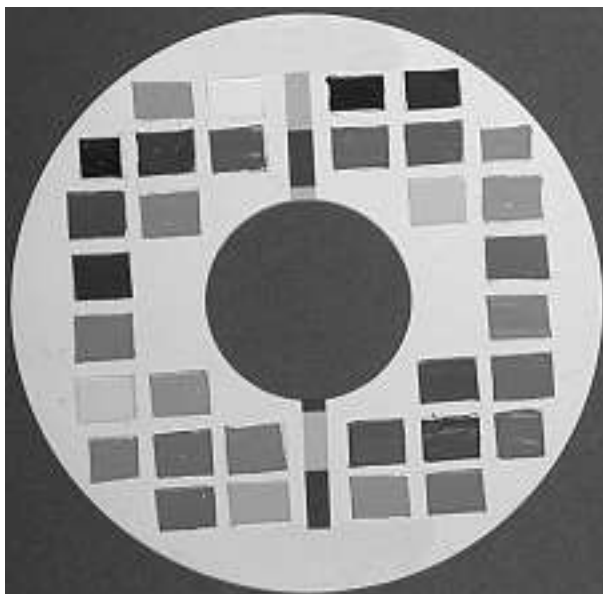
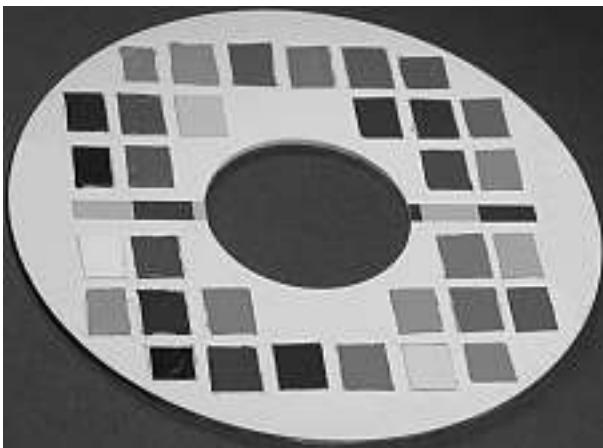

1

Cl. 21-02 **130 788** 04.06.2004  
 1 Design – Rahmen für Sportgerät  
 Hinterleger: bikeboard GmbH, Seidengasse 17, 8706 Meilen  
 Designer: Walter Egli, Siggenthal Station





53244/2004

Cl. 23-02                      **130 789**                      22.06.2004  
 2 Design – Lavabos  
 Hinterleger: Keramik Holding AG Laufen, Wahlenstrasse 46,  
 4242 Laufen  
 Designer: Peter Wirz, Luzern  
 Vertreter: A. Braun, Braun, Héritier, Eschmann AG,  
 Patentanwälte, 4051 Basel



1

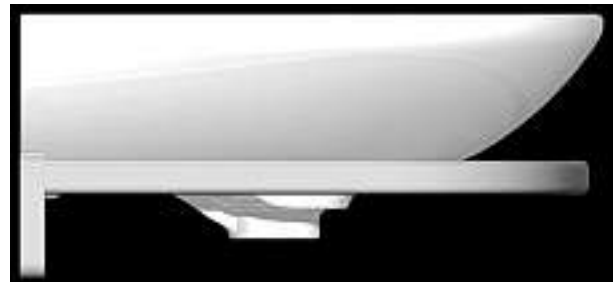

2

Cl. 24-02 130 790 28.05.2004  
 1 Design – Teststreifen  
 Hinterleger: Inverness Medical Limited, Beechwood Park North, Inverness IV2 3ED, GB  
 Designer: Linsey Whyte, Scorguie; Erica Mary Beck, Nairn; Emma-Louise Robertson, Culloden; Darren Iain Mitchell, Inverness  
 Vertreter: E. Blum & Co., 8044 Zürich  
 Priorität: US, 03.12.2003

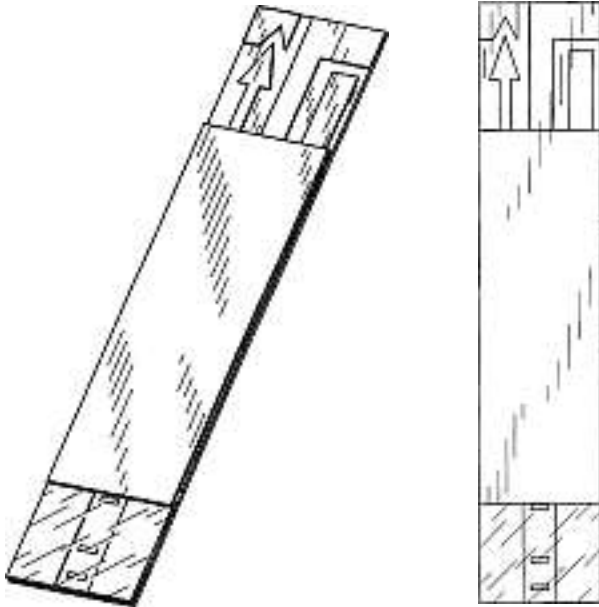

A-2004/1022

Cl. 24-02 130 791 28.05.2004  
 1 Design – Messinstrument für Analyten  
 Hinterleger: Inverness Medical Limited, Beechwood Park North, Inverness IV2 3ED, GB  
 Designer: Steven Alexander Syme, Inverness; Louis Boyd, Dunfermline; Gillian Margaret Galloway, Dingwall; Lou Cabana, Farr; Bryan Keith Windus-Smith, Moray  
 Vertreter: E. Blum & Co., 8044 Zürich  
 Priorität: US, 03.12.2003

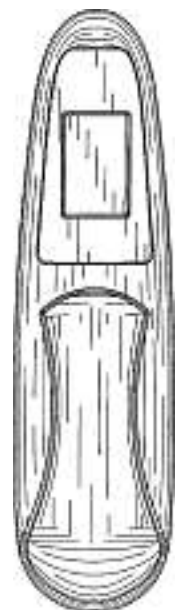
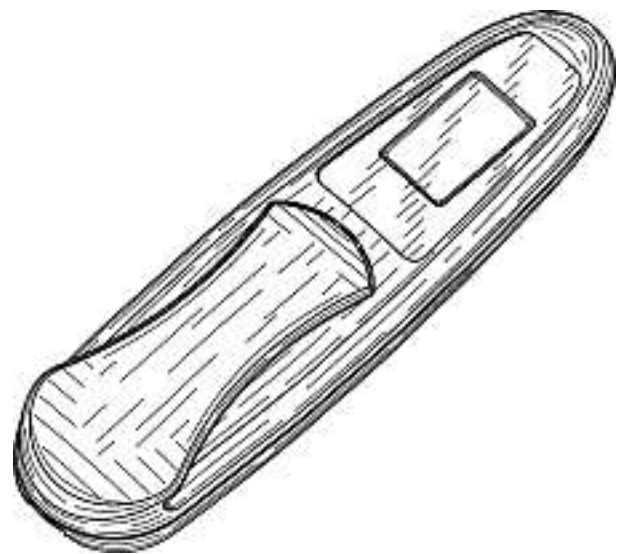

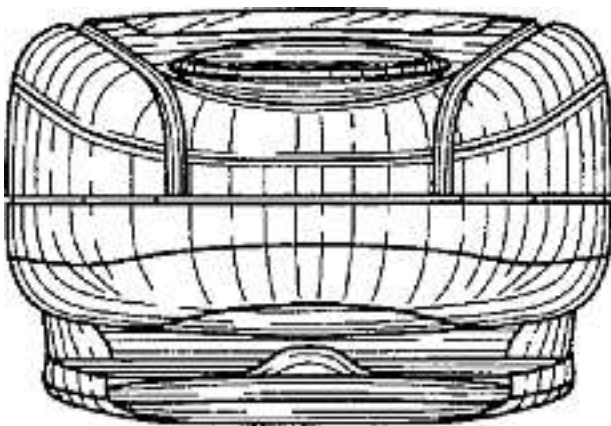
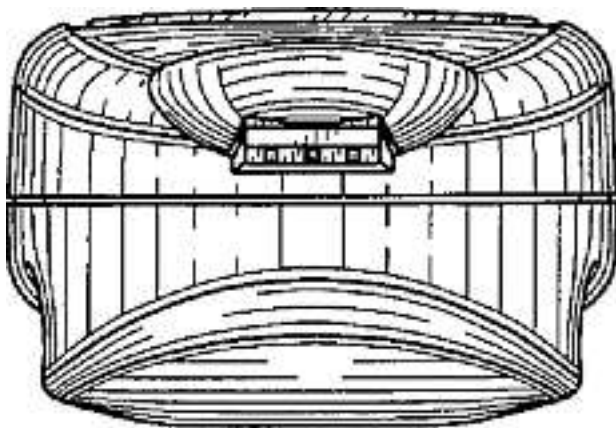

A-2004/1023

Cl. 25-02                      **130 792**                      24.05.2004  
 6 Design – Raffstore-Lamelle  
 Hinterleger: Franz Kraler, Abfaltersbach 125, Abfaltersbach, AT  
 Vertreter: Isler & Pedrazzini AG, 8023 Zürich  
 Priorität: EM, 15.12.2003; EM, 31.03.2004



1

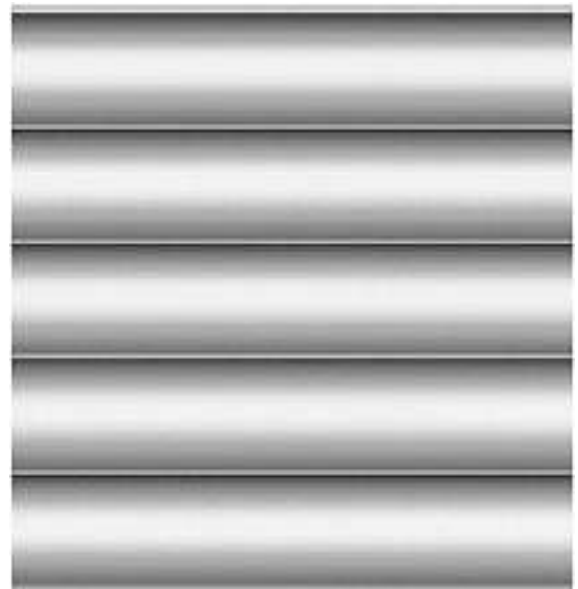

2

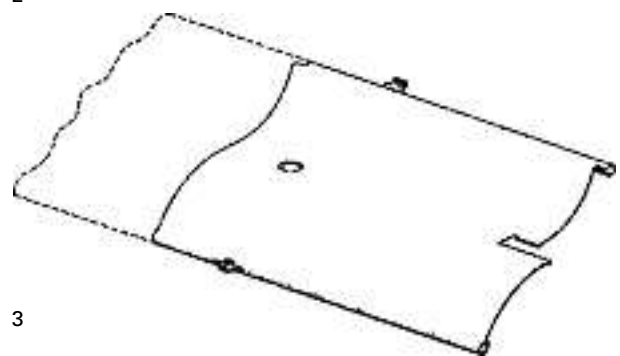

3



4



5



6

Cl. 25-02 **130 793** 25.05.2004  
 1 Design – Sonnensegel/Sonnendach  
 Hinterleger: Rico Gabathuler, Loorenstrasse 19c,  
 8910 Affoltern am Albis; Walter Sticher, Birkenhof 1,  
 6405 Immensee  
 Vertreter: Rico Gabathuler, 8910 Affoltern am Albis

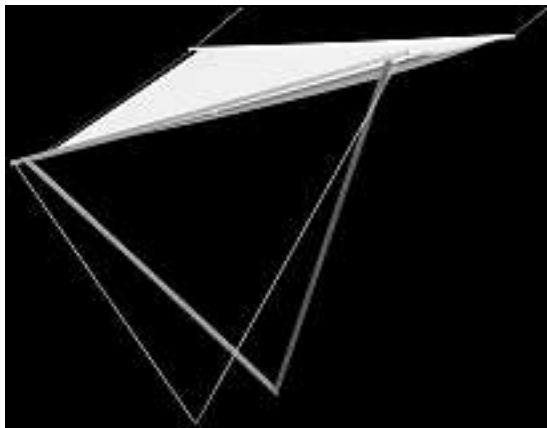

1

Cl. 25-03 **130 794** 26.05.2004  
 8 Design – Gebäude und Gebäudefassaden  
 Hinterleger: Hans Zwimpfer, Wettsteinallee 64, 4058 Basel  
 Vertreter: Industrieberatung Maier AG, 4450 Sissach

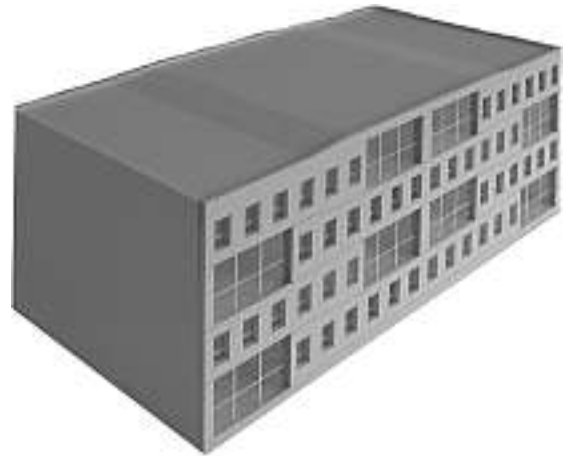

PU\_01-04

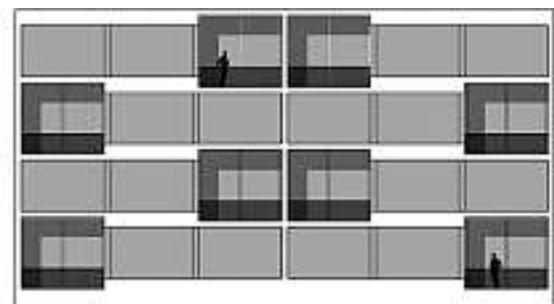

Variante 1



Variante 2



Variante 3



Variante 4

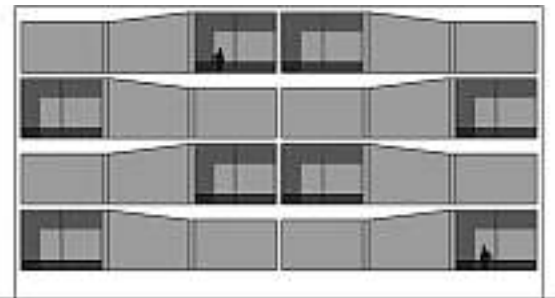

Variante 5

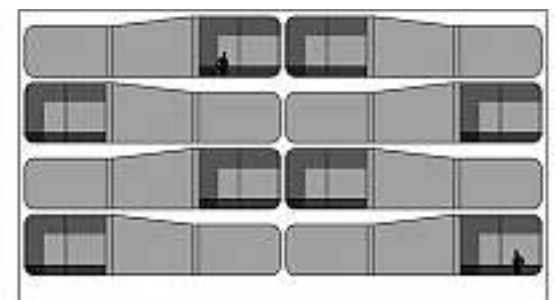

Variante 6

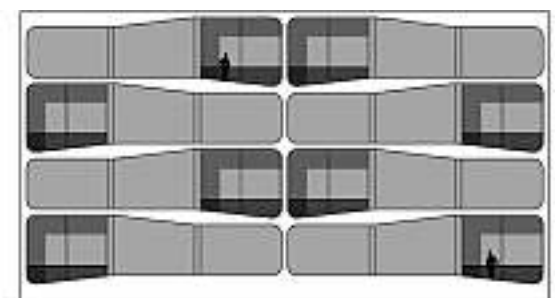

Variante 7

Cl. 26-05 **130 795** 28.05.2004  
 2 Design – Leuchtenkopf, Leuchte  
 Hinterleger: Lighting Innovation Center AG, Mühlental-  
 strasse 28, 8200 Schaffhausen  
 Designer: Ralph Wichmann, Schaffhausen; Jürgen Nevoigt,  
 Schwenningen  
 Vertreter: DTS Zürich, 8029 Zürich



StraightM-2-Strahl

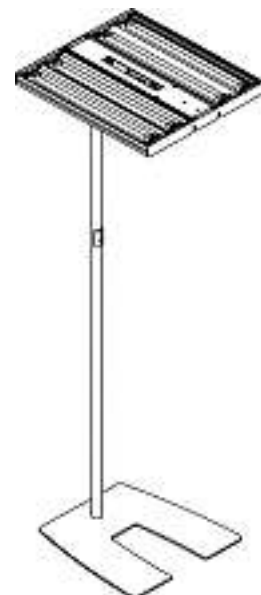

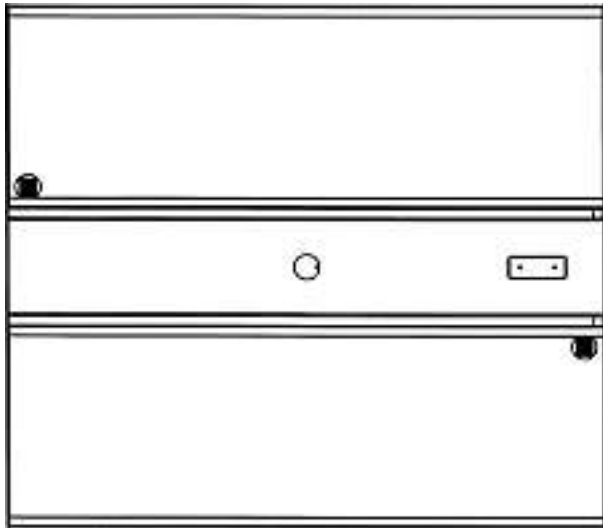

StraightM-4-Strahl

Cl. 26-05                      130 796                      05.06.2004  
4 Design – Lampen  
Hinterleger: Belux AG, Bremgarterstrasse 109, 5610 Wohlen AG  
Designer: Frank O. Gehry, Los Angeles  
Vertreter: AXON Patent GmbH, 4147 Aesch



2



3



1







4

Cl. 26-05                      130 797                      05.06.2004  
7 Design – Lampen  
Hinterleger: Belux AG, Bremgarterstrasse 109,  
5610 Wohlen AG  
Designer: Erwan Bouroullec, Saint-Denis; Ronan Bouroullec,  
Saint-Denis  
Vertreter: AXON Patent GmbH, 4147 Aesch



1



2



3



4



5



6

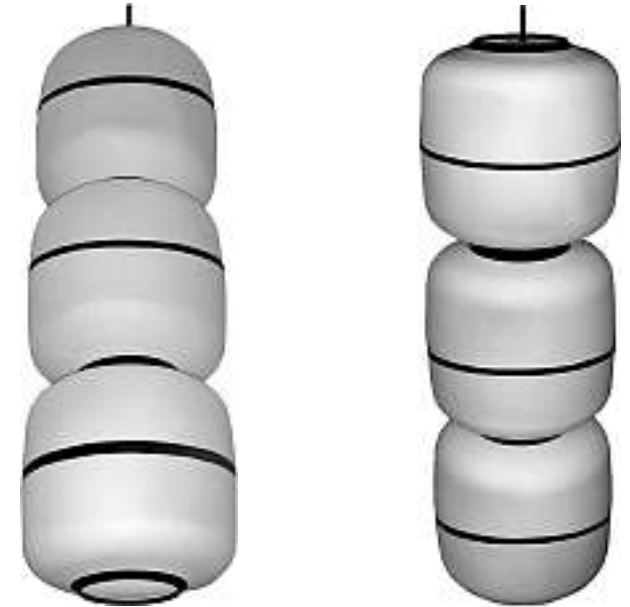

7

Cl. 30-02 **130 798** 07.06.2004  
 2 design – aquarium  
 Déposant: Michel Durand, Avenue de la Condémine, 40,  
 1814 La Tour-de-Peilz  
 ref01 (siehe Farbteil Heftmitte)  
 ref02 (siehe Farbteil Heftmitte)

**Verlängerungen**

**Prolongations**

**Prolongazioni**

117 558 Cl. 06-03 1 Design



1

117 617 Cl. 21-01 5 Design

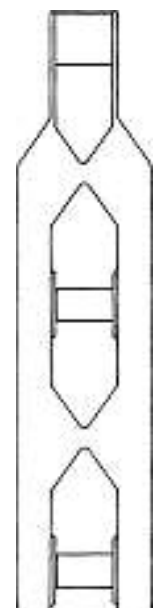
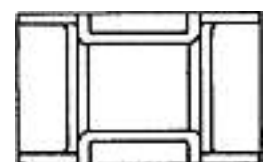
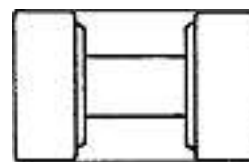
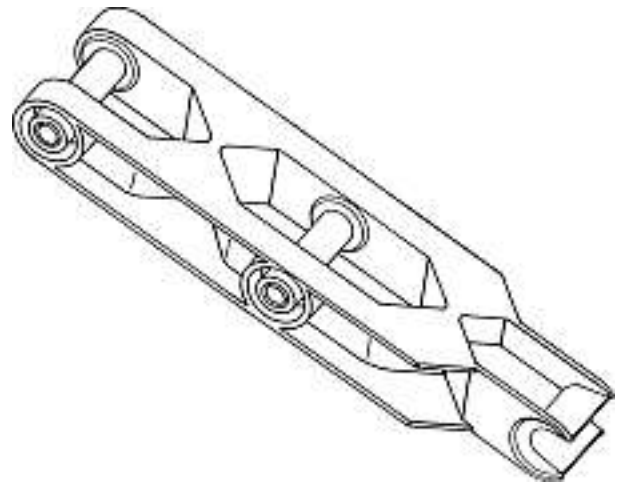
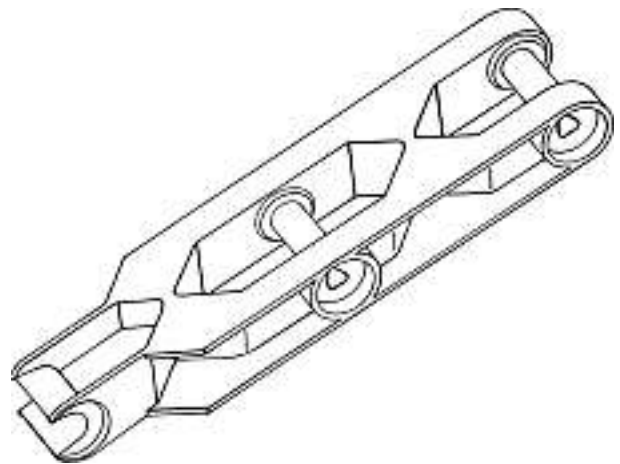

1

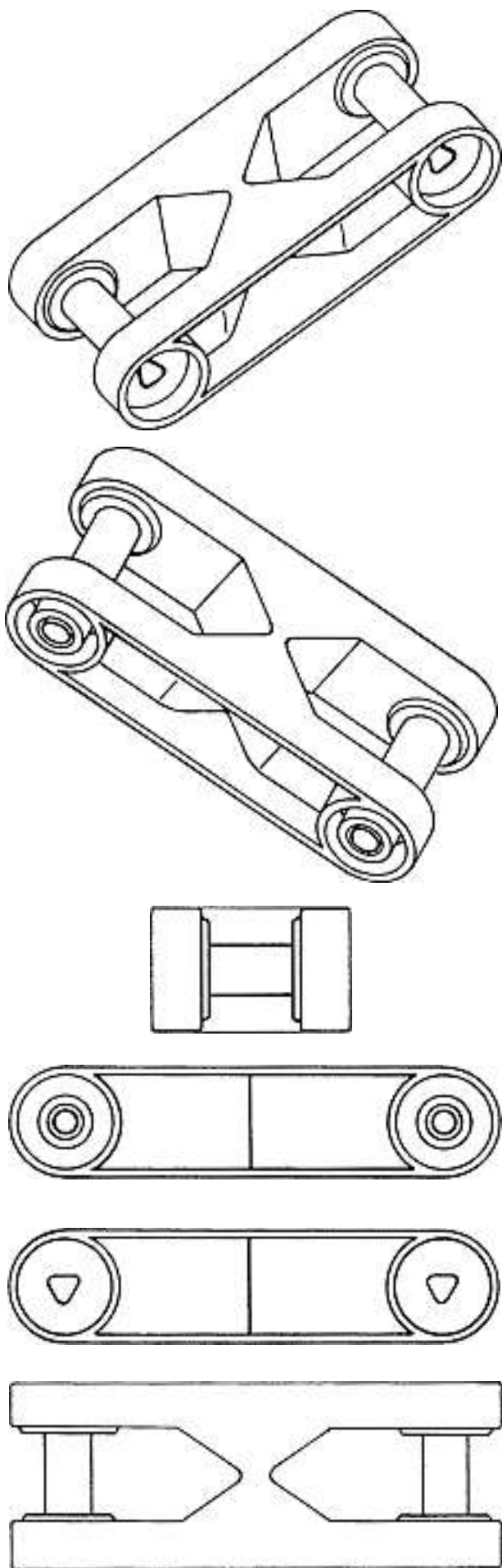

2

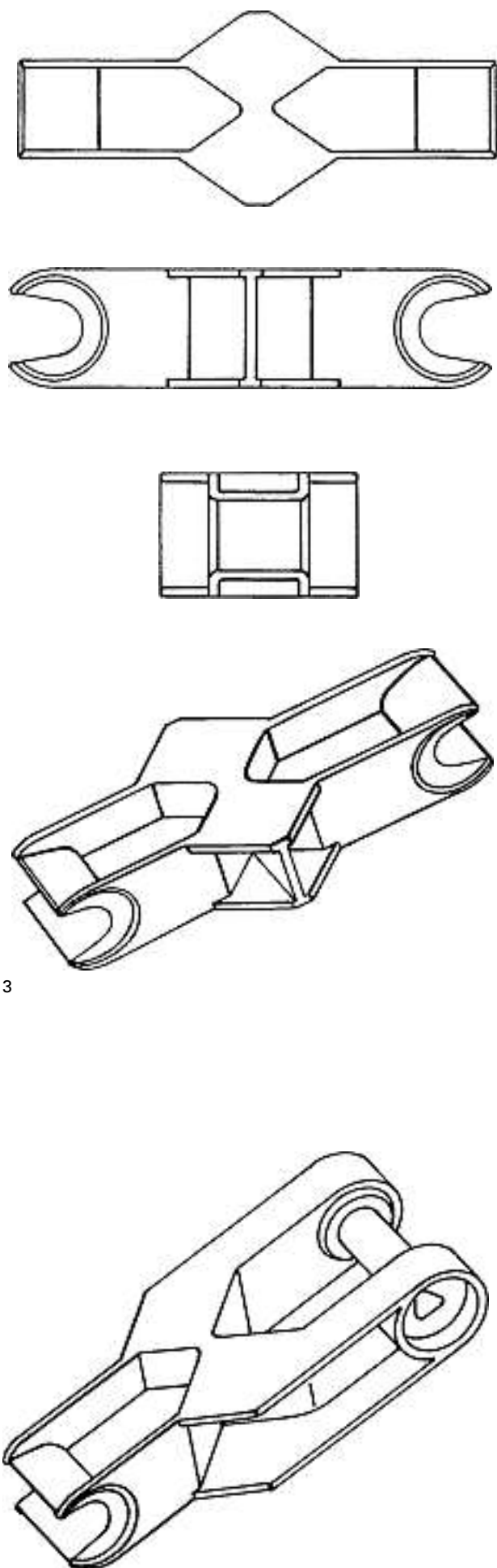

3

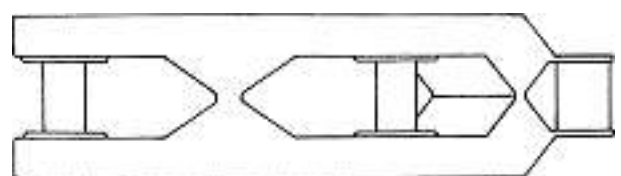
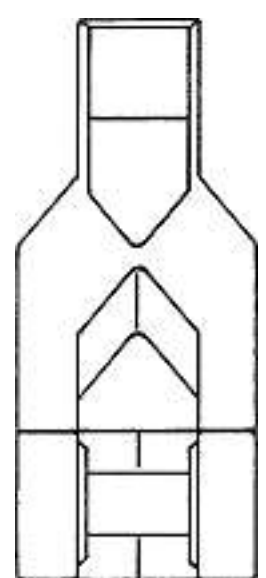
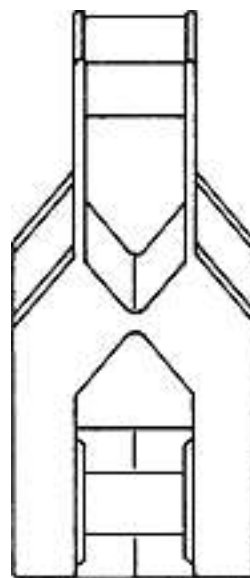
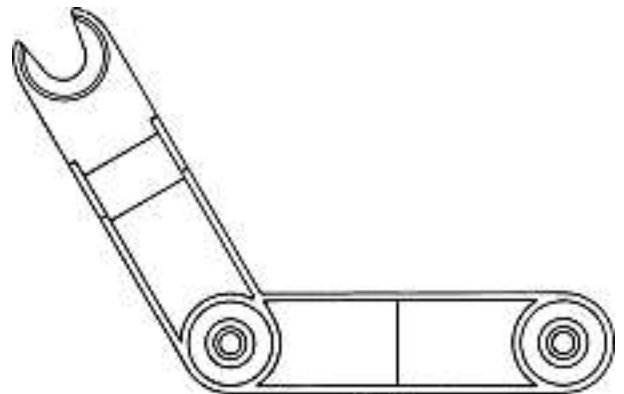
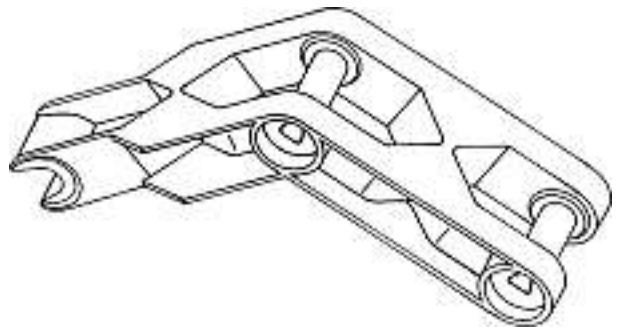
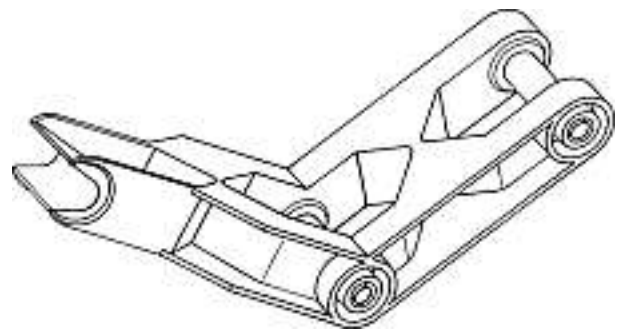
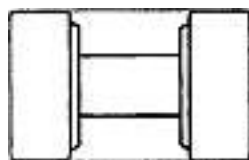
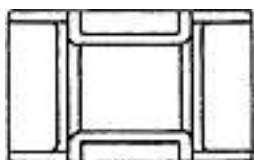
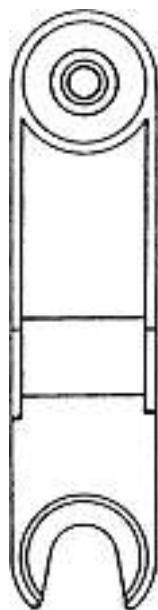
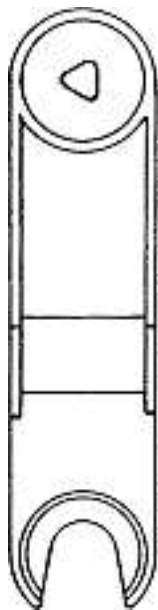
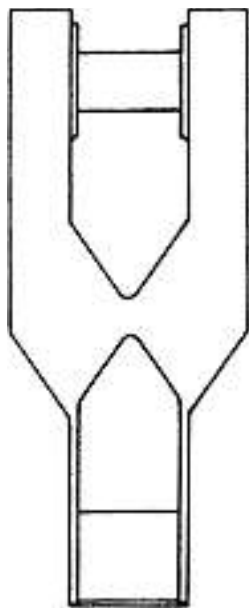
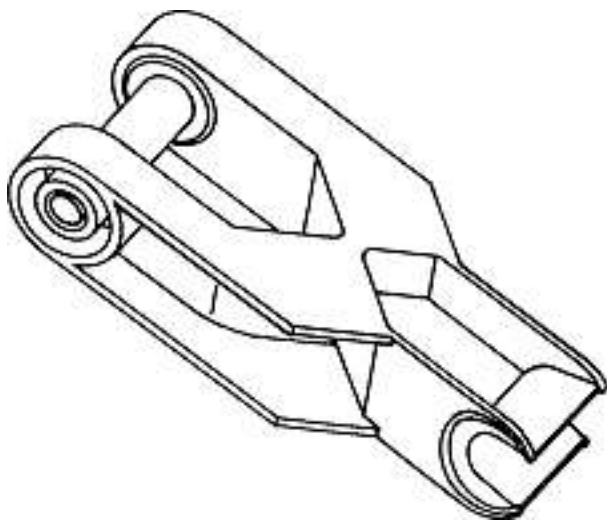

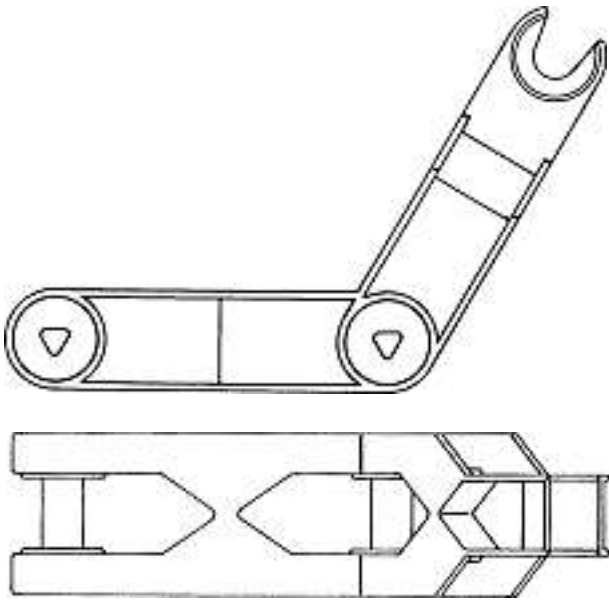

5

117 671 Cl. 06-03 1 design

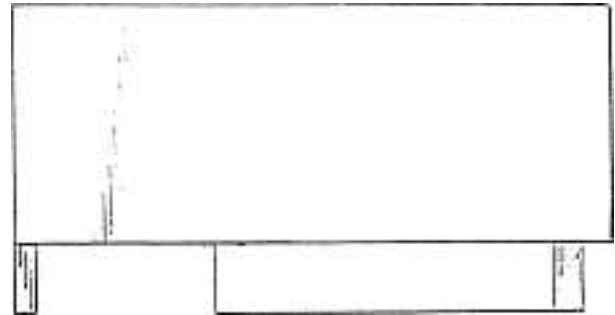
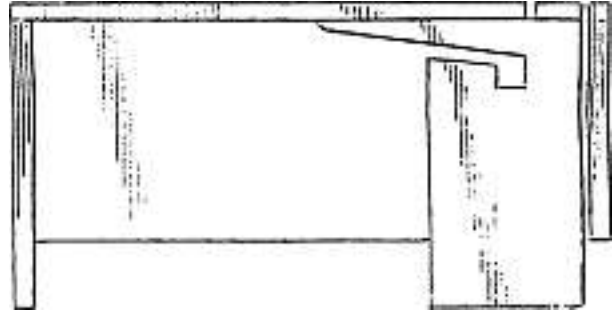
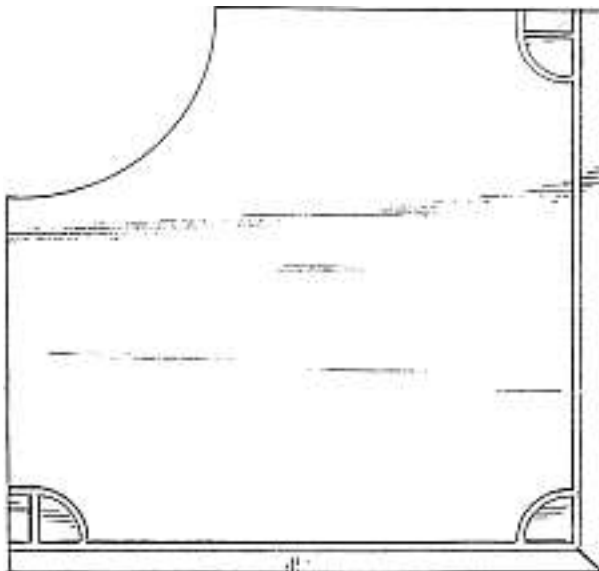
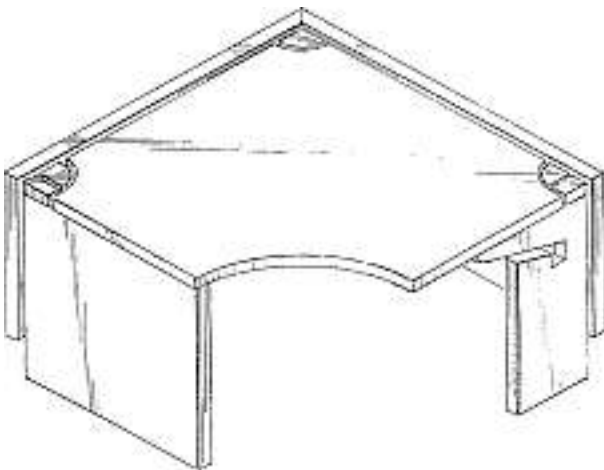

1

121 422	Cl.	10-07	1 design
121 495	Cl.	06-04	1 Design
121 500	Cl.	07-04	1 Design
121 862	Cl.	23-04	1 Design
126 189	Cl.	09-09	1 Design
126 190	Cl.	09-09	1 Design
126 198	Cl.	13-03	29 Design
126 208	Cl.	23-02	1 Design
126 237	Cl.	11-01	1 design
126 354	Cl.	12-11	1 design
126 387	Cl.	07-01	2 Design
126 397	Cl.	21-01	1 design
126 418	Cl.	10-06	1 design
126 420	Cl.	11-02	1 Design
126 471	Cl.	21-01	1 design
126 499	Cl.	11-04	1 Design
126 645	Cl.	13-03	3 design

**Mutationen****Modifications****Modificazioni****121 862**

Vertreter Firmaänderung

Vertreter: Fuhrer Marbach &amp; Partner, 3007 Bern

**128 650**

Transmission

Déposant: Vincent Perego, 7A, av. Bella-Vista, 1234 Vessy

**129 629**

Trasmissione

Depositante: Biomedical Industries Ltd, 3rd Floor, Geneva Place, Waterfront Drive, Tortola, VG

Mandatario: Fiammenghi-Fiammenghi, 6900 Lugano

**Löschungen****Radiations****Radiazioni**

117 122	Cl.	18-99	1 Design
117 148	Cl.	10-02	1 Design
117 149	Cl.	10-02	1 Design
117 191	Cl.	14-02	1 Design
121 036	Cl.	08-06	1 Design
121 050	Cl.	19-08	1 Design
125 626	Cl.	02-07	1 Design
125 629	Cl.	06-04	53 Design
125 665	Cl.	05-05	1 Design
125 666	Cl.	06-04	25 Design
125 668	Cl.	25-03	3 Design
125 672	Cl.	09-03	1 Design
125 673	Cl.	10-02	6 design
125 674	Cl.	10-07	1 Design
125 676	Cl.	11-01	3 Design
125 677	Cl.	11-02	5 Design
125 678	Cl.	13-03	10 Design
125 681	Cl.	19-08	12 Design
125 682	Cl.	19-08	1 Design
125 683	Cl.	19-08	1 Design
125 685	Cl.	21-01	1 Design
125 687	Cl.	21-03	2 design
125 689	Cl.	23-04	1 design
125 699	Cl.	03-01	1 Design
125 703	Cl.	06-03	3 Design
125 729	Cl.	14-03	1 Design
125 862	Cl.	20-02	1 Design
125 863	Cl.	20-02	1 Design
125 865	Cl.	23-04	1 design

Cl. 06-01

130 758

14.04.2004



1



2



3



4



5



6



Cl. 09-01

130 768

08.06.2004



FL 54956

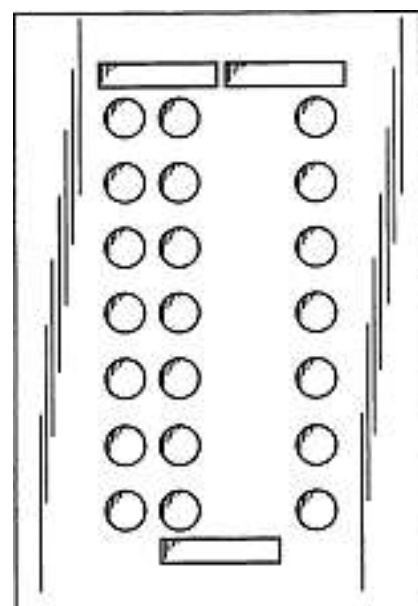
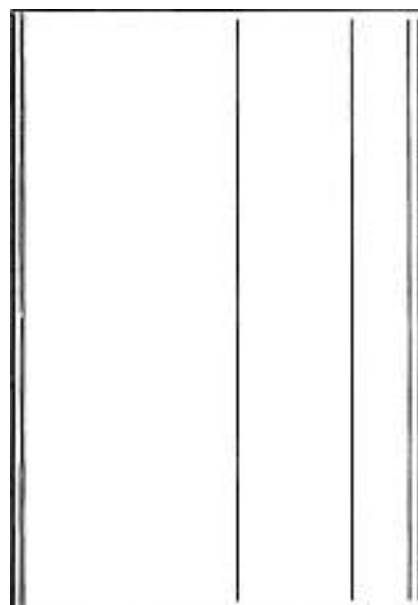

Cl. 09-05

130 770

13.05.2004

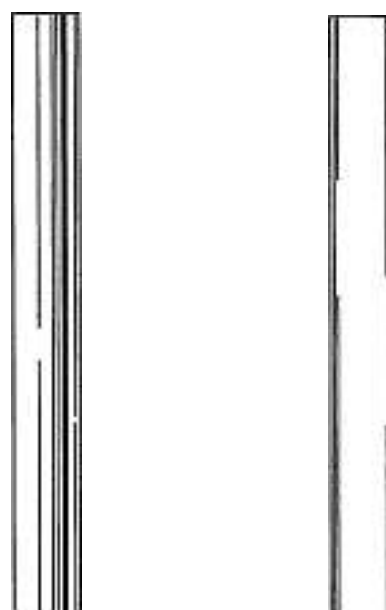
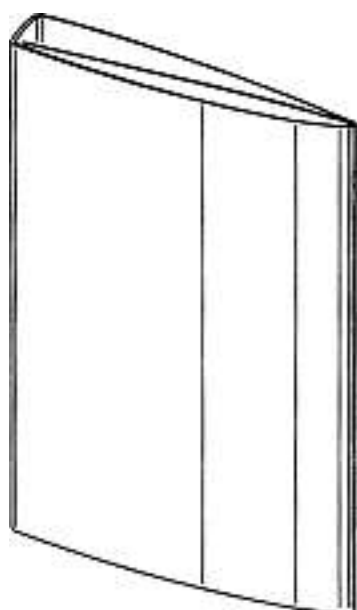

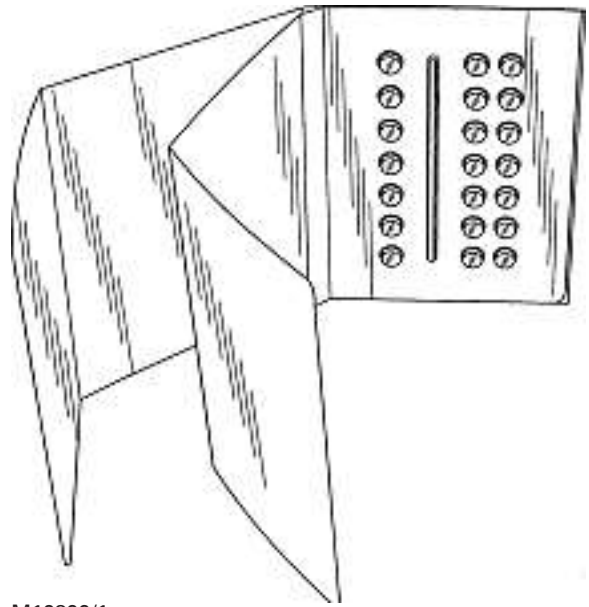
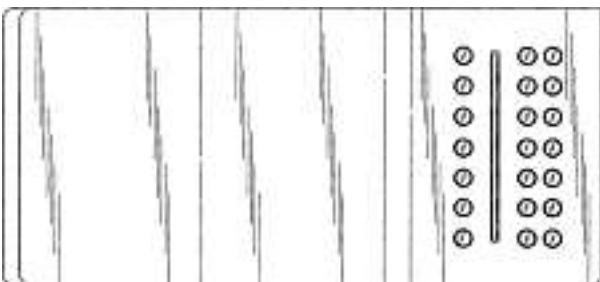
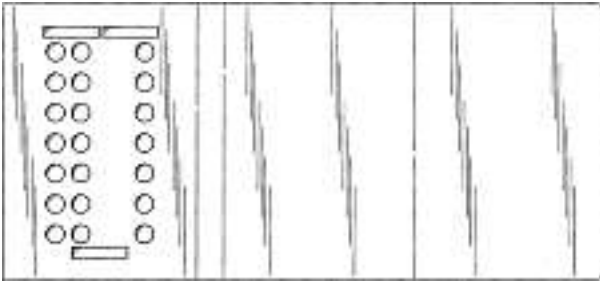
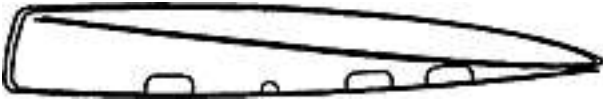

M12899/1

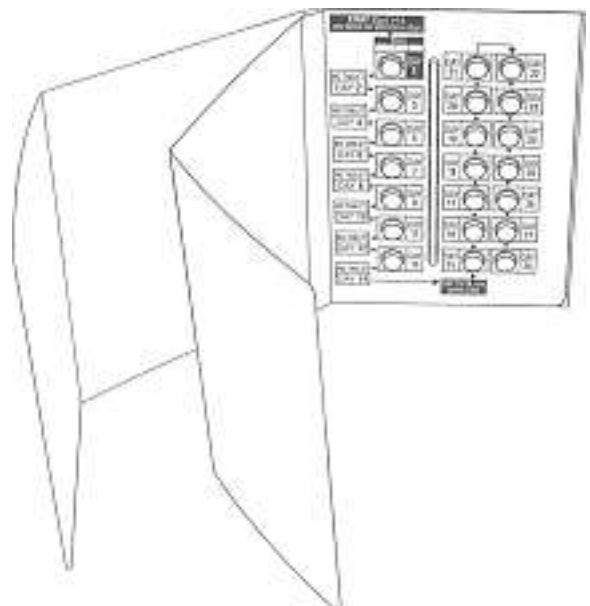



M12899/2



M12899/3

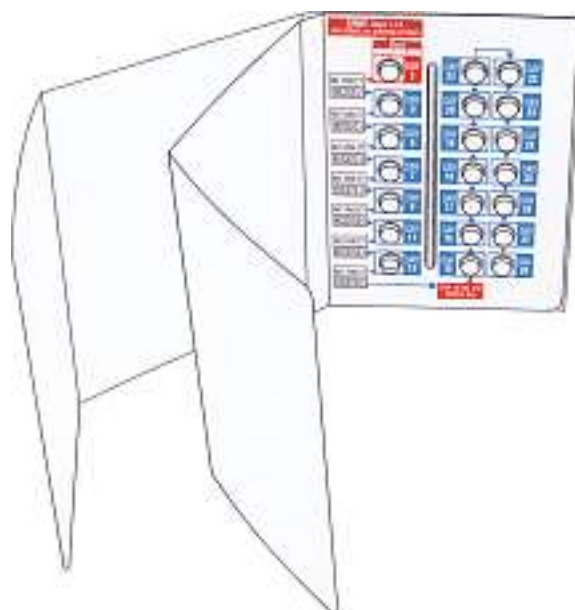
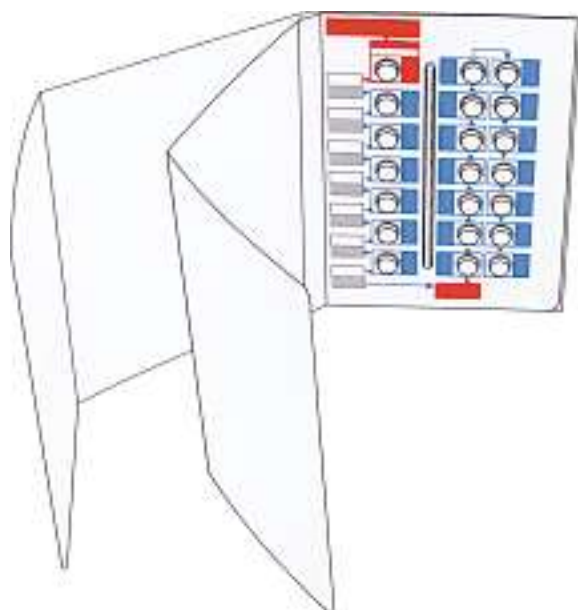
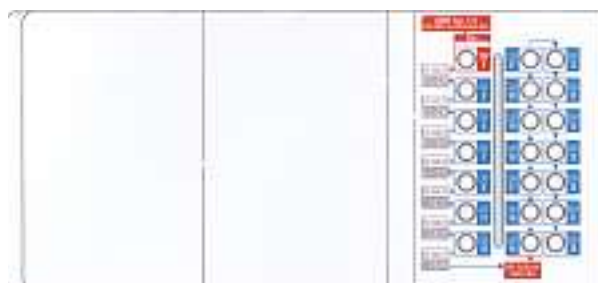



M12899/4

Cl. 09-09

130 771

07.05.2004



D300036



Cl. 10-07

130 774

18.03.2004



Cl. 30-02

130 798

07.06.2004



ref01



ref02