

Nationale Hinterlegungen

In der folgenden Liste werden die beim Eidgenössischen Institut für Geistiges Eigentum hinterlegten Designs publiziert. Dabei sind der Reihe nach angegeben:

- internationale Klassenangaben
- Hinterlegungsnummer
- Hinterlegungsdatum
- Allenfalls Aufschub der Veröffentlichung
- Anzahl der hinterlegten Designs
- Bezeichnung
- Name und Wohnsitz des Hinterlegers oder der Hinterlegerin
- gegebenenfalls Name und Wohnsitz des Designers oder der Designerin
- Name und Geschäftssitz des allfälligen Vertreters oder der Vertreterin
- gegebenenfalls Prioritätsangaben
- gegebenenfalls Beschreibungstext
- Ordnungsnummer
- Reproduktion des Designs

Internationale Hinterlegungen

Die bei der Weltorganisation für geistiges Eigentum in Genf hinterlegten Muster und Modelle mit Benennung Schweiz geniessen den gleichen Schutz wie national hinterlegte Designs. Sie werden jeweils im Blatt «Bulletin des dessins et modèles internationaux» veröffentlicht. Dieses Publikationsorgan ist deshalb für eine vollständige Recherche unbedingt beizuziehen.

Topographien

Angaben über die vom Eidgenössischen Institut für Geistiges Eigentum eingetragenen Topographien von Halbleitererzeugnissen werden in folgender Anordnung aufgeführt:

- Eintragsnummer
- Anmeldedatum
- Bezeichnung
- Name und Wohnsitz des Anmelders oder der Anmelderin
- gegebenenfalls Name und Wohnsitz des Herstellers oder der Herstellerin
- Name und Geschäftssitz des oder der allfälligen Bevollmächtigten
- Datum und Ort einer allfälligen ersten geschäftlichen Verbreitung der Topographie

Dépôts nationaux

Les designs déposés à l'Institut Fédéral de la Propriété Intellectuelle sont publiés dans la liste qui suit. Les indications y relatives sont mentionnées dans cet ordre:

- indications des classes internationales
- numéro de dépôt
- date de dépôt
- le cas échéant, ajournement de la publication
- nombre des designs déposés
- désignation
- nom et domicile du/de la déposant/e
- le cas échéant, nom et domicile du/de la designer
- nom et domicile de l'éventuel/le mandataire
- le cas échéant, indication de priorité
- le cas échéant, description du design
- numéro attribué à chaque design
- reproduction du design

Dépôts internationaux

Les dessins et modèles déposés à l'Organisation Mondiale de la Propriété Intellectuelle à Genève qui désignent la Suisse jouissent de la même protection que les dépôts nationaux. Ils sont chaque fois publiés dans la feuille «Bulletin des dessins et modèles internationaux». Pour une recherche complète, il est indispensable de consulter ledit organe de publication.

Topographies

Les indications concernant les topographies des produits semi-conducteurs, enregistrées par l'Institut Fédéral de la Propriété Intellectuelle, sont énumérées dans l'ordre suivant:

- numéro d'enregistrement
- date de dépôt
- désignation
- nom et domicile du/de la déposant/e
- le cas échéant, nom et domicile du/de la producteur/trice
- nom et domicile de l'éventuel/le mandataire
- date et lieu d'une éventuelle première mise en circulation de la topographie

Depositi nazionali

Nella lista seguente vengono pubblicati i design depositati presso l'Istituto Federale della Proprietà Intellettuale. Sono menzionati nel seguente ordine:

- indicazioni delle classi internazionali
- numero di deposito
- data del deposito
- se del caso, indicazione che la pubblicazione è stata differita
- numero dei design depositati
- designazione
- nome e domicilio del depositante
- se del caso, nome e domicilio del designer
- nome e sede di un eventuale mandatarario
- se del caso, indicazioni di priorità
- se del caso, descrizione del design
- numero d'ordine
- riproduzione del design

Depositi internazionali

I disegni e modelli depositati presso l'Organizzazione Mondiale della Proprietà Intellettuale a Ginevra con denominazione Svizzera godono della medesima protezione del deposito nazionale. Essi vengono pubblicati ogni volta nel foglio «Bulletin des dessins et modèles internationaux». Quest'organo di pubblicazione è da consultare se si vuole effettuare una ricerca completa.

Topografie

Le indicazioni concernenti le topografie di prodotti a semiconduttori depositati presso l'Istituto Federale della Proprietà Intellettuale sono menzionate nell'ordine seguente:

- numero di registrazione
- data del deposito
- designazione
- nome e domicilio del/la richiedente
- se del caso, nome e domicilio del/la produttore/trice
- nome e sede di un eventuale mandatarario
- data e luogo di un'eventuale prima messa in circolazione della topografia

**Hinterlegungen
Dépôts
Deposit**

Cl. 26-05 **129 304** 11.01.2003
 1 Design – Leuchte
 Hinterleger: Werner Rauber, Alpenblickstrasse 75,
 8340 Hinwil
 Ende aufgeschobene Publikation

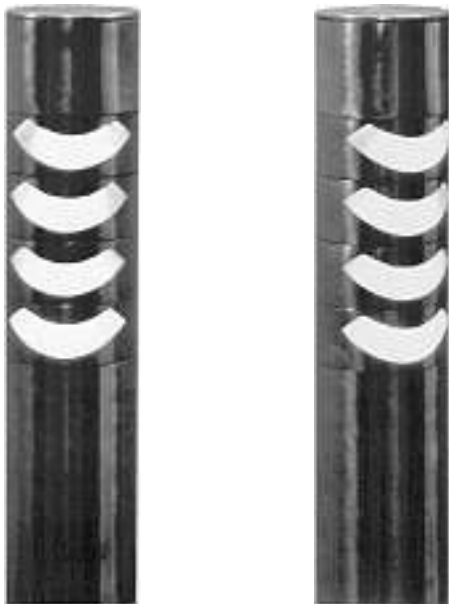

Luna 20

Cl. 23-01 **130 654** 18.05.2004
 8 Design – Armaturen
 Hinterleger: KWC AG, Hauptstrasse 57, 5726 Unterkulm
 Designer: Roland Gloor, Unterkulm; Massimo Luca, Thiene;
 Enrico Simone Boffi, Orsenigo; Michael Lammel, Aachen;
 Michael Zeisel, Aachen
 Vertreter: Patentanwälte, Schaad, Balass, Menzl & Partner AG,
 8034 Zürich
 Ende aufgeschobene Publikation

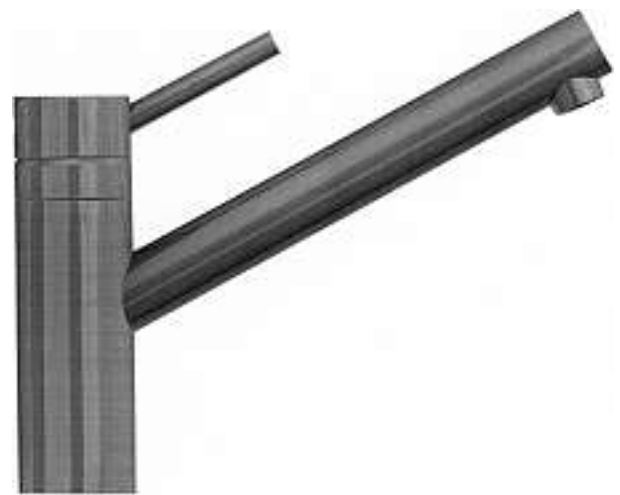

1

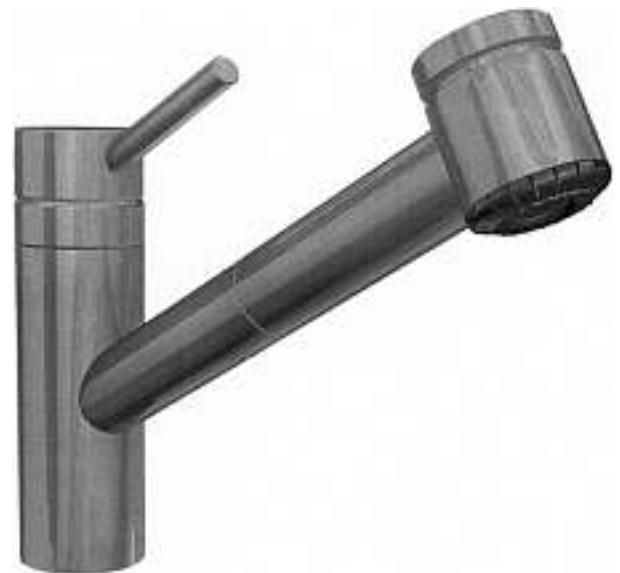



2



3





4



5





6



7





8

Cl. 03-01 131 820 24.05.2005
1 design – borsa
Depositante: Valentino S.p.A., Via Turati, 16/18, Milano, IT
Designer: Michele Norsa, Milano
Mandatario: Jacobacci & Partners S.A., 1207 Genève
Priorità: EM, 26.11.2004

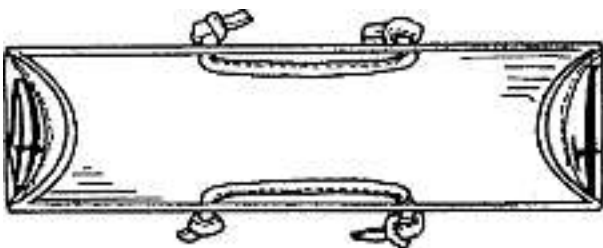

D-1983/05-CH

Cl. 06-01, 06-02, 06-03, 06-04 131 821 02.05.2005
19 Design – Tisch, Bänke, Hocker, Regale, Kommoden, Bett
Hinterleger: Dominique Jehle, Matthäusstrasse 10, 4057 Basel

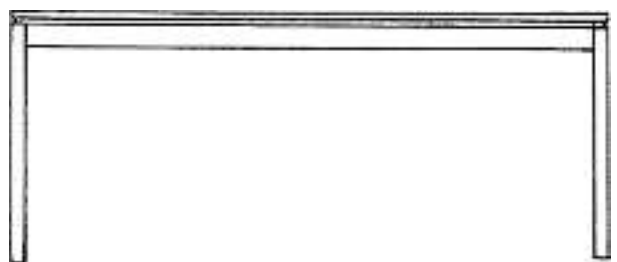
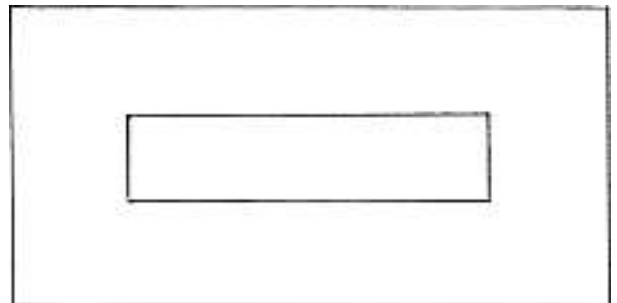

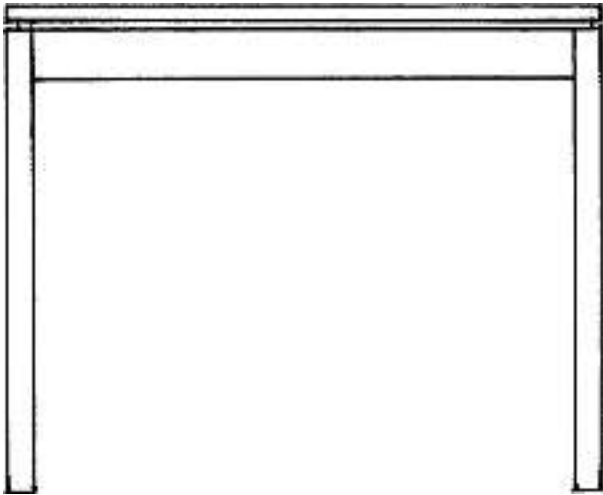

WohnArt 1

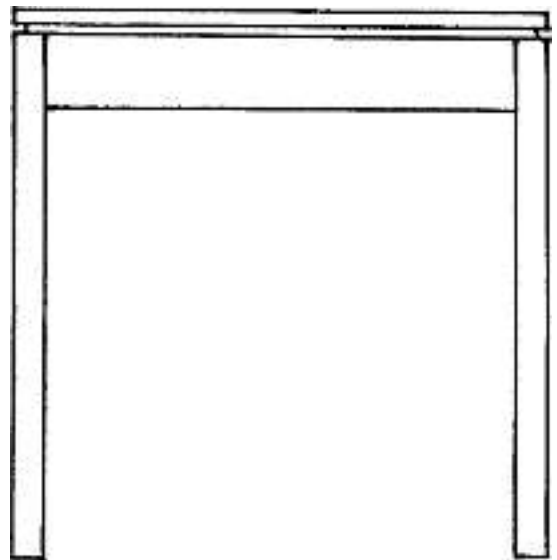

WohnArt 2

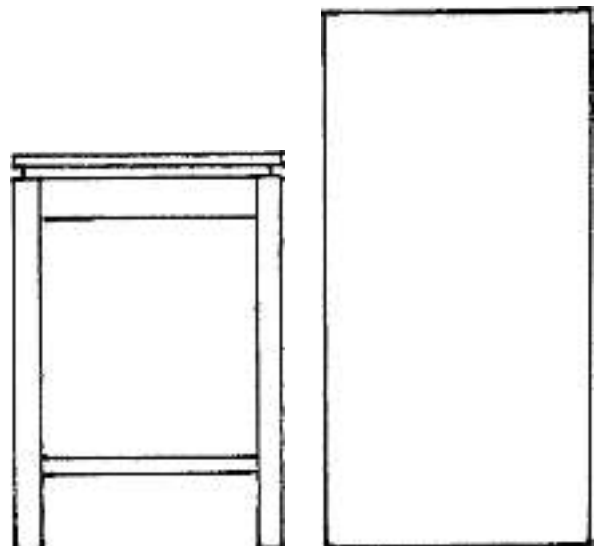
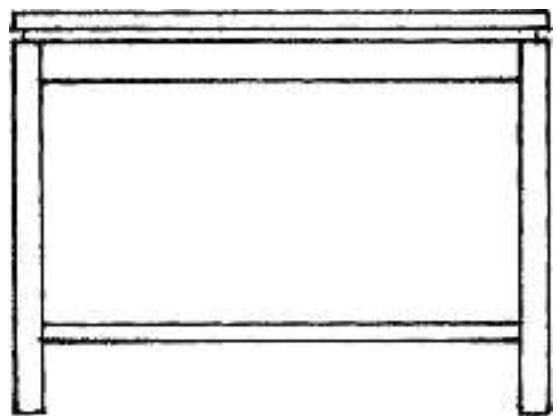
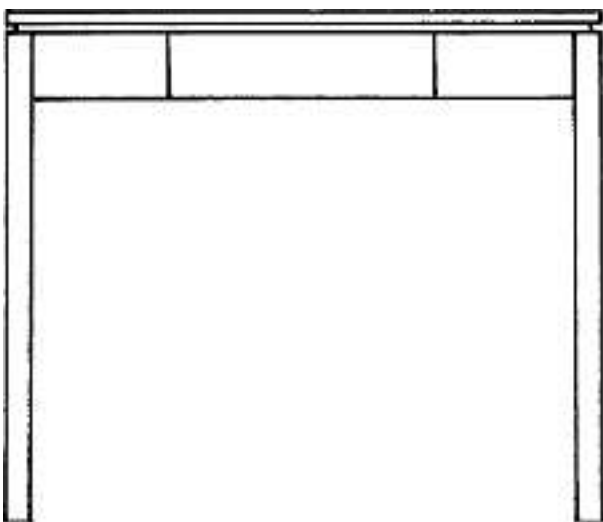
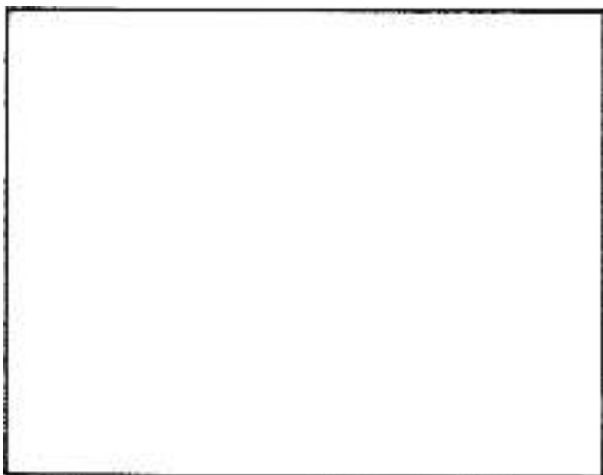

WohnArt 3

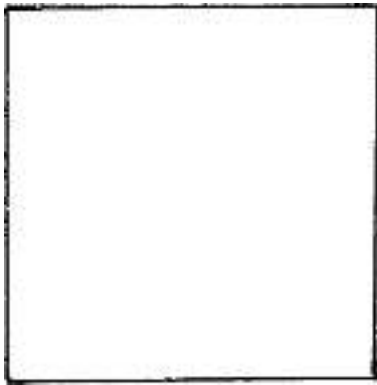

WohnArt 4a

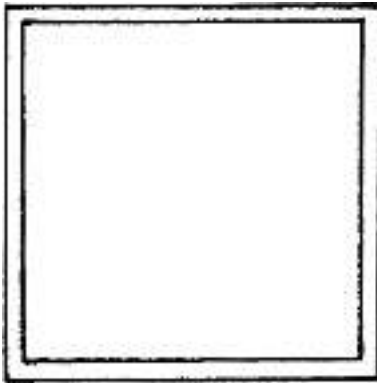

WohnArt 4b

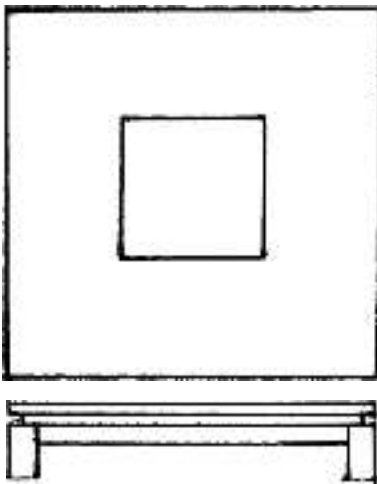

WohnArt 4c

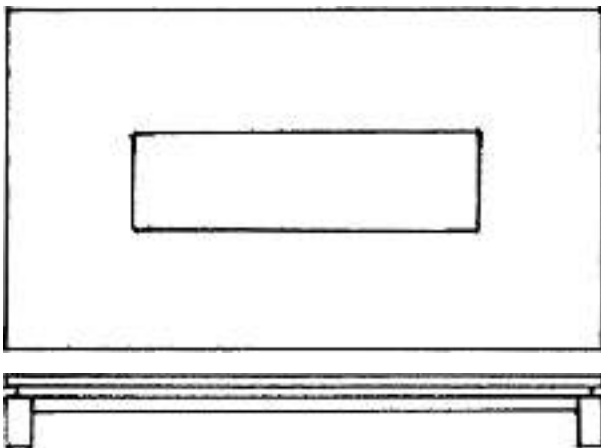

WohnArt 5

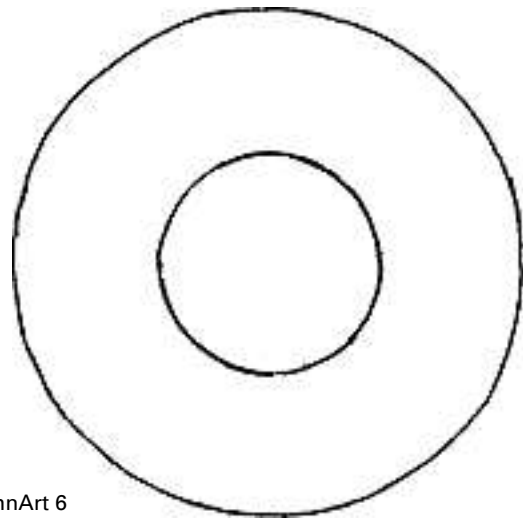
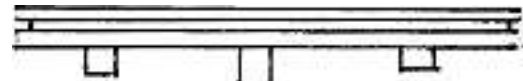

WohnArt 6

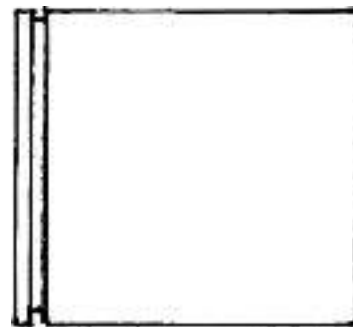
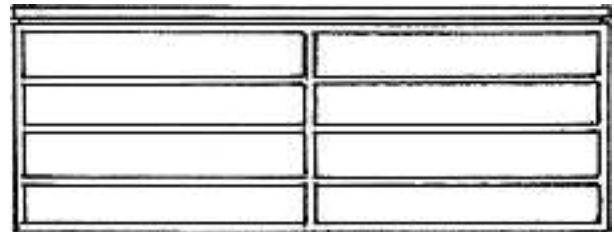
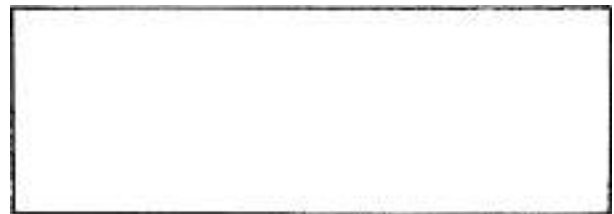

WohnArt 7

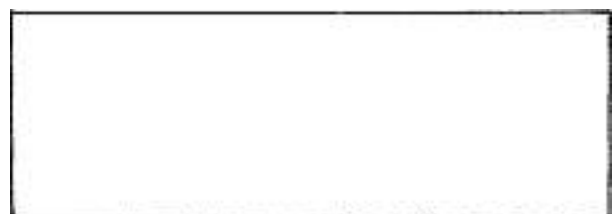

WohnArt 8

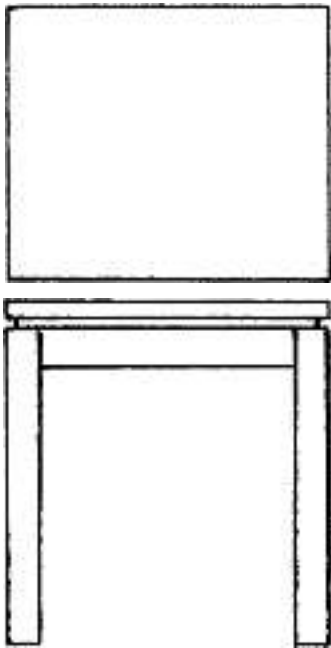

WohnArt 9

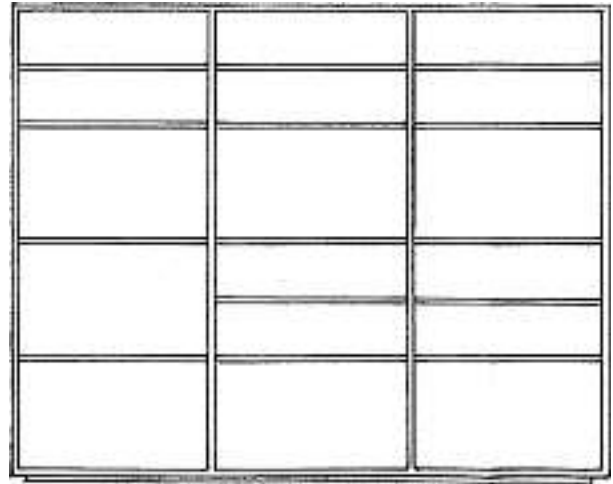

WohnArt 11

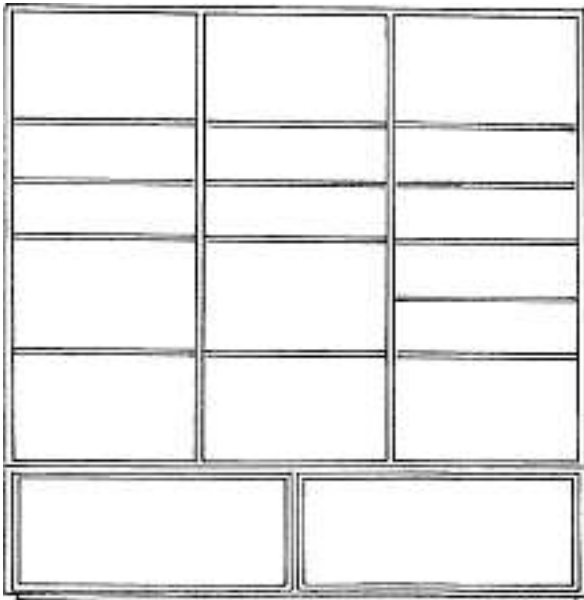

WohnArt 10

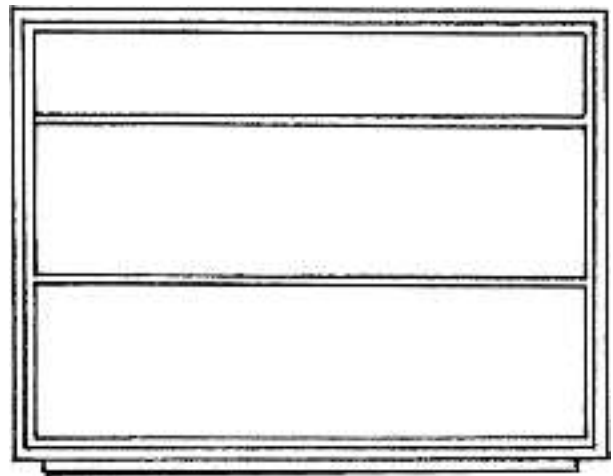

WohnArt 12



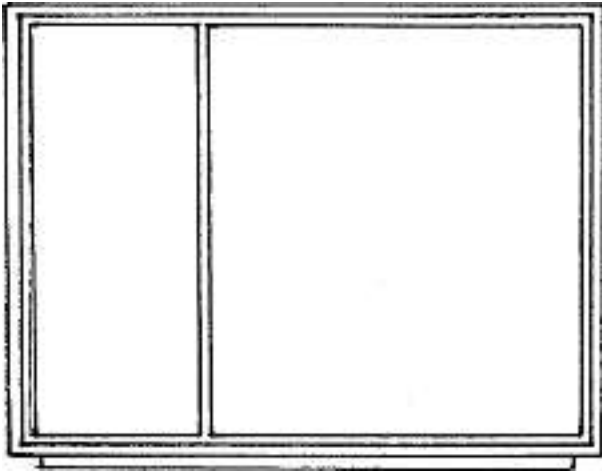

WohnArt 13

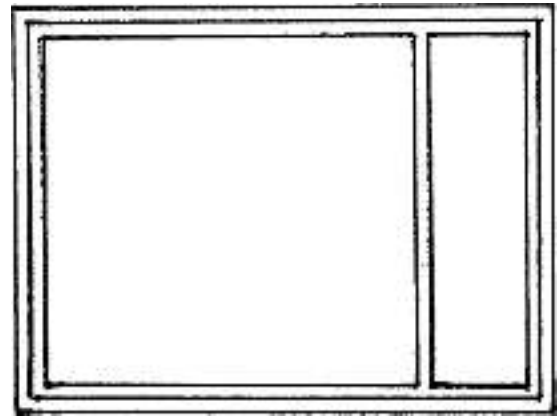
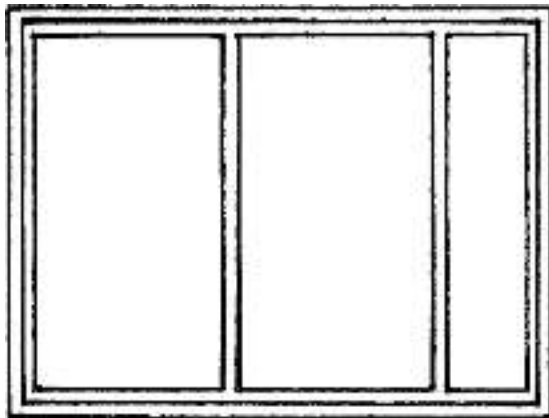

WohnArt 14b

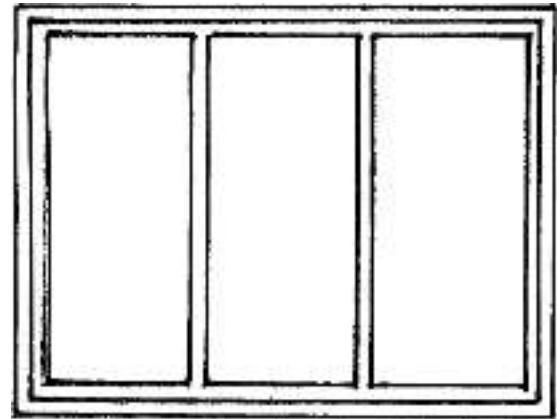

WohnArt 14c

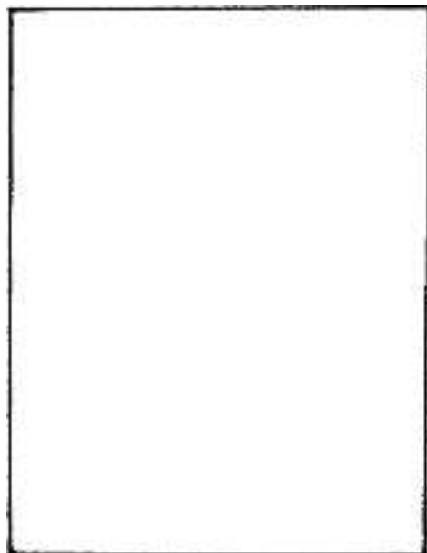
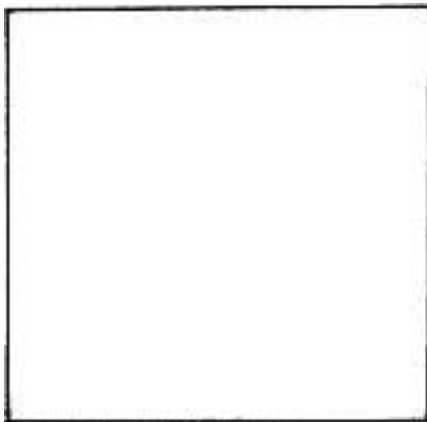

WohnArt 14a

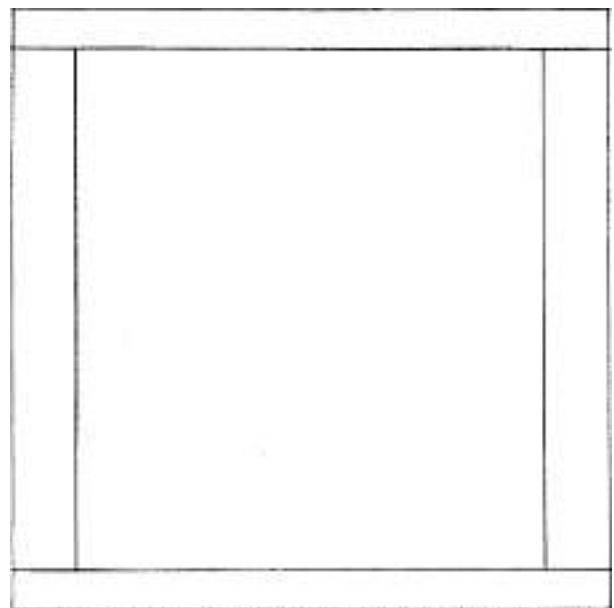

WohnArt 15

Cl. 06-01 **131 822** 17.05.2005
1 Design – Polstersessel
Hinterleger: Designrichtung GmbH, Luisenstrasse 25,
8005 Zürich
Designer: Jérôme Gessaga, Zürich; Christof Hindermann,
Zürich



5004 do_line

Cl. 06-06 **131 823** 09.05.2005
 1 Design – Gestell-Kapselauszug
 Hinterleger: Rainer Gisiger, Zilmattweg 2, 2545 Selzach



Kapselgestell

Cl. 06-06 **131 824** 19.05.2005
 3 Design – Pultaufsatz, Vorlagenhalter
 Hinterleger: Rückenzentrum THERGOfit Zürich GmbH,
 Schaffhauserstrasse 403, 8050 Zürich
 Designer: Michel Ernest Borloz, Otelfingen
 Vertreter: Patentanwaltsbüro Zink, 8173 Neerach



1 geschwungen



2 offen



3 geschlossen

Cl. 06-07 **131 825** 12.05.2005
 1 Design – (Bilder-)Rahmen
 Hinterleger: Karlheinz Hochstrasser, Seewiesstrasse 3,
 8640 Rapperswil SG



framed

Cl. 07-02 **131 826** 27.04.2005
 6 design – macchine per preparare bevande
 Depositante: Bialetti Industrie S.p.A., Via Fogliano, 1,
 Coccaglio (Brescia), IT
 Designer: Alfonso Giannone, Brembate
 Mandatario: Jacobacci & Partners S.A., 1207 Genève

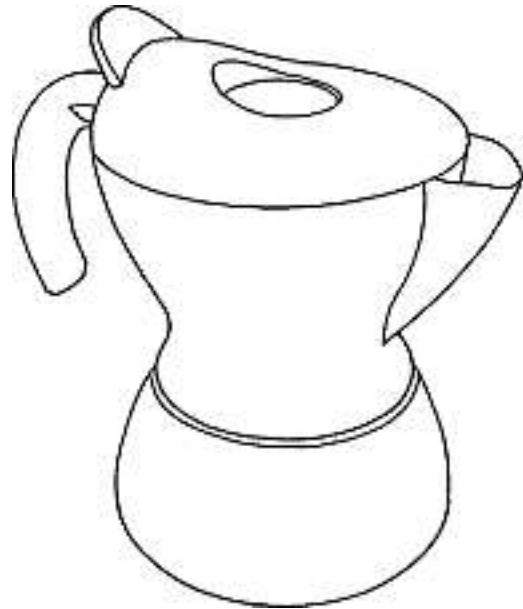

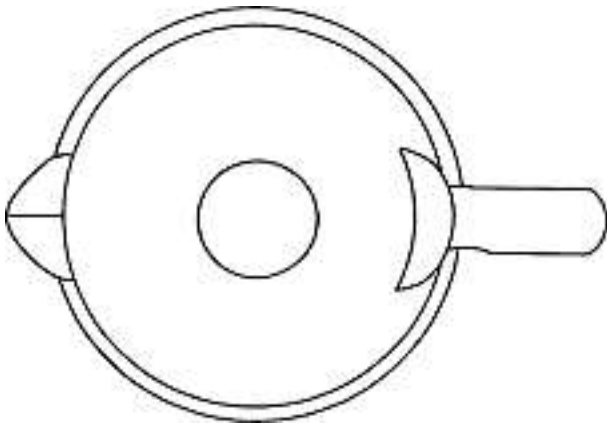

D-1982/05-S1



D-1982/05-S3



D-1982/05-S2





D-1982/05-S4



D-1982/05-S5



D-1982/05-S6



Cl. 07-02 **131 827** 19.05.2005

1 design – carafe bouilloire
 Déposant: Heinz Lamprecht, Wachtstrasse 2, 6315 Morgarten
 Designer: Jean-Luc Thuliez, La Neuveville
 Mandataire: Cabinet Roland Nithardt, Conseils en Propriété Industrielle SA, 1400 Yverdon-les-Bains
 Description du design: «Corps de la carafe, à l'exception du couvercle et du réceptacle du système de chauffe, et poignée d'un seul tenant en matière synthétique transparente d'aspect proche du verre».





10810

Cl. 08-05 **131 828** 04.05.2005
 1 Design – Tablettenpresse
 Hinterleger: Roger W. Vollenweider, Wydenweg 22a,
 8408 Winterthur
 Vertreter: patentanwälte breiter + wiedmer ag,
 8413 Neftenbach



VOR-1

Cl. 08-06 **131 829** 12.05.2005
 13 Design – Fenstergriffe
 Hinterleger: HOPPE AG, Am Plausdorfer Tor 13,
 Stadtallendorf, DE
 Designer: Walter Holzappel, Frankenberg-Eder / Röddenau
 Vertreter: PA Aldo Römpler, 9410 Heiden
 Priorität: EM, 10.12.2004

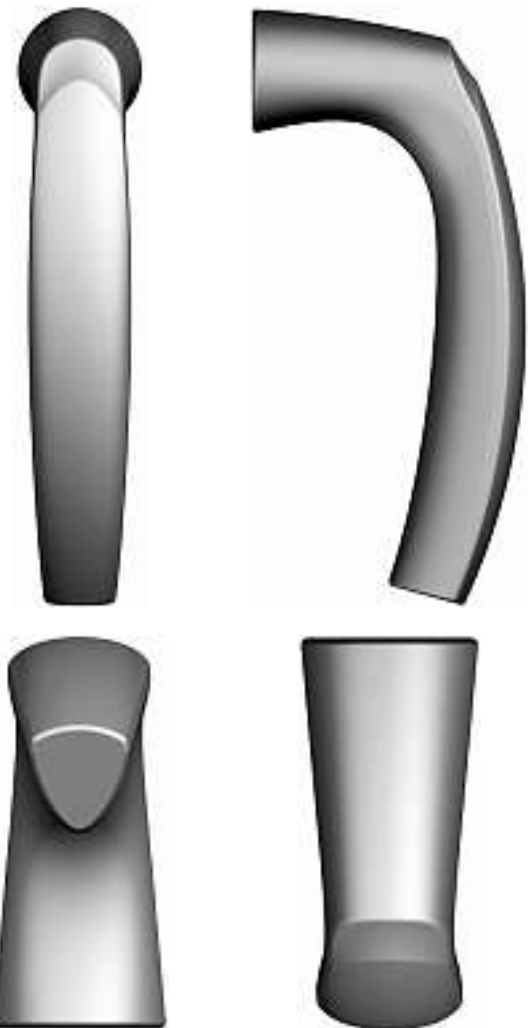



2

1





3



4

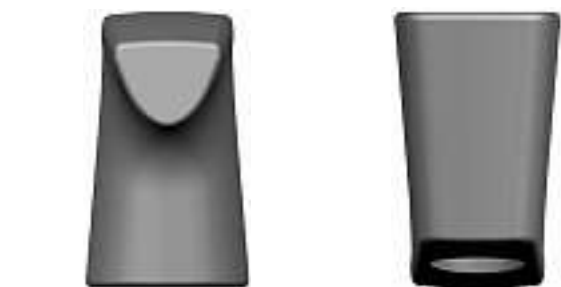

5

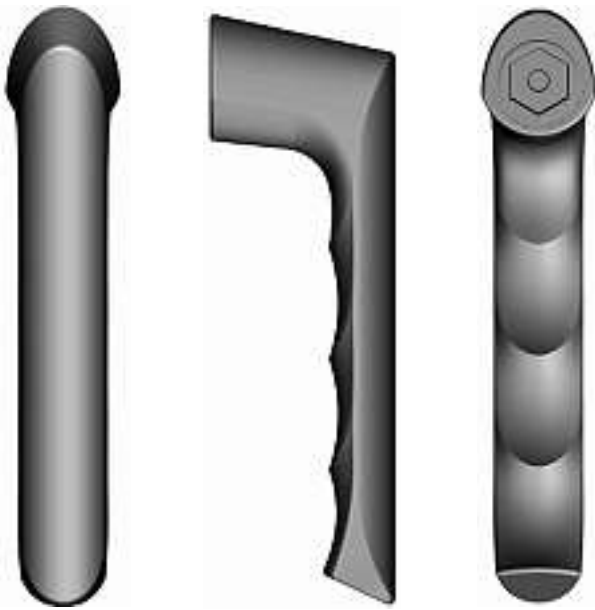

7



6



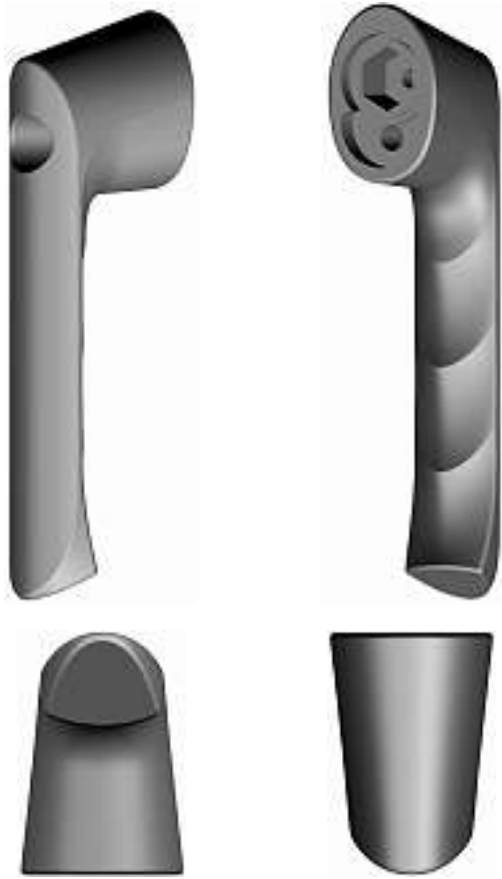

8

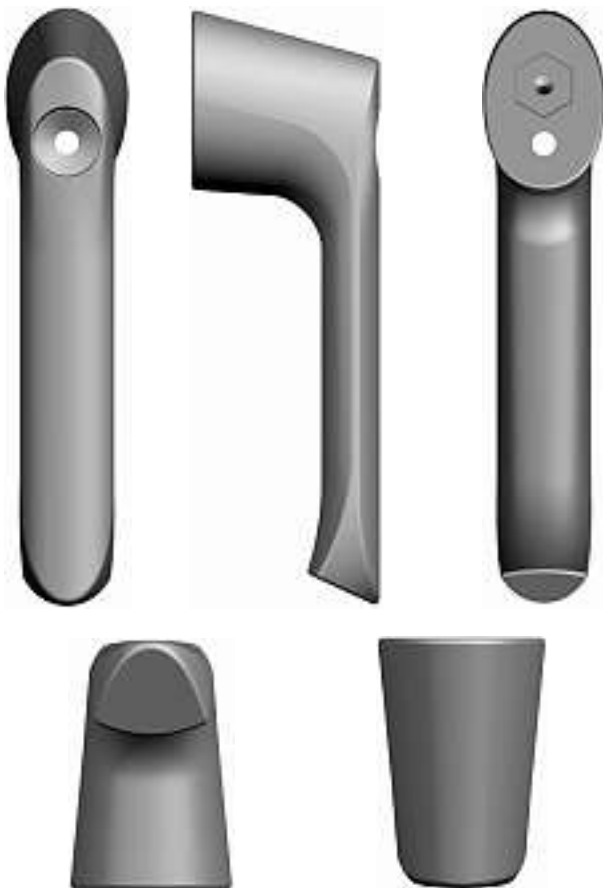

9



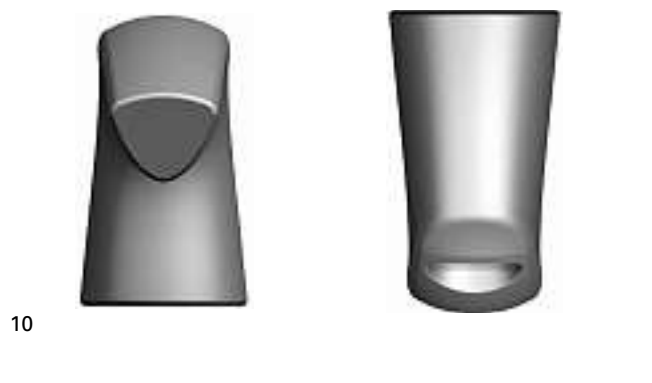

10

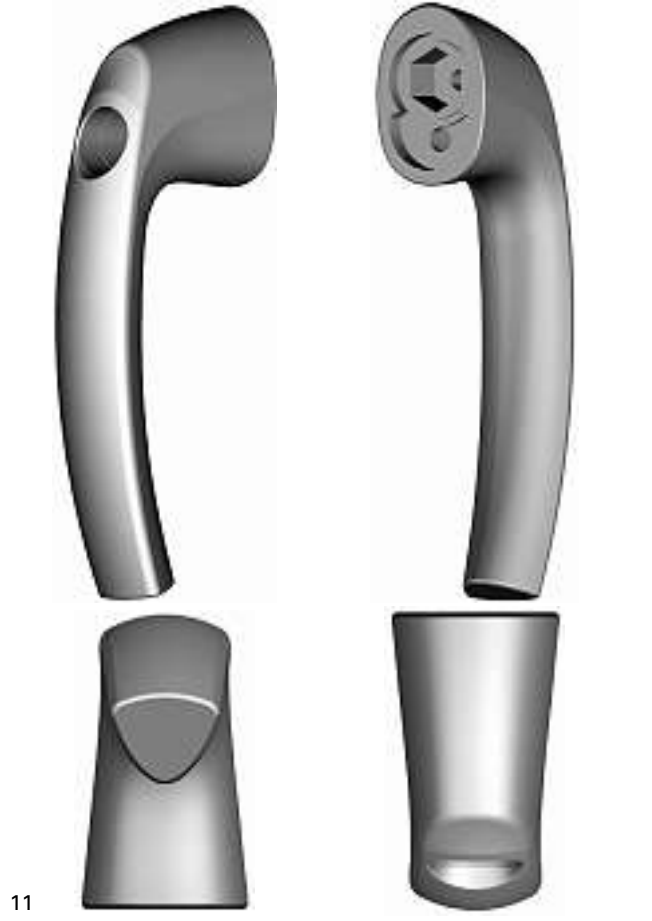

11



12



13



Cl. 09-01 131 830 12.05.2005
 6 design – bouteilles
 Déposant: Société Autonome de Verreries, Place de la Gare,
 Feuquières, FR
 Designer: Didier Rica, Le Mont Saint Adrien
 Mandataire: Inteltech SA, 2001 Neuchâtel
 Priorité: EM, 22.11.2004





J1

Description du design: L'originalité de cette carafe réside dans les caractéristiques suivantes:
 Une silhouette compacte et masculine, Une section rectangulaire avec des faces principales bombées, 2 larges faces (en vue de facing) légèrement coniques, Des angles aigus aux 4 extrémités, Un profil étroit, Des épaisseurs de verre importantes, notamment sous forme d'une épaisse semelle de verre à la base et de «colonnes» latérales, Un épaulement vif et tranchant presque horizontal, Un col court qui peut être muni de différents types de bagues.
 Ce modèle peut faire l'objet d'une déclinaison en diverses contenance utiles.

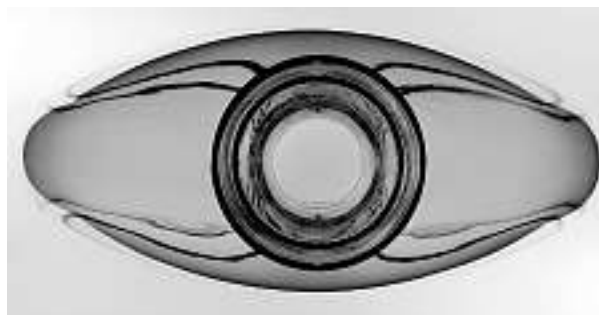



T2

Description du design: L'originalité de cette carafe réside dans :
 la section ovale et large du modèle, un corps en forme d'ogive, un facing généreux, un profil étroit, un épaulement fuyant, une épaisse semelle de verre, un col cylindrique court.
 Ce modèle peut faire l'objet d'une déclinaison en diverses contenance utiles et différentes versions de bagues.



S3



Description du design: Cette bouteille à vocation vin tranquille, se distingue par:
 Une silhouette ovale, longiligne et élancée, légèrement rentrante au niveau du bas-fût, Une section cylindrique du corps de la bouteille, Un épaulement faisant partie du fût de la bouteille, Un col cylindrique formant une rupture nette avec le corps de la bouteille et pouvant être muni de différents types de bagues, Un fond plat constituant une originalité complémentaire pour une bouteille de vin, Une petite semelle de verre plate.
 Ce modèle peut faire l'objet d'une déclinaison en diverses contenance utiles.



Description du design: Ce modèle de bouteille de type BOURGUIGNONNE se singularise par sa silhouette massive, son corps cylindrique d'un diamètre généreux, un col légèrement conique, un jable nerveux conférant sa noblesse au modèle. Il est muni d'une bague à vis de type «Stelvin».





N5

Description du design: Cette bouteille de section ronde se distingue par l'élégance sobre de sa ligne que lui confèrent: la forme conique de son fût; un épaulement vif et tranchant, presque horizontal; une semelle de verre très épaisse; un col cylindrique relativement fort et court. Sa silhouette épurée et géométrique en fait un modèle avant-gardiste. Le modèle existe en plusieurs versions de bagues et peut être décliné en plusieurs contenances.





O6

Description du design: Ce modèle se distingue par l'élégance sobre de sa ligne que lui confère: Son corps cylindrique, son épaule très arrondie, son col relativement court et cylindrique, un petit rayon de raccordement col/épaule, des ouies de préhension sur la face arrière du flacon, un fond plat muni d'une épaisse semelle de verre. Ce modèle peut faire l'objet d'une déclinaison en diverses contenance utiles et différentes versions de bagues.

Cl. 09-01 131 831 18.05.2005

1 design – bouteille

Déposant: Société Autonome de Verreries, Place de la Gare, Feuquières, FR

Designer: Didier Rica, Le Mont Saint Adrien

Mandataire: Inteltech SA, 2001 Neuchâtel

Description du design: Ce modèle de type bourguignonne se caractérise par une silhouette massive et particulièrement galbée. L'épaule est placée assez bas par rapport au corps. Le fût de la bouteille présente une forme très bombée et se rétrécissant à sa base. Le col est muni d'une bague carrée proéminente. Le fond de la bouteille est pourvu d'une profonde piqûre.



1

Cl. 09-03 131 832 21.04.2005

1 Design – Zigarettenpackung

Hinterleger: British American Tobacco (Germany) GmbH, Alsterufer 4, 20354 Hamburg, DE

Designer: David Villiers, London

Vertreter: Riederer Hasler & Partner Patentanwälte AG, 7310 Bad Ragaz

Beschreibung des Designs: Die beiliegende Zeichnung, Ansicht 1.1, zeigt eine Draufsicht auf eine Zigarettenpackung mit geöffnetem Deckel und einer V-förmig ausgeschnittenen Zarge.

Das beiliegende Foto, Ansicht 1.2, stellt in einer ähnlichen Ansicht wie die Zeichnung eine Zigarettenpackung mit V-förmig ausgeschnittener Zarge dar, die farbig, in diesem Fall in Gold-Farbe, ausgelegt ist.

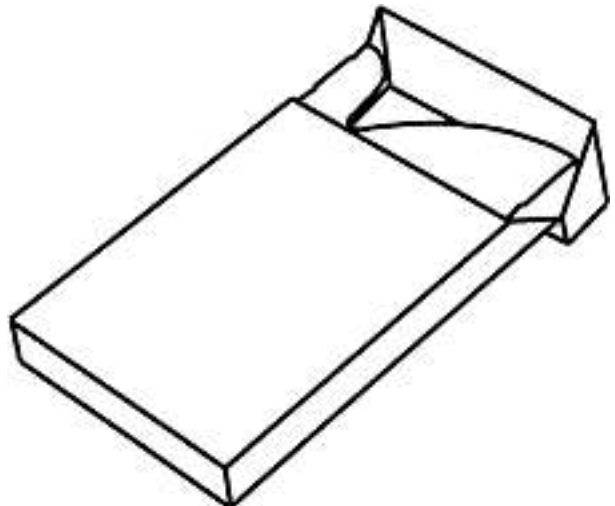



1



1

Cl. 09-03 **131 833** 03.05.2005
 2 Design – Verpackungen
 Hinterleger: Pawi Verpackungen, Grüzefeldstrasse 63,
 8411 Winterthur
 Designer: Stephan Springer, Winterthur



2

Cl. 09-03 **131 834** 03.05.2005
 1 Design – Verpackung
 Hinterleger: Pawi Verpackungen, Grüzefeldstrasse 63,
 8411 Winterthur
 Designer: Stephan Springer, Winterthur





3

Cl. 09-03 131 835 03.05.2005
 1 Design – Verpackung
 Hinterleger: Pawi Verpackungen, Grüzefeldstrasse 63,
 8411 Winterthur
 Designer: Stephan Springer, Winterthur



4

Cl. 09-05 131 836 24.05.2005
 2 Design – Spender
 Hinterleger: Holopack International Corp., Carolina Research
 Park, 1 Technology Circle, Columbia / SC, US
 Designer: Walter Zahn, Columbia; Shawn W. Miller,
 Columbia; David Rocheleau, Lexington; Mohammad R.
 Sadeghi, Columbia; Bernd Hansen, Sulzbach-Laufen
 Vertreter: Isler & Pedrazzini AG, 8023 Zürich
 Priorität: US, 24.11.2004; US, 24.11.2004

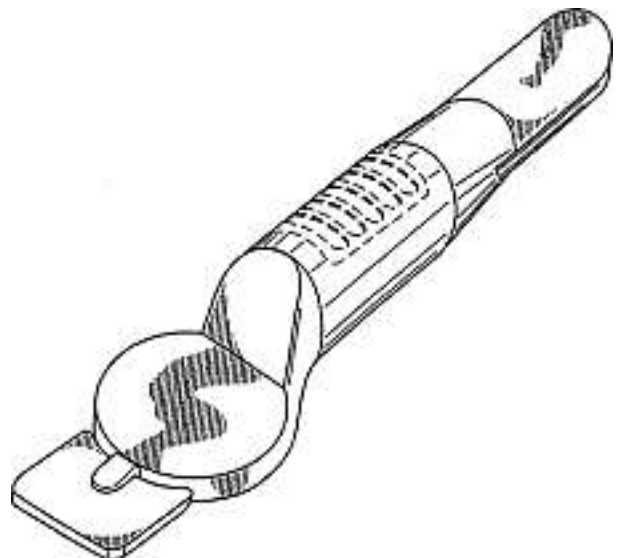
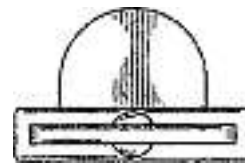
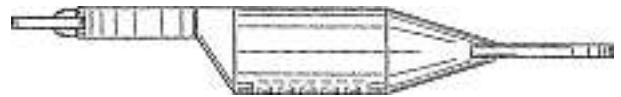
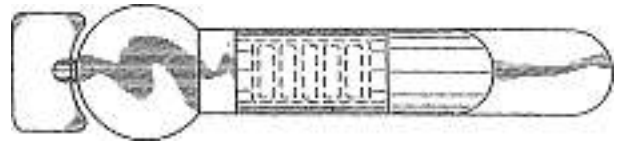

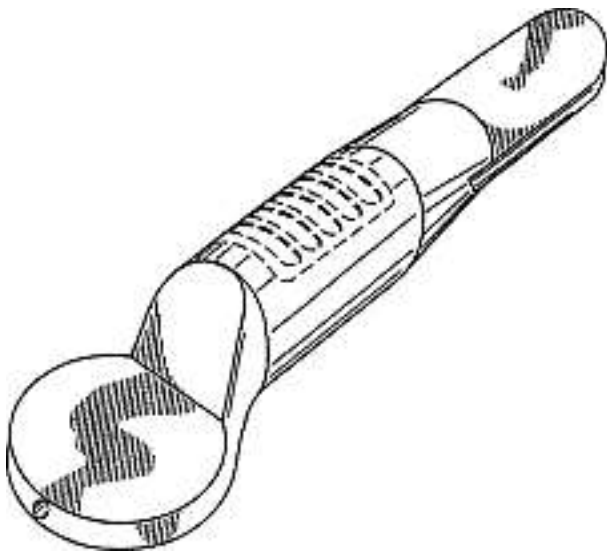

M13034-1



M13034-2

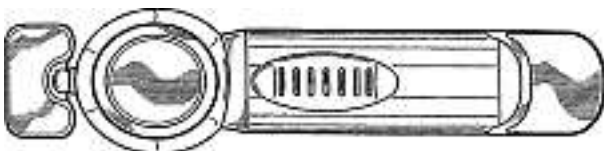
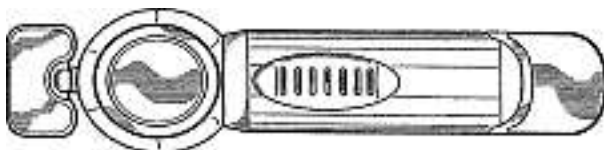
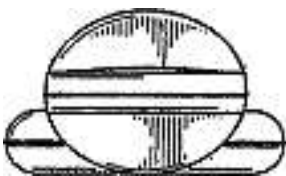
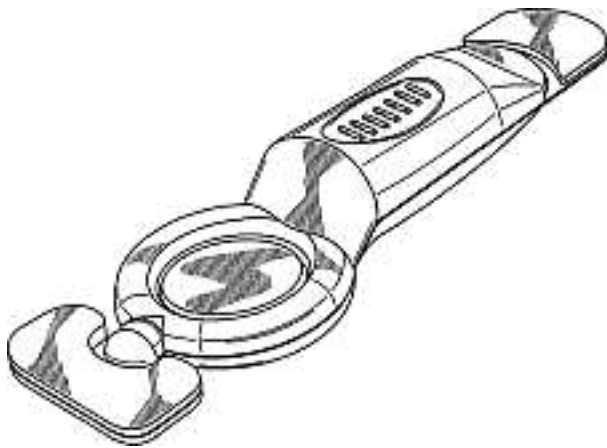

Cl. 10-07 **131 839** 29.04.2005

4 design – boîtes de montre; cadrans avec aiguilles

Déposant: Jérôme de Witt, 40 route de Pressy,
1253 Vandoeuvres

Mandataire: Micheli & Cie, 1226 Thônex (Genève)

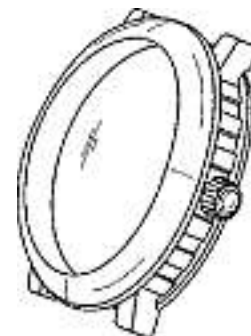
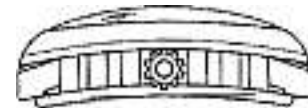
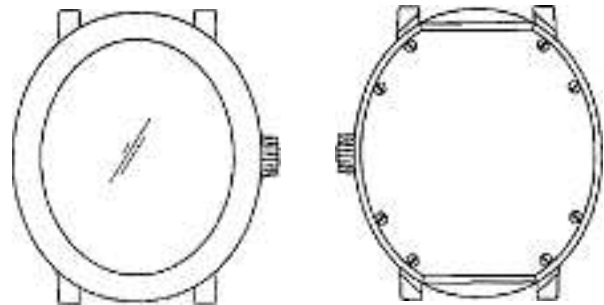

14311 A

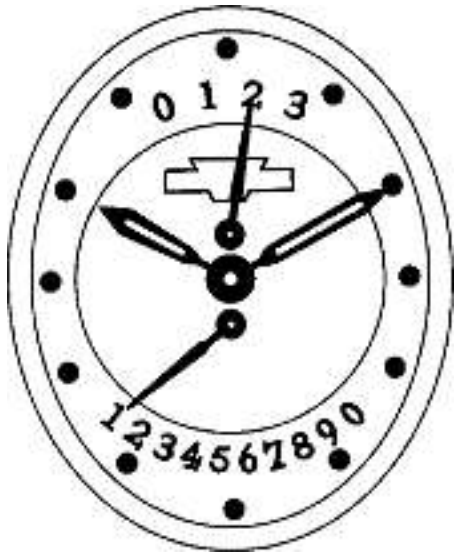

14311 B

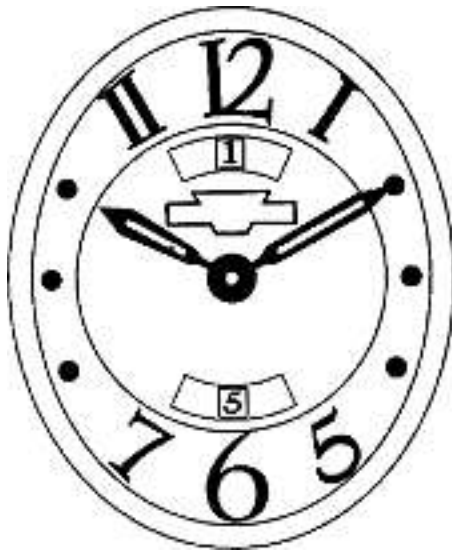

14311 C

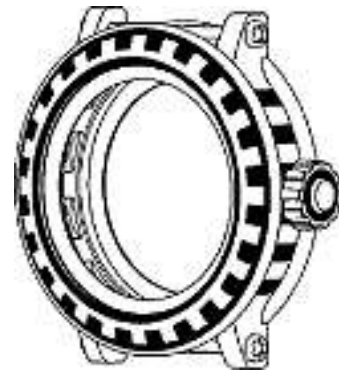
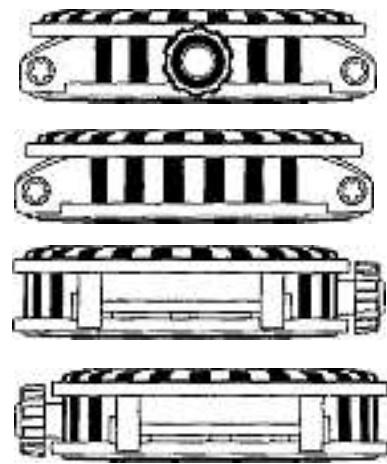
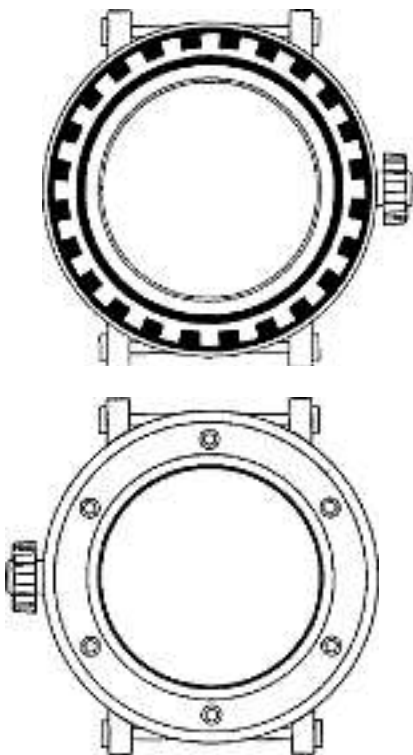

14311 D

Cl. 10-07 **131 840** 29.04.2005
 4 design – boîtiers de montre; carrure pour boîtier de montre;
 profil d'un boîtier de montre
 Déposant: Voltige S.A., Route de l'Aéroport 15, 1215 Genève
 Designer: Stéphane Varak, Vernier
 Mandataire: Griffes Consulting S.A., 1206 Genève

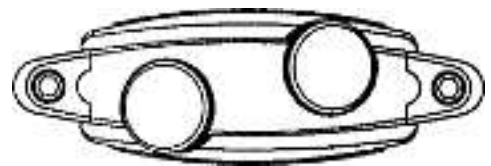
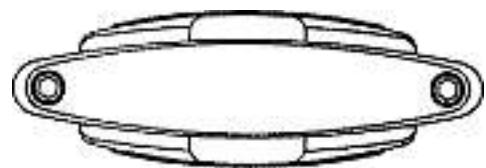
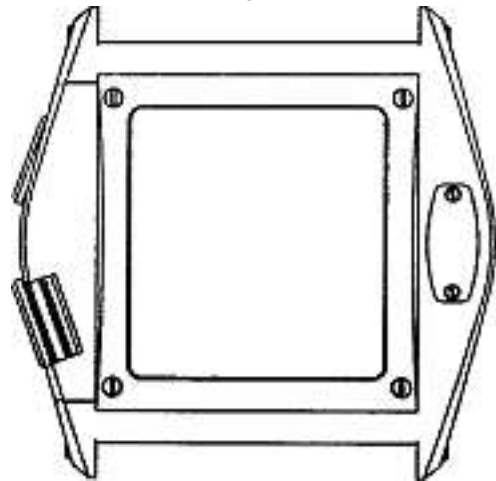

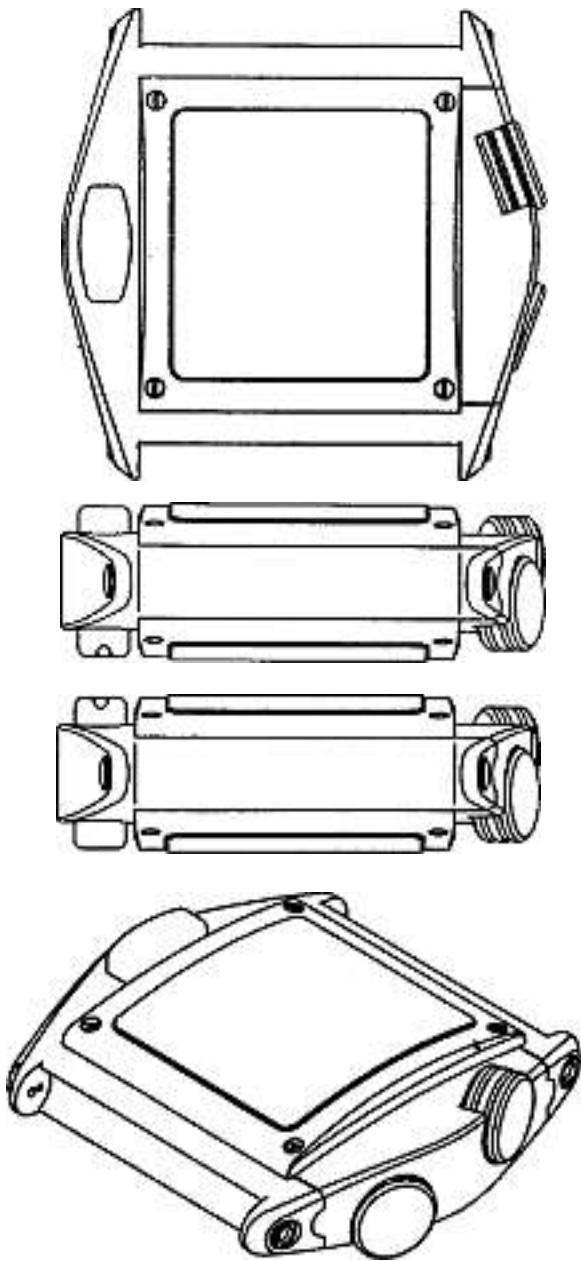

MO-50010-CH

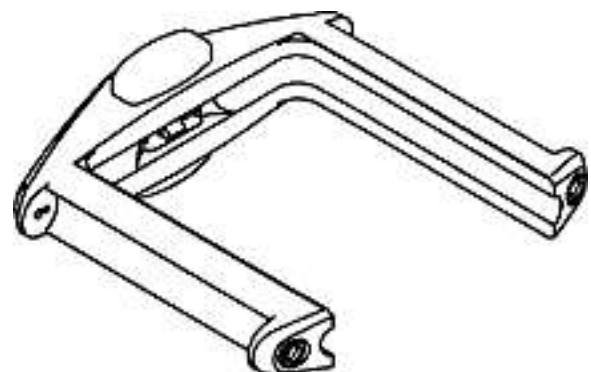
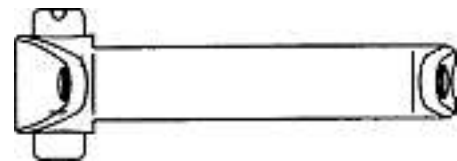
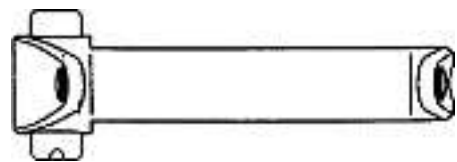
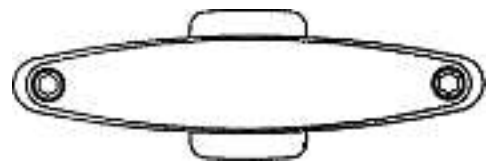
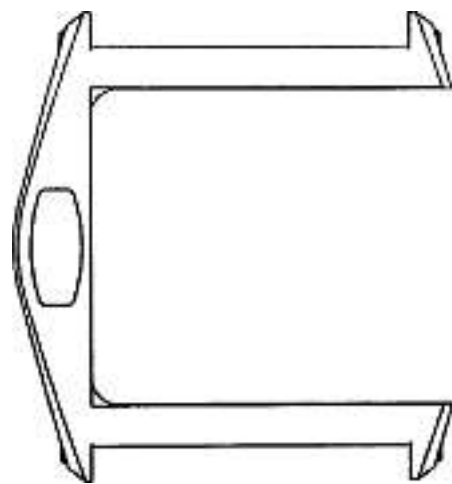
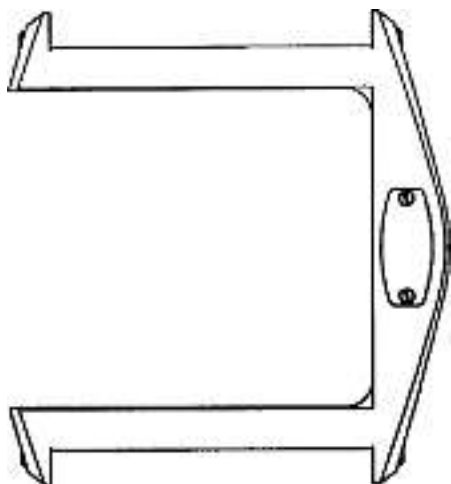

MO-50011-CH

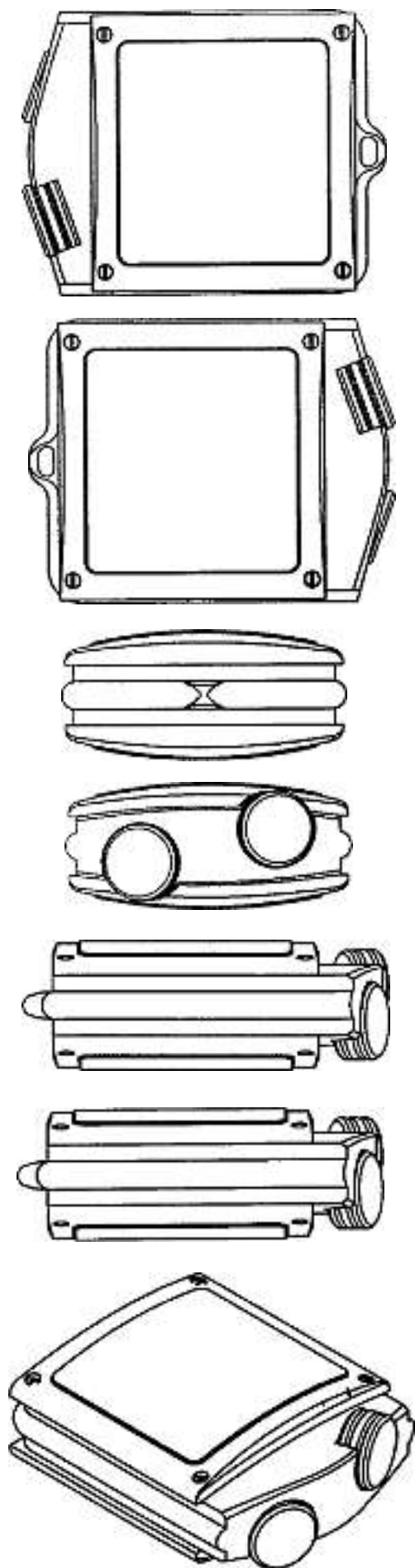

MO-50012-CH

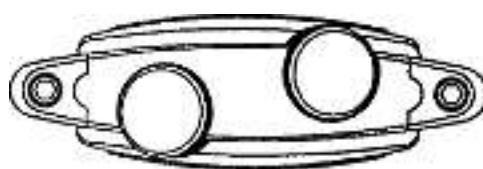

MO-50013-CH

Cl. 10-07 **131 841** 03.05.2005
 1 design – cadran de montre
 Déposant: Amarildo Pilo, 11, rue Leschet, 1205 Genève
 Mandataire: Bugnion S.A., 1211 Genève 12 - Champel



No 1

Cl. 12-15 **131 842** 23.05.2005
 1 design – pneumatico per veicoli
 Depositante: Pirelli Pneumatici S.p.A., Viale Sarca 222,
 20126 Milano, IT
 Designer: Alexandre Sorrentino Gerasimczuk, Milano
 Mandatario: Fiammenghi-Fiammenghi, 6900 Lugano
 Priorità: EM, 10.12.2004

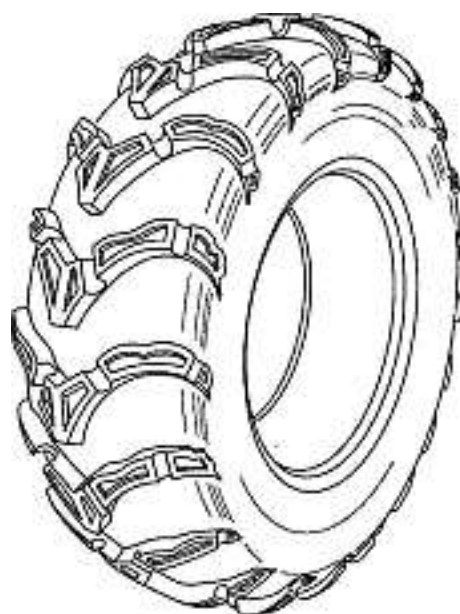



450

Cl. 14-03 **131 843** 06.05.2005

3 Design – Basisstation mit Headset

Hinterleger: GN Netcom A/S, Metalbuen 66, 2750 Ballerup, DK

Designer: Klaus Rath, Gentofte

Vertreter: Frei Patentanwaltsbüro, 8032 Zürich

Priorität: EM, 22.11.2004

Beschreibung des Designs: Kabelloses Headset mit Basisstation, welche ein Ladegerät zum Laden einer Batterie im Headset enthält.

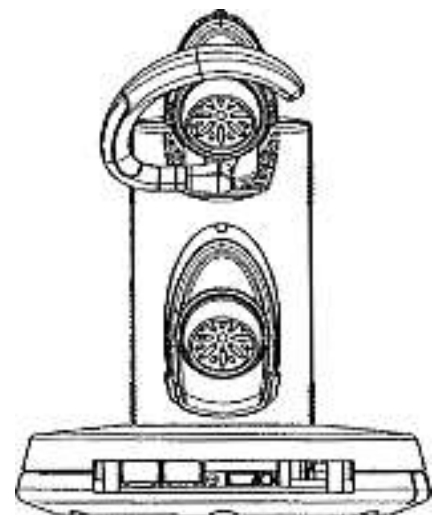
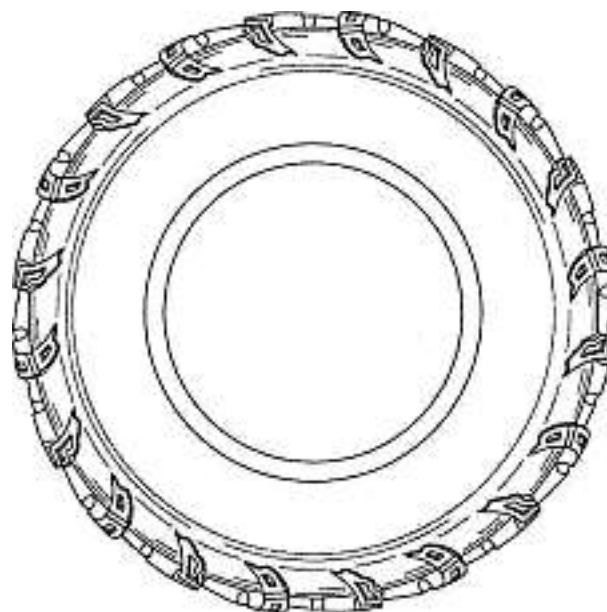
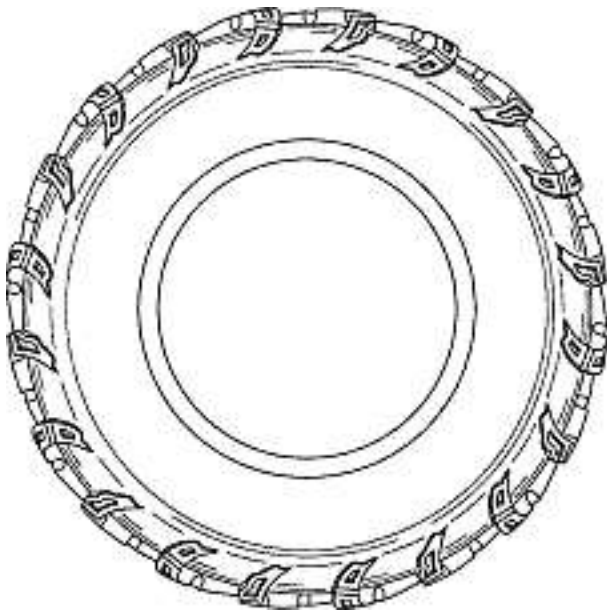

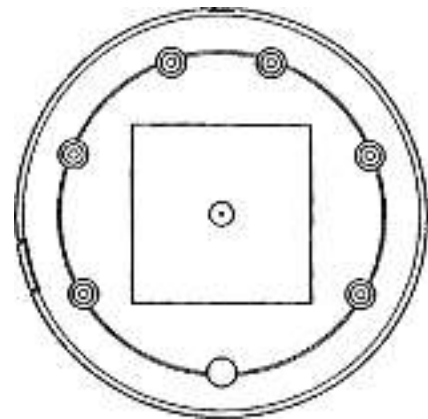
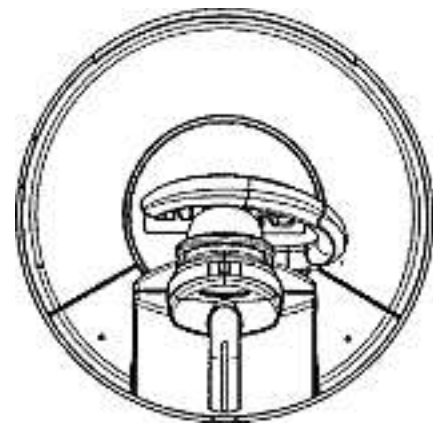
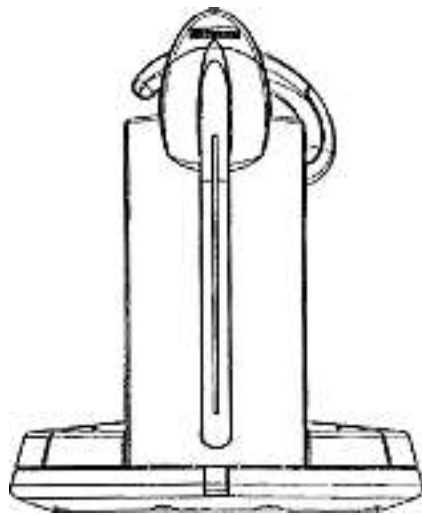

1

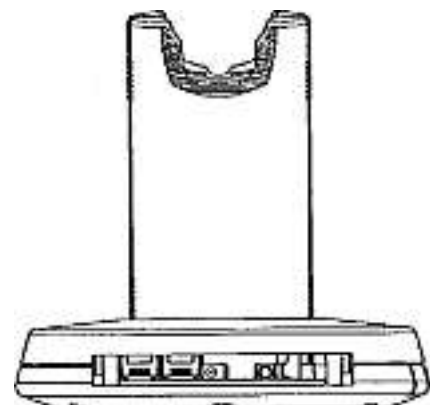
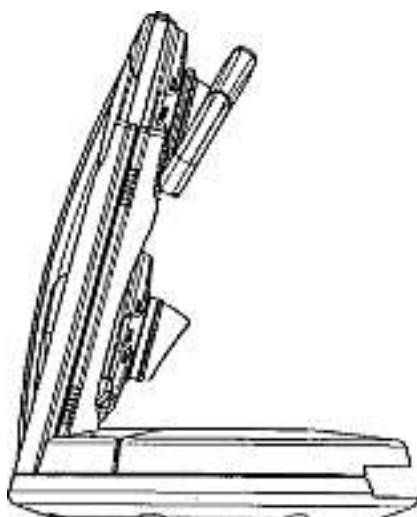
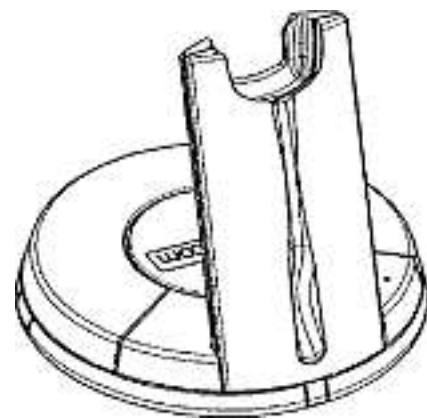
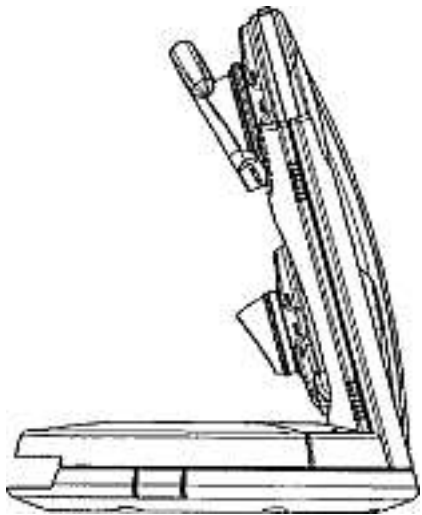

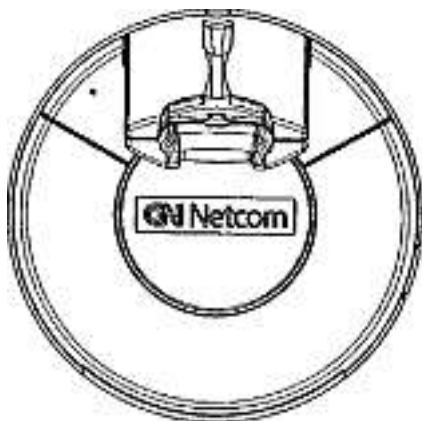
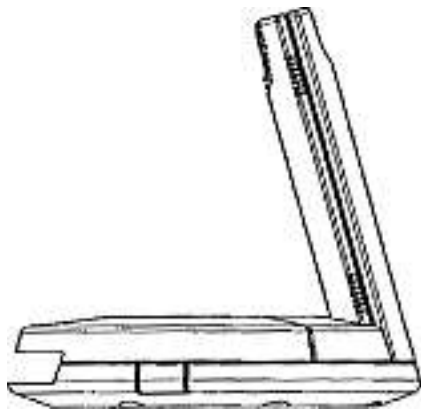
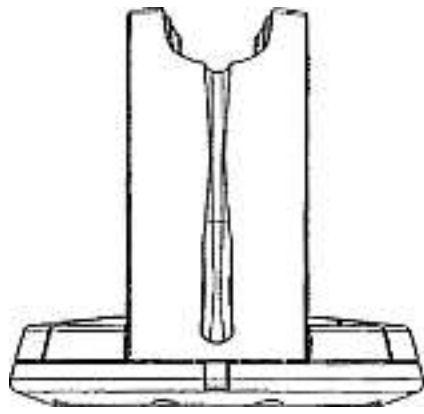

2

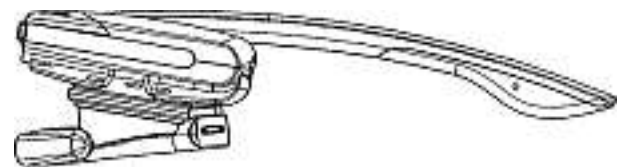
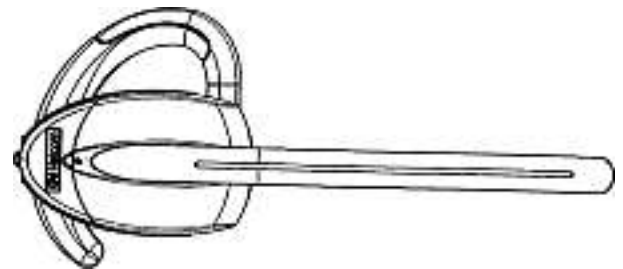
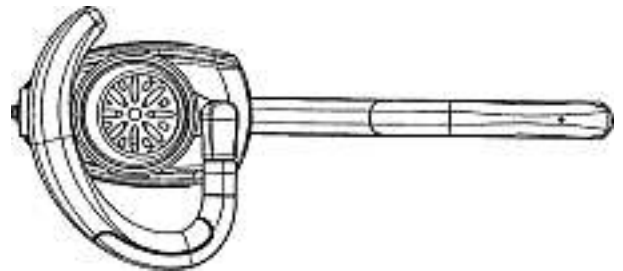
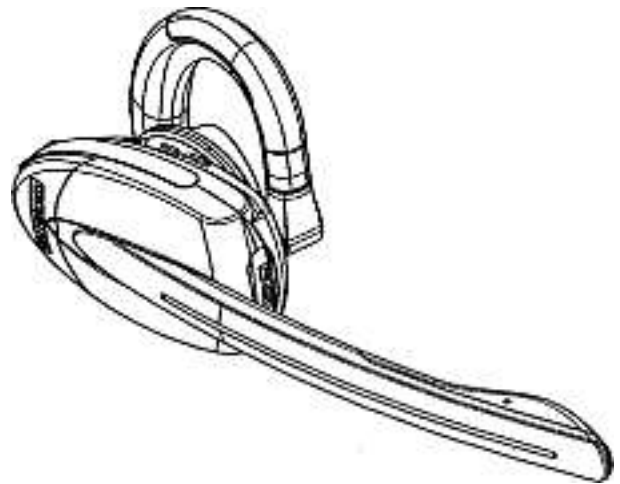
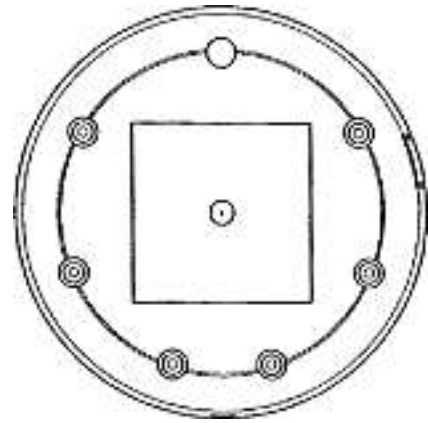

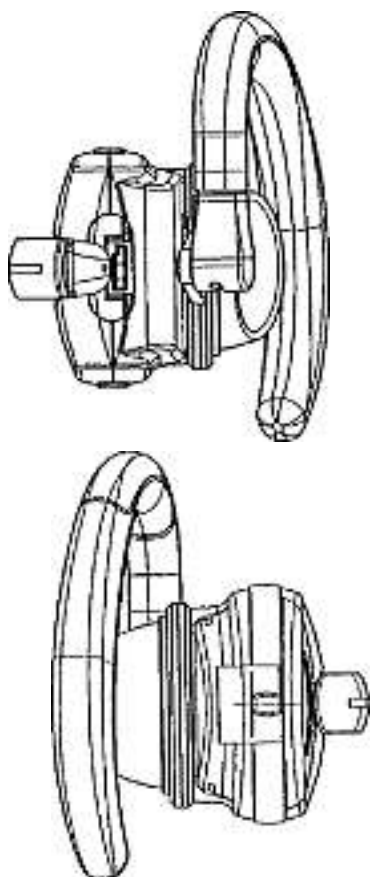

3

Cl. 15-05 **131 844** 06.05.2005
1 Design – Staubsauger
Hinterleger: BSH Bosch und Siemens Hausgeräte GmbH,
Carl-Wery-Strasse 34, München, DE
Designer: Jörg Schröter, Gröbenzell
Vertreter: Isler & Pedrazzini AG, 8023 Zürich
Priorität: EM, 09.11.2004





M13028



A-2005/1020b

Cl. 16-01 **131 845** 22.04.2005
 2 Design – Videokamera
 Hinterleger: Logitech International S.A., Moulin du Choc,
 1122 Romanel-sur-Morges
 Designer: Paul E. Bradley, Palo Alto; Chris Loew, Palo Alto;
 Jochen P. Backs, San Francisco; Cam Le, San Jose
 Vertreter: E. Blum & Co., 8044 Zürich



A-2005/1020a

Cl. 19-01 **131 846** 12.05.2005
 3 Design – Couverts
 Hinterleger: Martin Egli, Säntisstrasse 32, 8311 Brütten

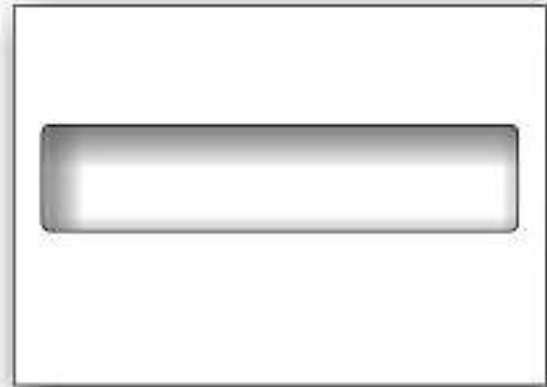

C4

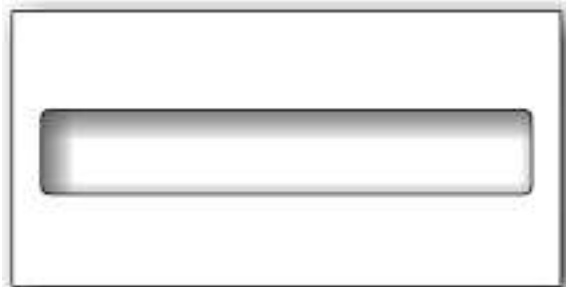

C5

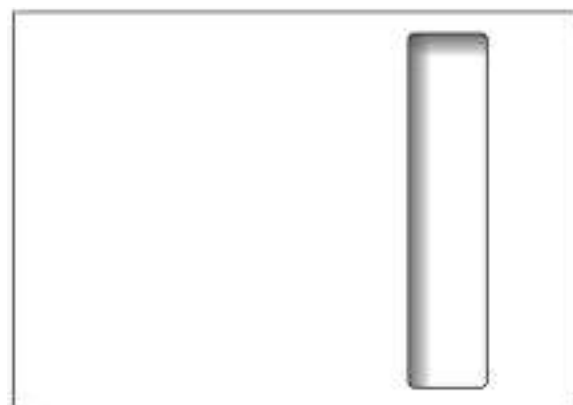

C5/6

Cl. 19-08 131 847 09.05.2005
 4 Design – Druckerzeugnisse
 Hinterleger: Studienkreis GmbH, Universitätsstrasse 104,
 44799 Bochum, DE
 Designer: Rainer Lorenz, Reutlingen
 Vertreter: Heisel & Oldekop, c/o Muri Rechtsanwälte,
 8570 Weinfeldern
 Priorität: DE, 10.11.2004



000457-M/1

studienkreis
 000457-M/2

studienkreis
 > Nachhilfe.de

000457-M/3



000457-M/4

Cl. 19-08 131 848 11.05.2005
 2 Design – Druckvorlagen
 Hinterleger: Stop-Insekt Schädlingbekämpfungsgesellschaft GmbH,
 Falkensteinstrasse 1, 9006 St. Gallen
 Designer: Roger Frei, Winterthur



Stop Insekt-Tafel



Wespe

Cl. 19-99 131 849 12.05.2005
 3 Design – Bürobedarfsmagnete, Magnettafeln
 Hinterleger: Karlheinz Hochstrasser, Seewiesstrasse 3,
 8640 Rapperswil SG

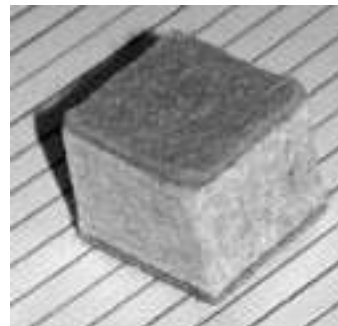

wild things



on board



boarding time

Cl. 20-02 **131 850** 18.05.2005
 1 Design – Steller
 Hinterleger: Bruno Messerli, Hauptstrasse 106, Brittern,
 4587 Aetingen

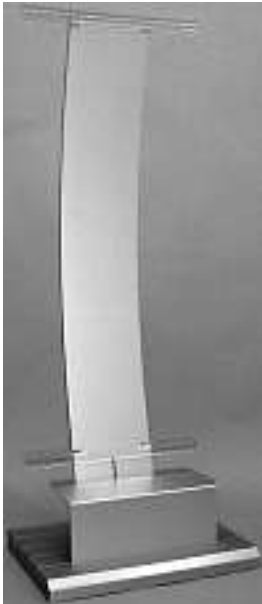

Sanestra al

Cl. 20-02 **131 851** 18.05.2005
 1 Design – Steller
 Hinterleger: Bruno Messerli, Hauptstrasse 106, Brittern,
 4587 Aetingen



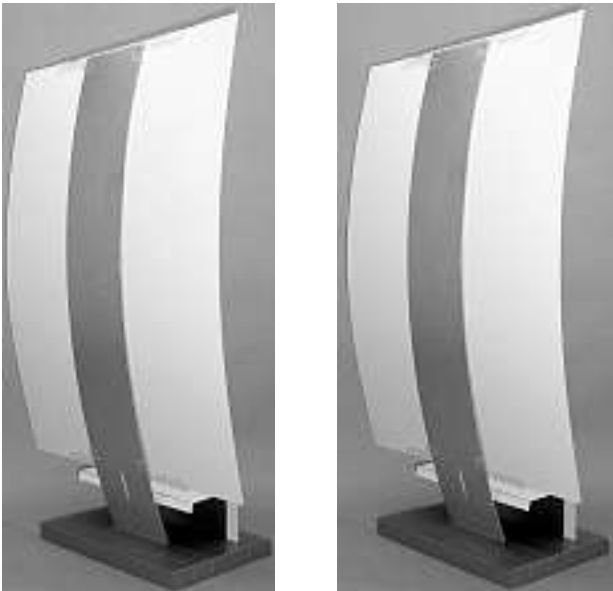

Sanestra pl

Cl. 21-01 131 852 12.05.2005
26 Design – Spielkarten
Hinterleger: Ernst Ingold, Kurzfeldstrasse 15, 8500 Frauenfeld

1

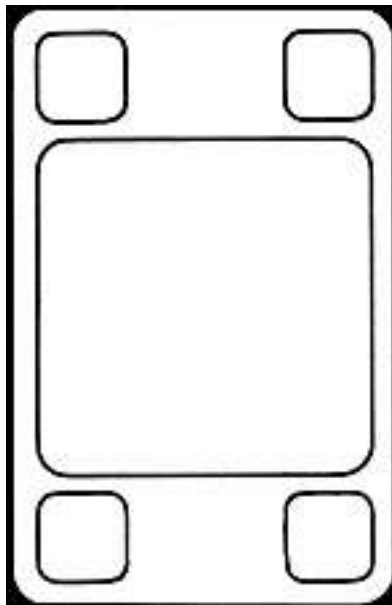

2

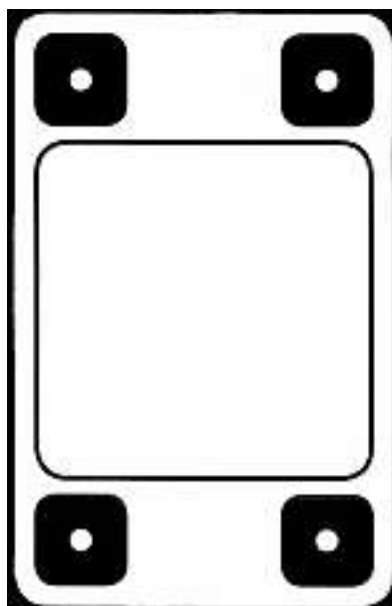

3

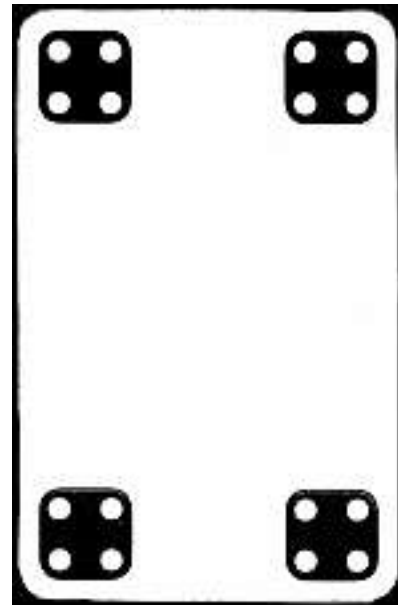

4

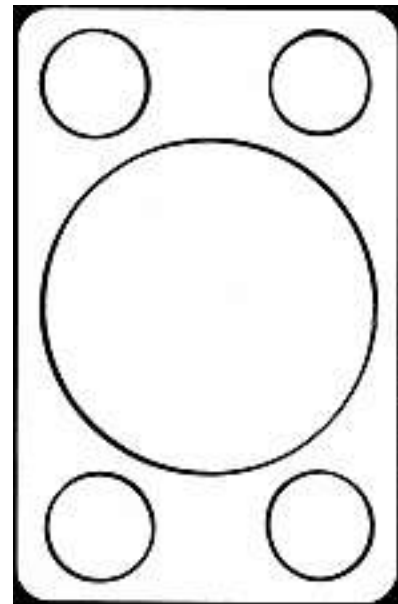

5

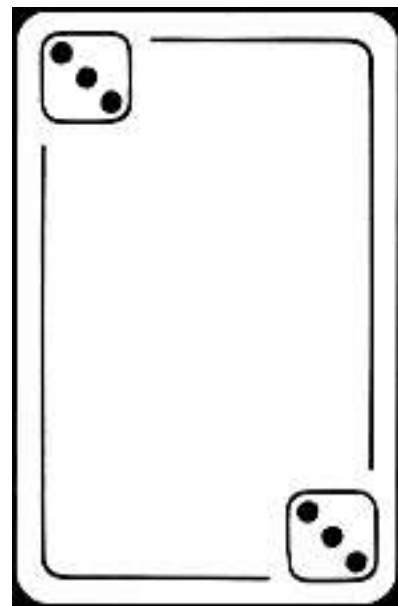

6

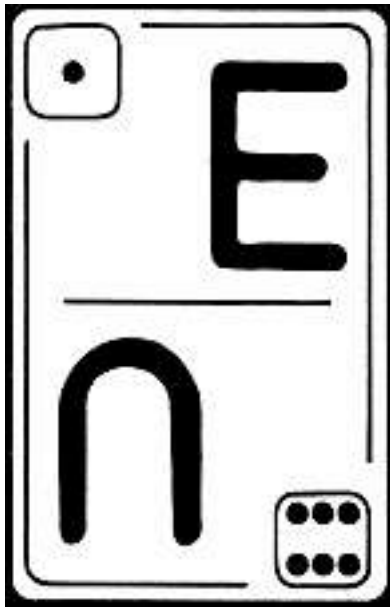

9

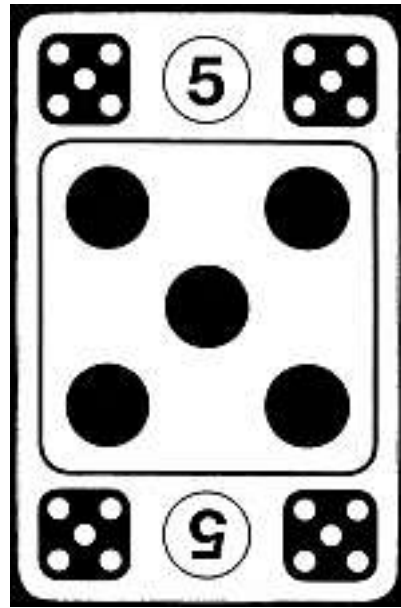

7

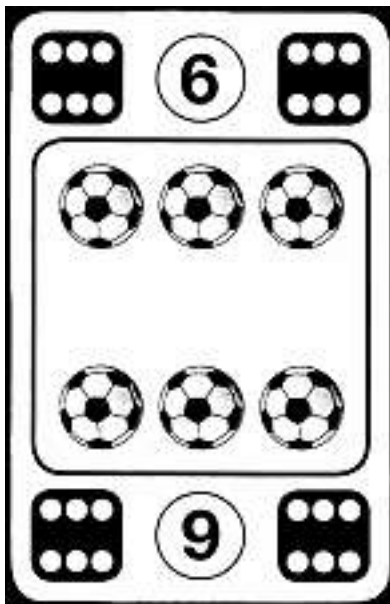

10

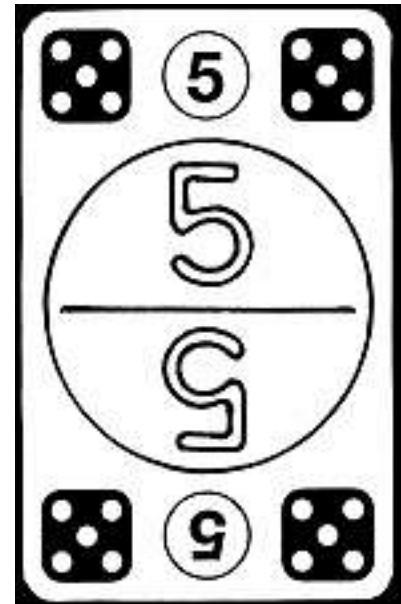

8

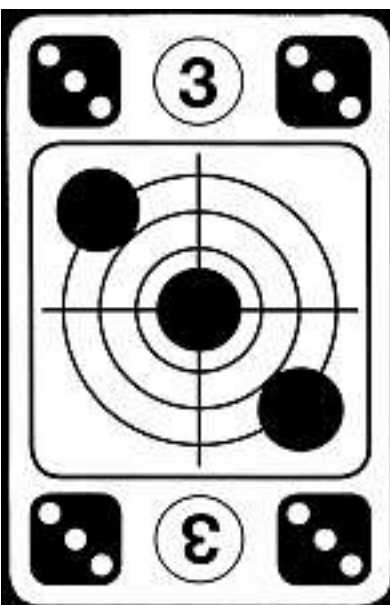

11



12

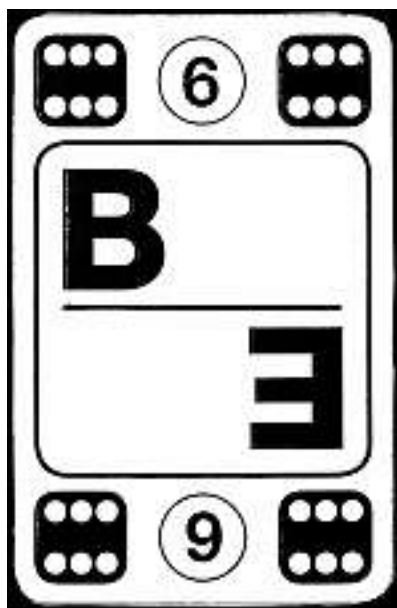

13

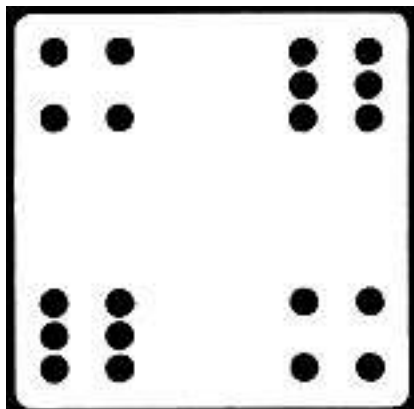

14

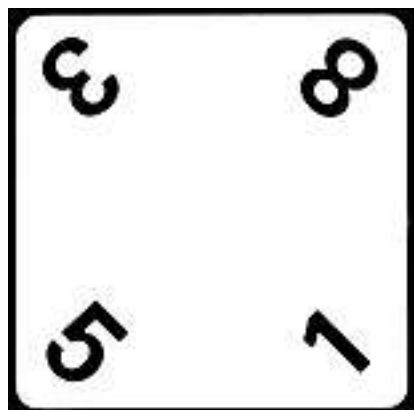

15

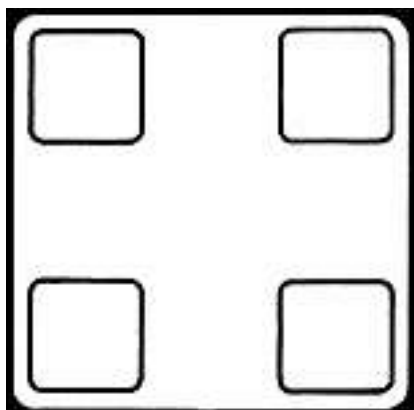

16

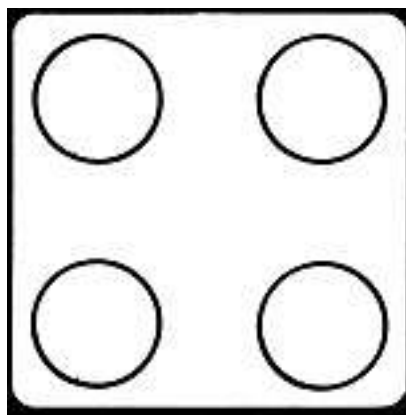

17

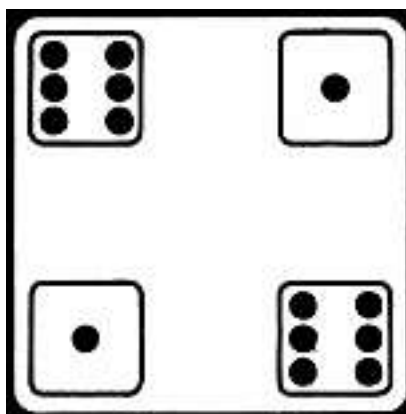

18

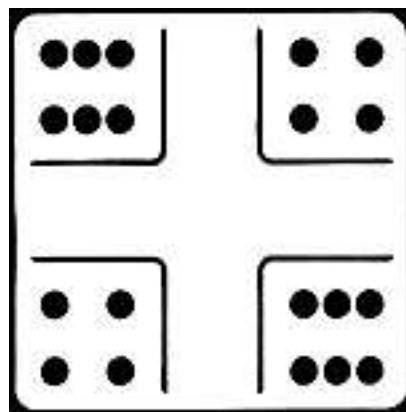

19

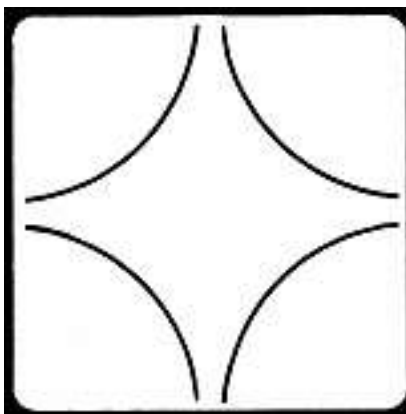

20

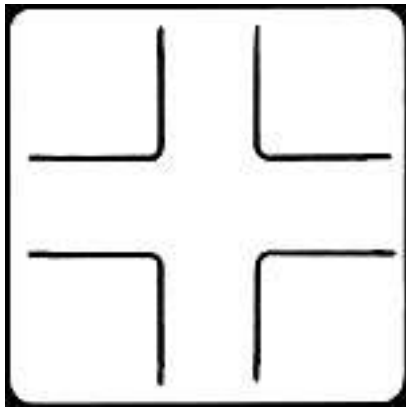

21

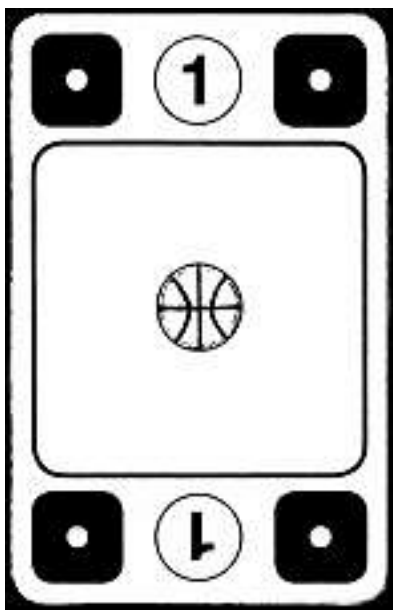

22

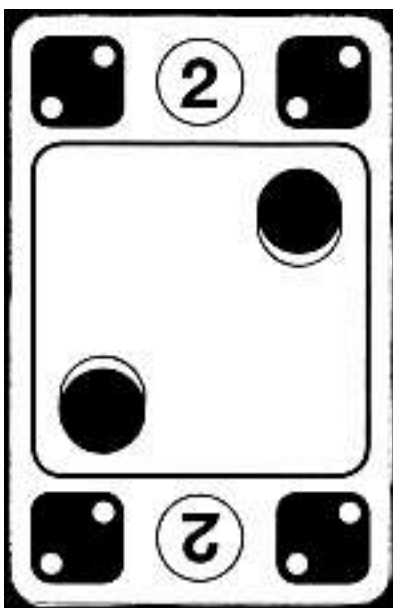

23

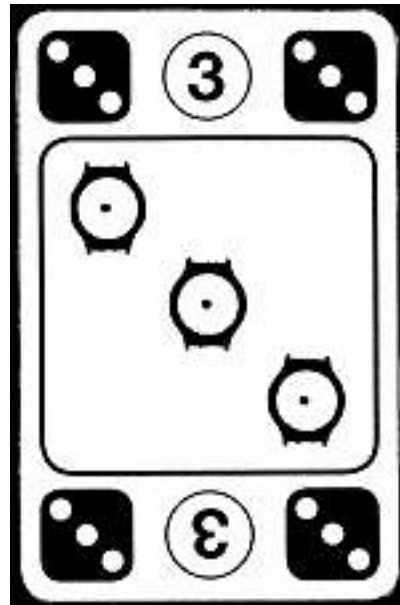

24

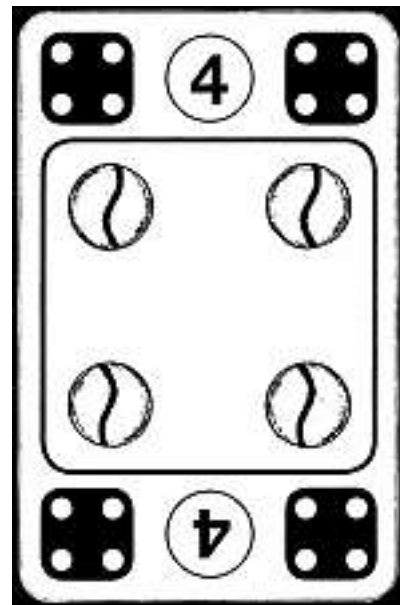

25

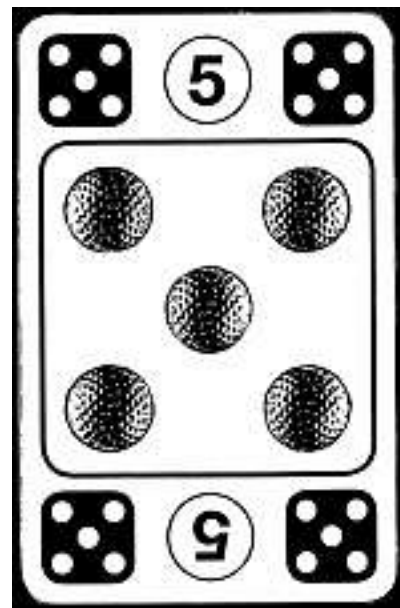

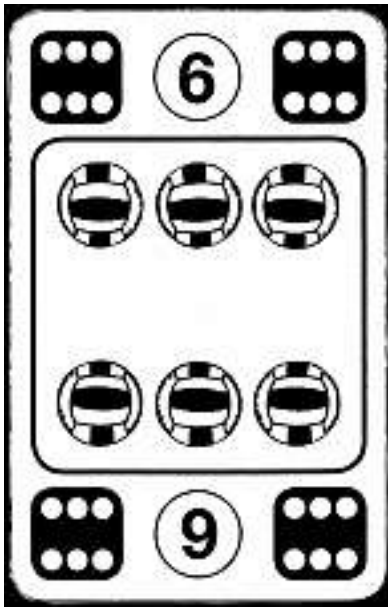

26

Cl. 24-02 **131 853** 18.05.2005
 1 Design – Therapiegerät
 Hinterleger: SwiTech Medical AG, Nationalstrasse 6,
 Postfach 2163, 8280 Kreuzlingen 1
 Designer: Wolfgang K. Meyer-Hayoz, Konstanz

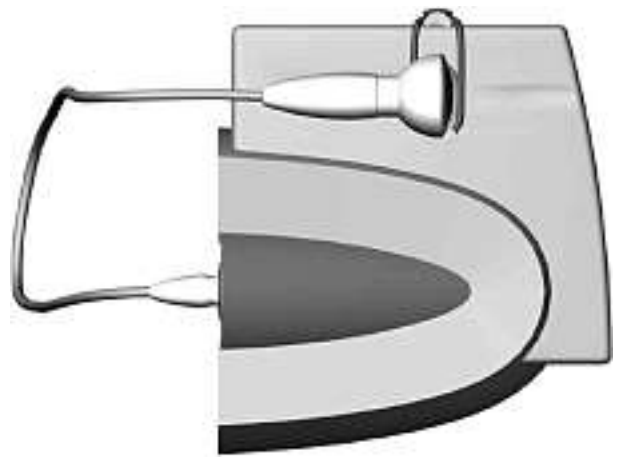
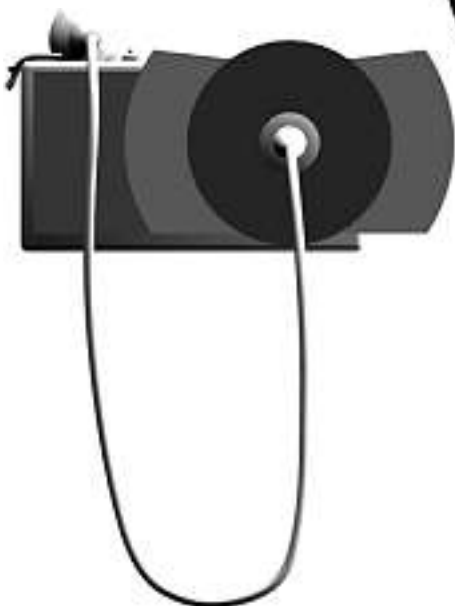

EVO01

Cl. 24-04 **131 854** 18.05.2005
 2 Design – Implantat
 Hinterleger: Acrostak Corp., Stegackerstrasse 14,
 8409 Winterthur
 Designer: Youri Popowski, Genf; Erwin Berger, Stettfurt
 Vertreter: Wolfgang Weiss, 8447 Dachsen



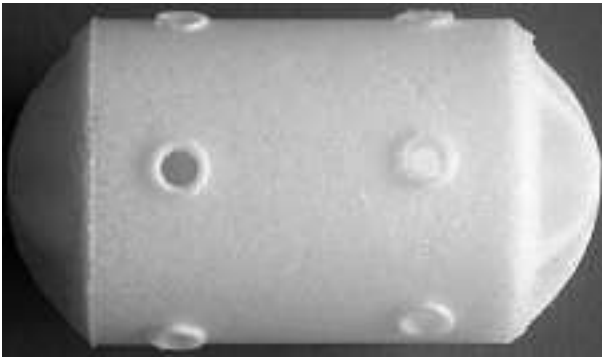

ACR001Des Implantat/1



ACR001Des Implantat/2

Cl. 24-99 131 855 06.05.2005
 1 Design – Hörgerät
 Hinterleger: Shure Acquisition Holdings, Inc.,
 5800 West Touhy Avenue, Niles/IL, US
 Designer: Gary Lester Sabick, Schaumburg; Gabor Zaroni,
 Boston; Scott Edward Stropkay, Carlisle; Jed Lowry,
 Duxbury; John Paul Devlin, Tewksbury
 Vertreter: E. Blum & Co., 8044 Zürich
 Priorität: US, 09.11.2004

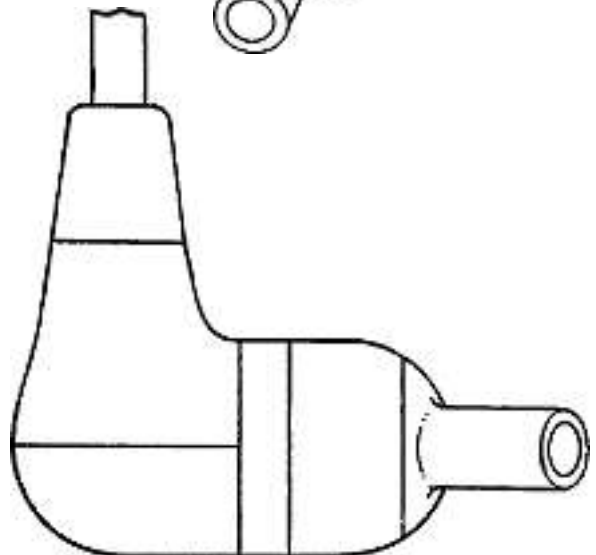
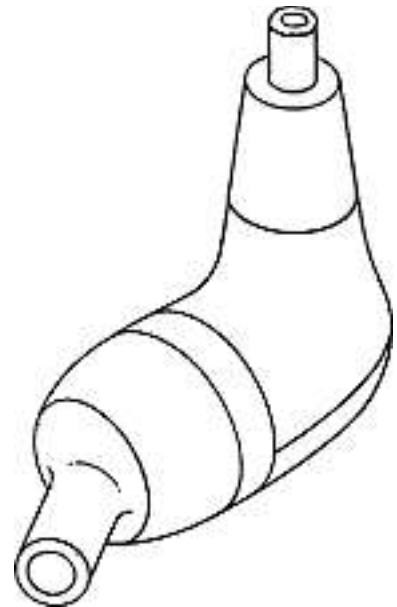
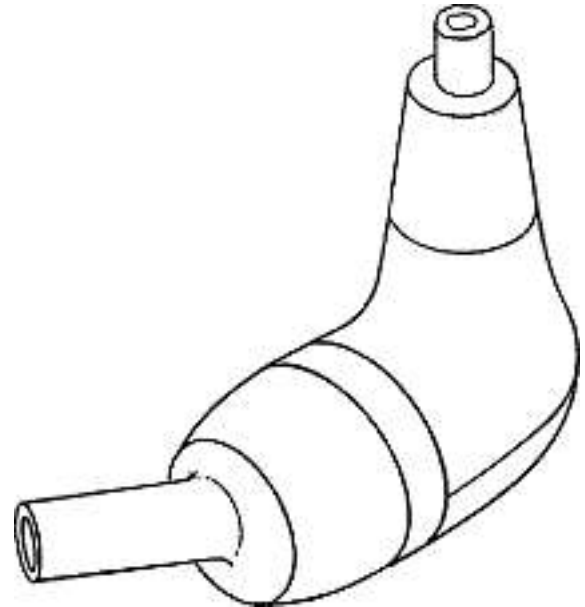

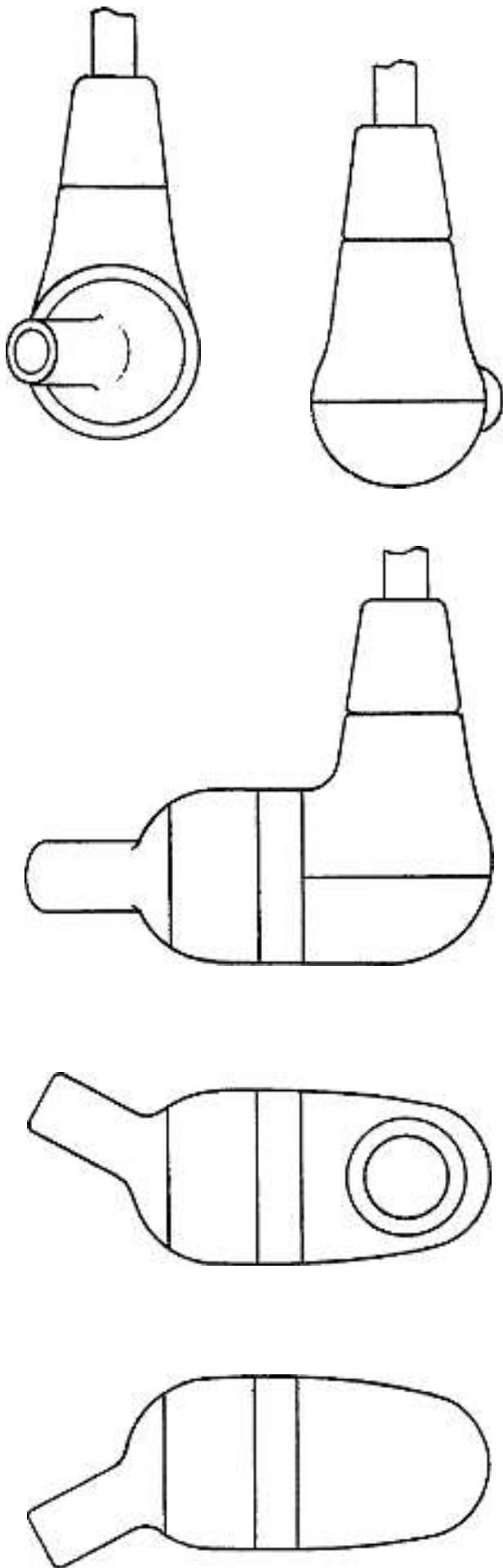

1

Cl. 25-01 131 856 18.05.2005
8 Design – Kunststein
Hinterleger: Oldcastle Building Products Canada Inc., 44,
Chipman Hill, 10th Floor, Saint-John, CA
Designer: Bertin Castonguay, Magog; Marcel Thomassen,
L'Épiphanie
Vertreter: Troesch Scheidegger Werner AG, 8126 Zumikon
Priorität: CA, 18.11.2004

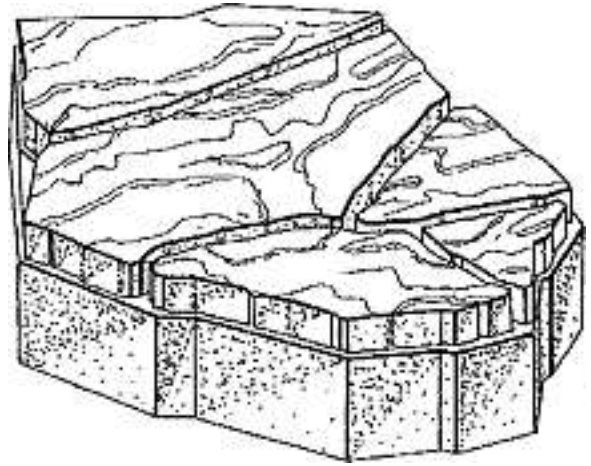

1

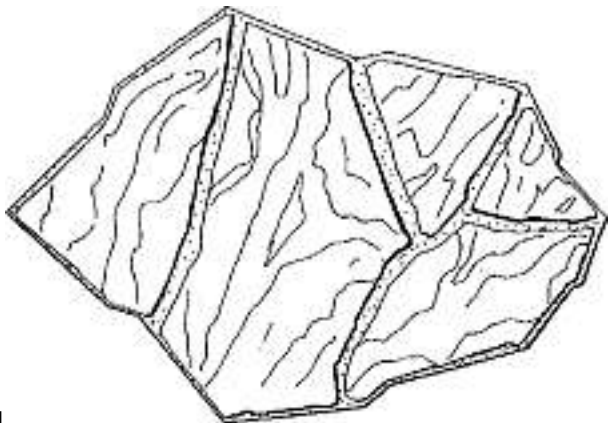

2

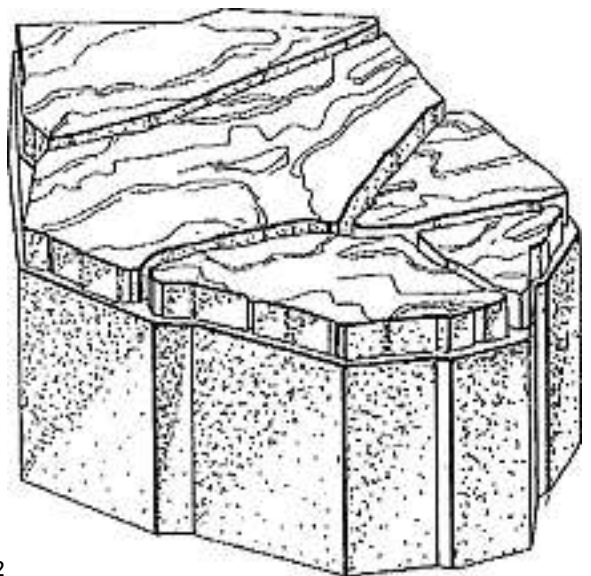

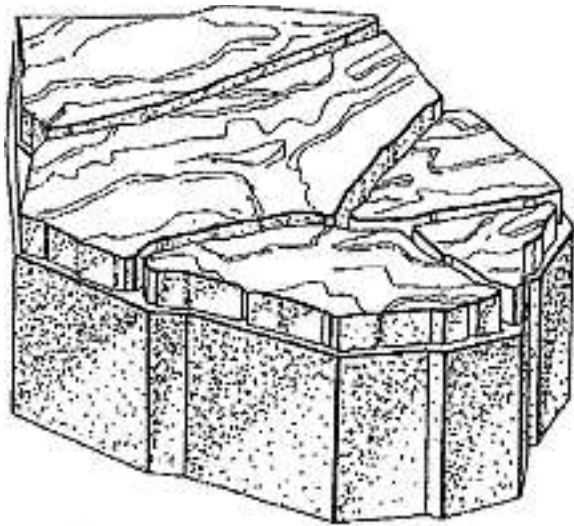

3

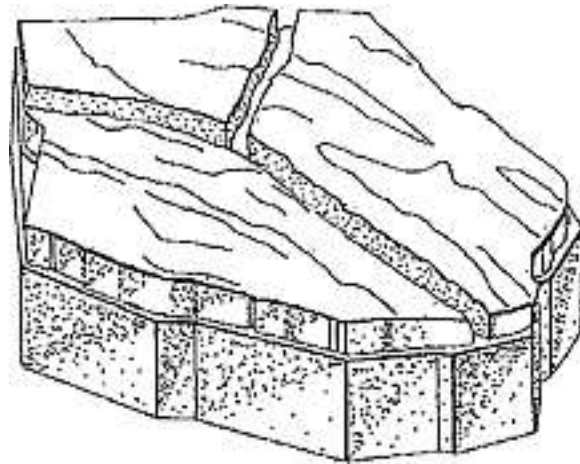

4

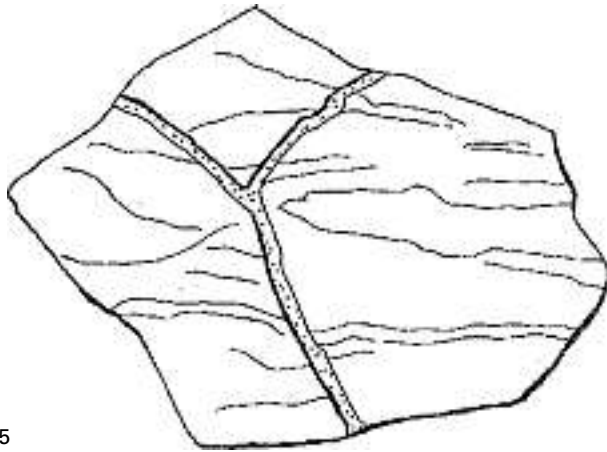

5

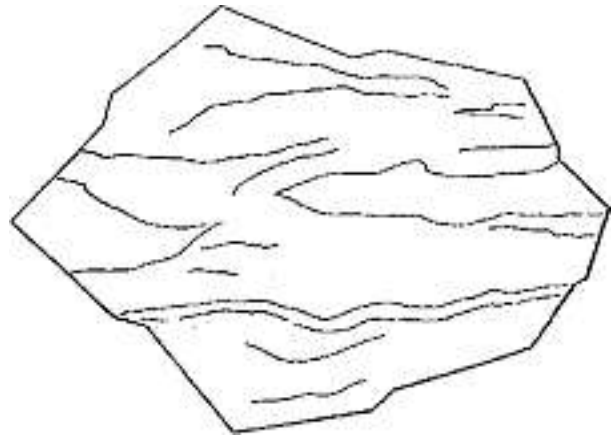
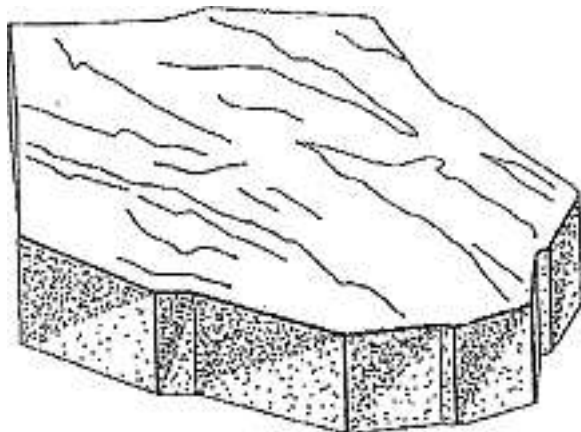

6

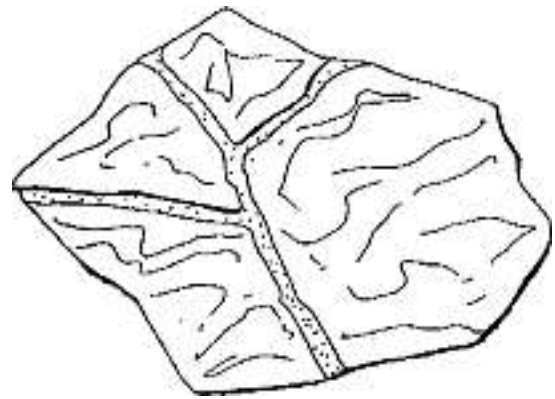

7

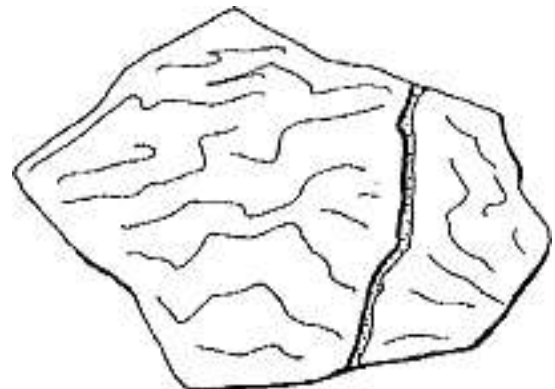

8

Cl. 25-02 **131 857** 10.05.2005
 1 Design – Strassenraumelement
 Hinterleger: Tiefbauamt des Kantons Bern,
 Oberingenieurkreis II, Schermenweg 11, 3001 Bern
 Designer: Simon Schöni, Bern; Gerhard Gerber, Bern

Cl. 25-02 **131 858** 13.05.2005
 7 Design – Schachtabdeckung
 Hinterleger: vonRoll hydrotec sa, 2830 Choindez
 Designer: Julius Kovatsch, Cham
 Vertreter: vonRoll hydrotec ag, 4702 Oensingen



str.ele.01



2650-080-3R



2650-080-4R



2650-080-5R



2650-080-6R



2650-080-10R



2650-080-7R



2650-080-8R

Cl. 25-03 **131 859** 06.05.2005
 2 Design – Windkraftturm, Windkraftturm mit Solarkraftwerk
 Hinterleger: Jozef Deak, Baumgartenstrasse 35,
 5608 Stetten AG

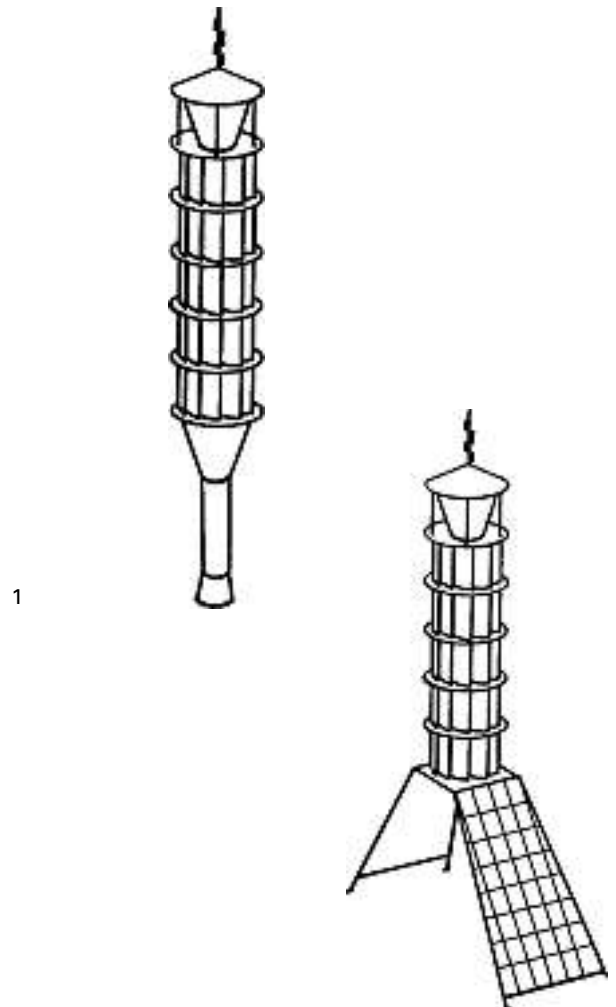

1

2

Cl. 25-03 131 860 13.05.2005
 1 Design – Lager
 Hinterleger: Jozef Deak, Baumgartenstrasse 35,
 5608 Stetten AG

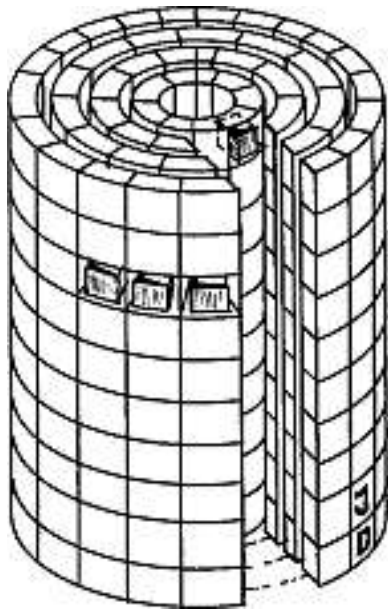

Design 1

Cl. 25-99 131 861 02.05.2005
 1 Design – Landerampe
 Hinterleger: Vivan Gantner, Seelihalde 7, 8825 Hütten;
 Ulrich Korb, Im Seeblick 7, 8825 Hütten
 Vertreter: Ulrich Korb, 8825 Hütten



Freestyle Motocross

Cl. 26-03 131 862 17.05.2005
 1 Design – Tunnel-Fluchtwegeingangsbeleuchtung
 Hinterleger: Jürg Nigg, Beckenhofstrasse 30, 8035 Zürich

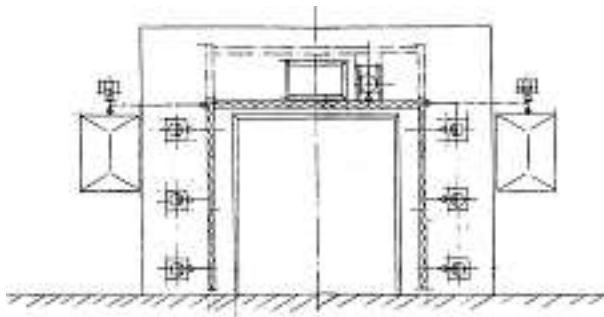

050517-1BL

Cl. 26-05 131 863 18.04.2005
 1 Design – Lampe
 Hinterleger: Michael Storck, Grenzstrasse 56, 2560 Nidau
 Designer: Michael Storck, Nidau; Maja Weil, Therwil

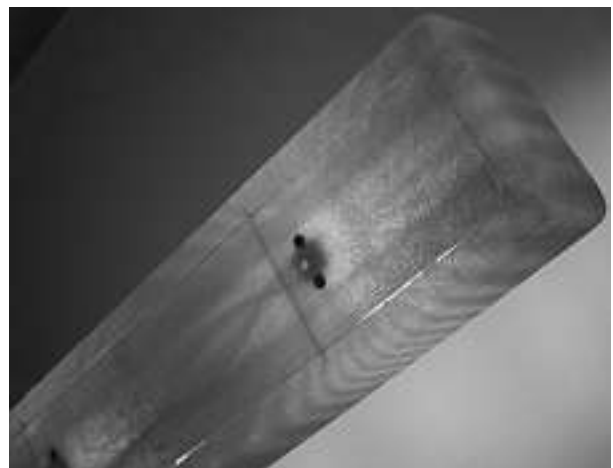
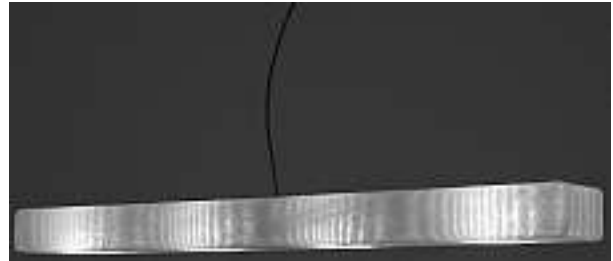

LiLu

Cl. 26-05 131 864 06.05.2005
 1 Design – Lampe
 Hinterleger: Louis Poulsen Lighting A/S, Nyhavn 11,
 Kopenhagen, DK
 Designer: Louise Campbell, Kopenhagen
 Vertreter: Isler & Pedrazzini AG, 8023 Zürich
 Priorität: DK, 02.05.2005

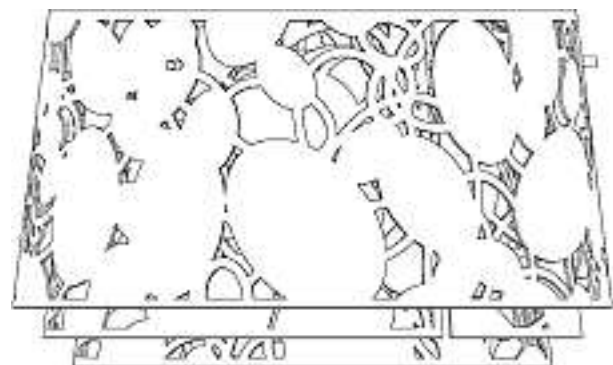

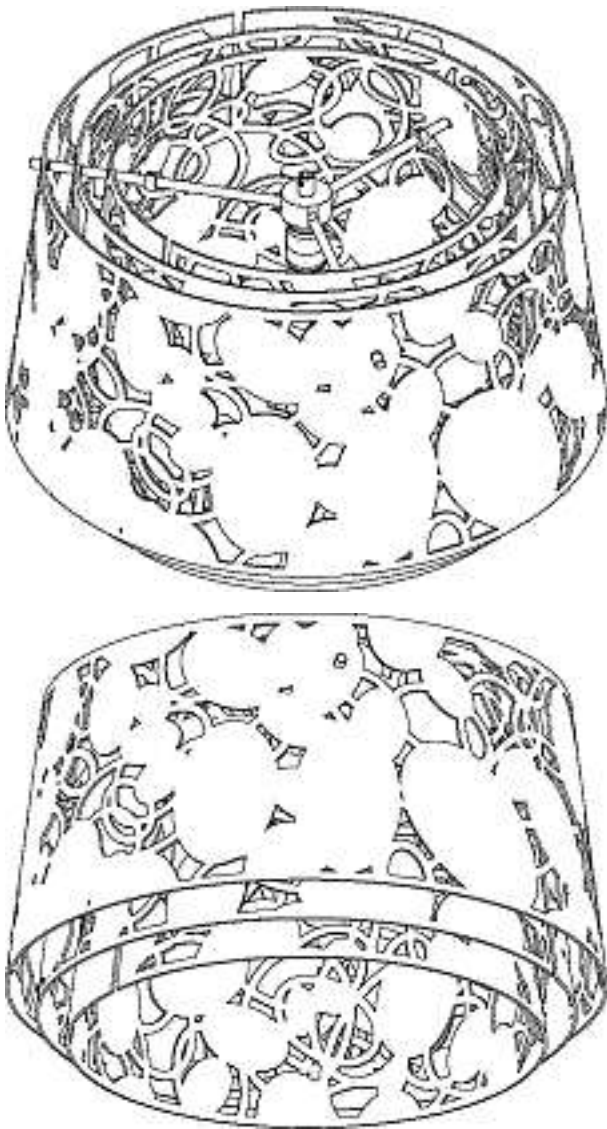

M13030

Cl. 99-00 131 865 18.05.2005
 2 Design - Urne
 Hinterleger: mass-massenware schär & co,
 Schwandenholzstrasse 186 A, 8046 Zürich
 Designer: Thomas Schär, Zürich



sfera rossa



etoile blanche

**Verlängerungen
Prolongations
Prolongazioni**

118 164 Cl. 03-01 1 Design



1

118 259 Cl. 09-03 1 design

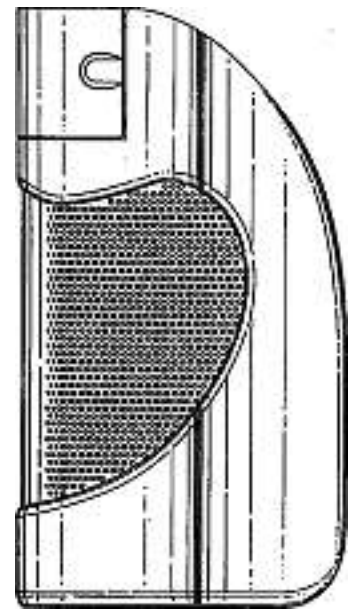
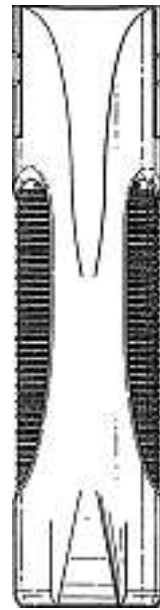
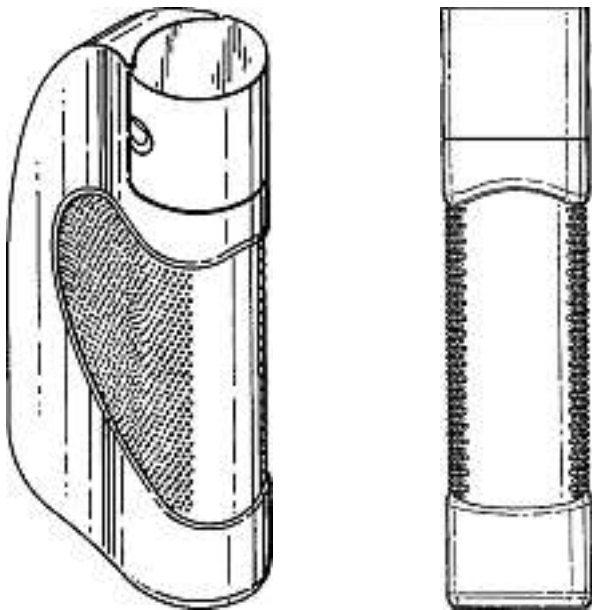

1

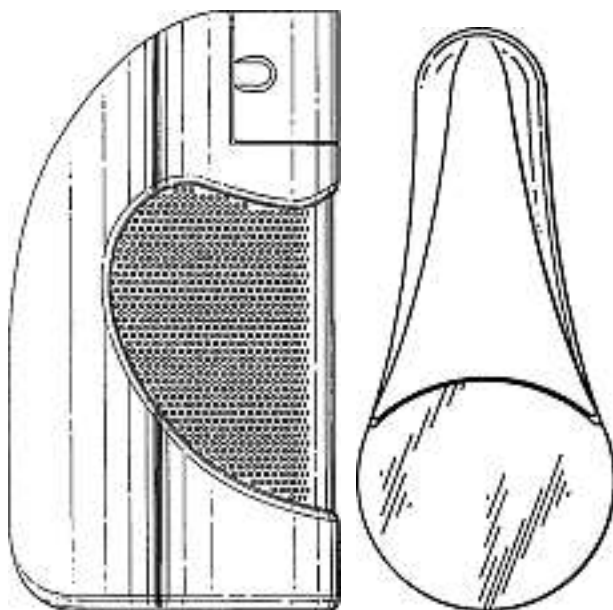
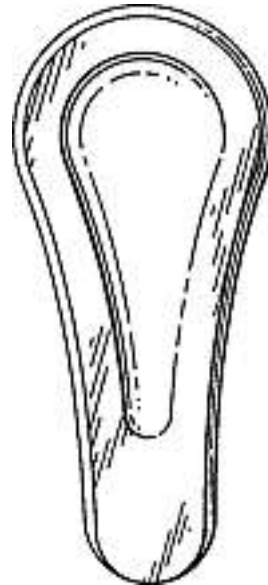

118 338	Cl.	10-02	1 Design
122 425	Cl.	26-05	1 Design
122 426	Cl.	01-01	1 Design
122 444	Cl.	10-07	1 design
122 454	Cl.	14-99	8 Design
122 469	Cl.	29-02	1 Design
122 470	Cl.	03-01	1 Design
122 473	Cl.	06-01	4 Design
122 516	Cl.	07-06	1 Design
122 600	Cl.	09-01	1 Design
122 710	Cl.	12-11	1 Design
122 935	Cl.	23-02	1 Design
126 936	Cl.	07-01	1 Design
127 115	Cl.	08-05	10 Design
127 136	Cl.	06-01	1 Design
127 196	Cl.	14-02	2 Design
127 216	Cl.	09-05	2 Design
127 241	Cl.	02-07	1 Design
127 345	Cl.	25-03	1 Design
127 357	Cl.	06-03	1 Design
127 393	Cl.	20-03	3 design
127 396	Cl.	21-01	1 Design
127 414	Cl.	07-02	1 design
127 438	Cl.	19-08	1 Design
127 459	Cl.	06-07	1 Design
128 064	Cl.	15-99	1 Design

Mutationen
Modifications
Modificazioni

118 021

Übertragung
 Hinterleger: Hüsler Nest Holding AG,
 c/o ALLconsult Services Armin L. Landtwing,
 Industriestrasse 24, 6300 Zug

120 985**120 986****122 197****125 076****126 120****130 577**

Namensänderung
 Hinterleger: Siemens Schweiz AG, Albisriederstrasse 245,
 8047 Zürich
 Vertreter: Siemens Schweiz AG, 6300 Zug

121 442

Namensänderung
 Hinterleger: Stokke AS, Hahjem, 6260 Skodje, NO

127 233

Namensänderung
 Hinterleger: Hydraulic Engineering Holding S.A., 23, Avenue
 Monterey, Luxembourg, LU

131 676

Übertragung
 Hinterleger: Ionic Production AG, Schützenmatte 10,
 6362 Stansstad

Löschungen
Radiations
Radiazioni

117 862	Cl.	10-02	1 Design
121 917	Cl.	06-01	1 Design
121 924	Cl.	06-08	1 Design
121 931	Cl.	09-05	2 design
121 938	Cl.	10-07	1 design
121 947	Cl.	23-01	1 Design
121 974	Cl.	19-06	4 Design
121 984	Cl.	21-02	1 Design
126 558	Cl.	05-05	2 Design
126 562	Cl.	06-03	2 Design
126 598	Cl.	06-03	1 Design
126 599	Cl.	06-04	22 Design
126 600	Cl.	07-01	2 Design
126 601	Cl.	07-06	1 Design
126 602	Cl.	07-99	1 Design
126 607	Cl.	10-07	1 Design
126 608	Cl.	11-01	1 Design
126 609	Cl.	11-01	3 design
126 610	Cl.	14-03	1 Design
126 613	Cl.	19-08	1 Design
126 617	Cl.	23-03	1 design
126 621	Cl.	28-03	1 design
126 624	Cl.	06-01	2 Design
126 654	Cl.	16-01	1 design
126 684	Cl.	10-02	1 design
126 685	Cl.	10-02	1 design
126 709	Cl.	06-04	1 design