

Nationale Hinterlegungen

In der folgenden Liste werden die beim Eidgenössischen Institut für Geistiges Eigentum hinterlegten Designs publiziert. Dabei sind der Reihe nach angegeben:

- internationale Klassenangaben
- Hinterlegungsnummer
- Hinterlegungsdatum
- Allenfalls Aufschub der Veröffentlichung
- Anzahl der hinterlegten Designs
- Bezeichnung
- Name und Wohnsitz des Hinterlegers oder der Hinterlegerin
- gegebenenfalls Name und Wohnsitz des Designers oder der Designerin
- Name und Geschäftssitz des allfälligen Vertreters oder der Vertreterin
- gegebenenfalls Prioritätsangaben
- gegebenenfalls Beschreibungstext
- Ordnungsnummer
- Reproduktion des Designs

Internationale Hinterlegungen

Die bei der Weltorganisation für geistiges Eigentum in Genf hinterlegten Muster und Modelle mit Benennung Schweiz geniessen den gleichen Schutz wie national hinterlegte Designs. Sie werden jeweils im Blatt «Bulletin des dessins et modèles internationaux» veröffentlicht. Dieses Publikationsorgan ist deshalb für eine vollständige Recherche unbedingt beizuziehen.

Topographien

Angaben über die vom Eidgenössischen Institut für Geistiges Eigentum eingetragenen Topographien von Halbleitererzeugnissen werden in folgender Anordnung aufgeführt:

- Eintragsnummer
- Anmeldedatum
- Bezeichnung
- Name und Wohnsitz des Anmelders oder der Anmelderin
- gegebenenfalls Name und Wohnsitz des Herstellers oder der Herstellerin
- Name und Geschäftssitz des oder der allfälligen Bevollmächtigten
- Datum und Ort einer allfälligen ersten geschäftlichen Verbreitung der Topographie

Dépôts nationaux

Les designs déposés à l'Institut Fédéral de la Propriété Intellectuelle sont publiés dans la liste qui suit. Les indications y relatives sont mentionnées dans cet ordre:

- indications des classes internationales
- numéro de dépôt
- date de dépôt
- le cas échéant, ajournement de la publication
- nombre des designs déposés
- désignation
- nom et domicile du/de la déposant/e
- le cas échéant, nom et domicile du/de la designer
- nom et domicile de l'éventuel/le mandataire
- le cas échéant, indication de priorité
- le cas échéant, description du design
- numéro attribué à chaque design
- reproduction du design

Dépôts internationaux

Les dessins et modèles déposés à l'Organisation Mondiale de la Propriété Intellectuelle à Genève qui désignent la Suisse jouissent de la même protection que les dépôts nationaux. Ils sont chaque fois publiés dans la feuille «Bulletin des dessins et modèles internationaux». Pour une recherche complète, il est indispensable de consulter ledit organe de publication.

Topographies

Les indications concernant les topographies des produits semi-conducteurs, enregistrées par l'Institut Fédéral de la Propriété Intellectuelle, sont énumérées dans l'ordre suivant:

- numéro d'enregistrement
- date de dépôt
- désignation
- nom et domicile du/de la déposant/e
- le cas échéant, nom et domicile du/de la producteur/trice
- nom et domicile de l'éventuel/le mandataire
- date et lieu d'une éventuelle première mise en circulation de la topographie

Depositi nazionali

Nella lista seguente vengono pubblicati i design depositati presso l'Istituto Federale della Proprietà Intellettuale. Sono menzionati nel seguente ordine:

- indicazioni delle classi internazionali
- numero di deposito
- data del deposito
- se del caso, indicazione che la pubblicazione è stata differita
- numero dei design depositati
- designazione
- nome e domicilio del depositante
- se del caso, nome e domicilio del designer
- nome e sede di un eventuale mandataro
- se del caso, indicazioni di priorità
- se del caso, descrizione del design
- numero d'ordine
- riproduzione del design

Depositi internazionali

I disegni e modelli depositati presso l'Organizzazione Mondiale della Proprietà Intellettuale a Ginevra con denominazione Svizzera godono della medesima protezione del deposito nazionale. Essi vengono pubblicati ogni volta nel foglio «Bulletin des dessins et modèles internationaux». Quest'organo di pubblicazione è da consultare se si vuole effettuare una ricerca completa.

Topografie

Le indicazioni concernenti le topografie di prodotti a semiconduttori depositati presso l'Istituto Federale della Proprietà Intellettuale sono menzionate nell'ordine seguente:

- numero di registrazione
- data del deposito
- designazione
- nome e domicilio del/la richiedente
- se del caso, nome e domicilio del/la produttore/trice
- nome e sede di un eventuale mandataro
- data e luogo di un'eventuale prima messa in circolazione della topografia

Hinterlegungen
Dépôts
Deposit

Cl. 19-06 **129 114** 01.11.2002
 4 design – stylo-bille et porte-plume
 Déposant: Richemont Italia SpA, Via Ludovico di Breme 44,
 Milano, IT
 Designer: Giampiero Bodino, Milano
 Mandataire: Micheli & Cie, 1226 Thônex (Genève)
 Fin de la période ajournement de la publication

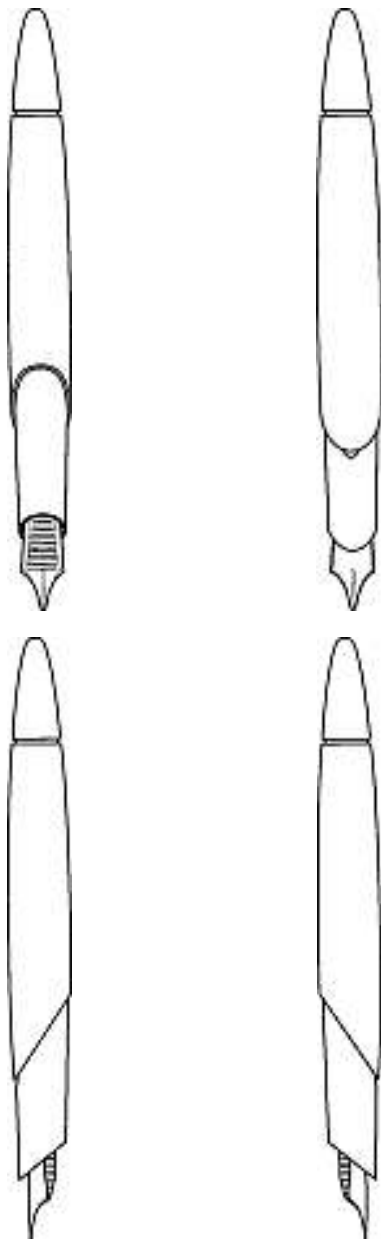

13839A

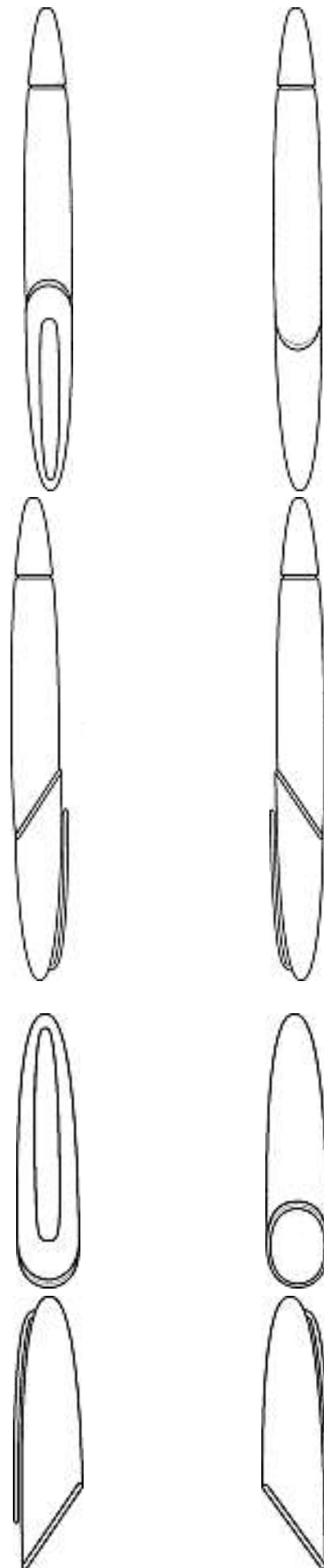

13839B

13839C

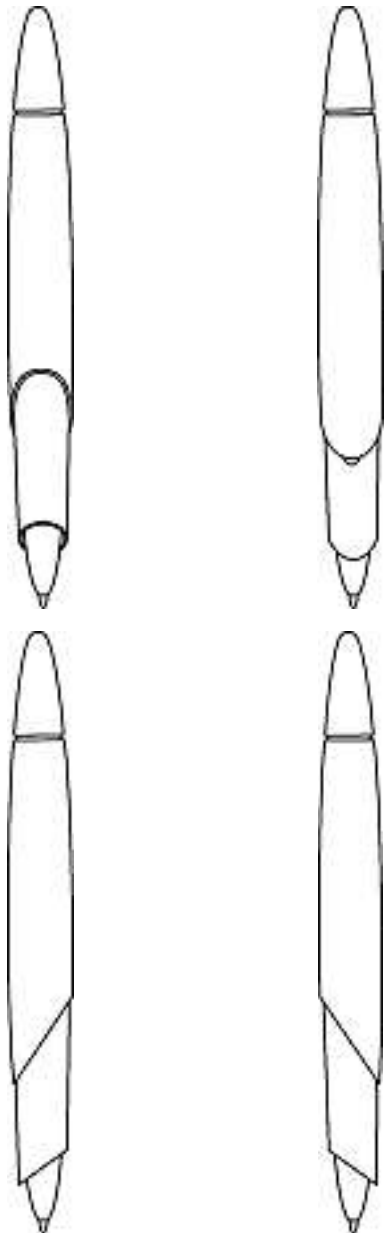

13839D

Cl. 23-03 **129 117** 13.11.2002
 1 design – brûleur et ses parties constitutives
 Déposant: Redi, Rue du Vidollet 5, 1202 Genève
 Mandataire: Micheli & Cie, 1226 Thônex (Genève)
 Fin de la période ajournement de la publication



13833-SUISSE

Cl. 05-05 **129 167** 26.11.2002
 1 Design – Textilmuster
 Hinterleger: Roman Lorenc, Seestrasse 318, 8038 Zürich
 Ende aufgeschobene Publikation

No. 1 (siehe Farbteil Heftmitte)

Cl. 14-99 **129 432** 04.04.2003
 3 Design – Computerbildschirm-Halter
 Hinterleger: Ernst Maurer, Höh, 3615 Heimenschwand
 Vertreter: Bovard AG, 3000 Bern 25
 Ende aufgeschobene Publikation

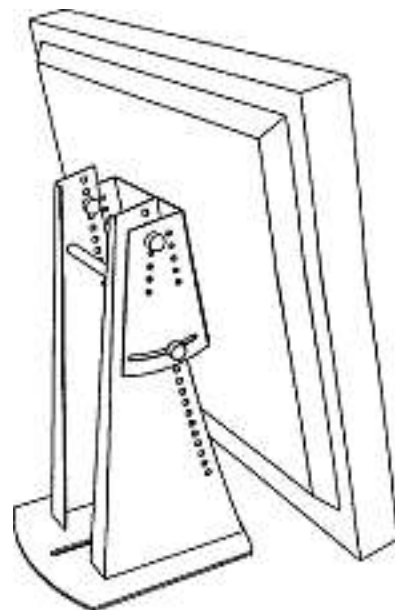

300324 (1)

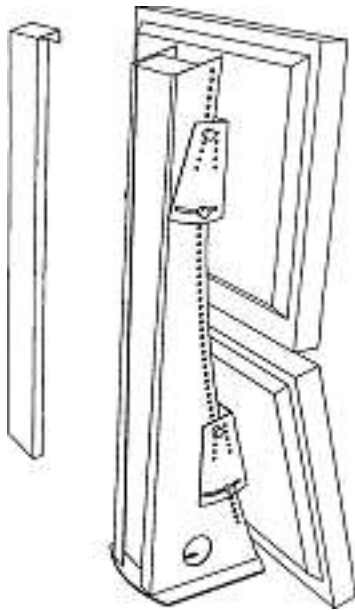

300324 (2)

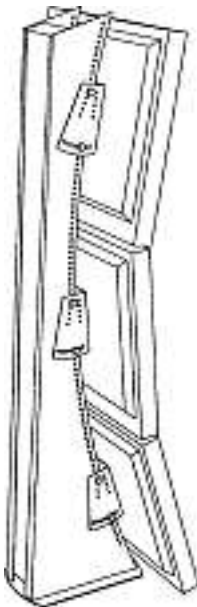

300324 (3)

Cl. 01-01 **131 494** 14.03.2005
 1 Design – Gebäck
 Hinterleger: Christoph Lanter, Rosenstrasse 3,
 8570 Weinfelden
 Vertreter: Isler & Pedrazzini AG, 8023 Zürich

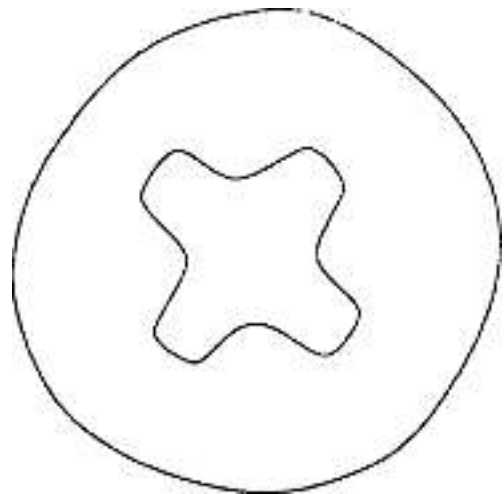
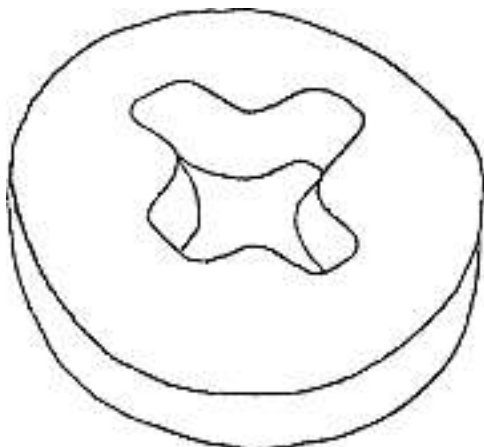

M13013

Cl. 01-03 **131 495** 03.02.2005
 1 Design – Käse
 Hinterleger: Schaukäserei Schwyzerland, Milchstrasse,
 6423 Seewen SZ
 Designer: Josef Reichmuth, Seewen SZ
 Vertreter: Lenz & Staehelin, Rechtsanwälte, 8027 Zürich



0650-DES/CH

Cl. 01-03 **131 496** 03.02.2005
 1 Design – Käse
 Hinterleger: Schaukäserei Schwyzerland, Milchstrasse,
 6423 Seewen SZ
 Designer: Josef Reichmuth, Seewen SZ
 Vertreter: Lenz & Staehelin, Rechtsanwälte, 8027 Zürich



0651-DES/CH

Cl. 02-01 **131 497** 02.02.2005
 4 Design – Nierenschutz
 Hinterleger: Stephanie Cekon, Bahnhofstrasse 44, 7000 Chur;
 Alexandra Christensen, St. Gallerstrasse 56, 8853 Lachen
 Vertreter: Stephanie Cekon, 7000 Chur



1



2



3



4

Cl. 02-02 131 498 02.03.2005
 2 Design – Gesässtaschen
 Hinterleger: TOM TAILOR AG, Garstedter Weg 14,
 Hamburg, DE
 Designer: Oliver Schröder, Hamburg
 Vertreter: Schmauder & Partner AG, Patentanwälte VSP,
 8038 Zürich

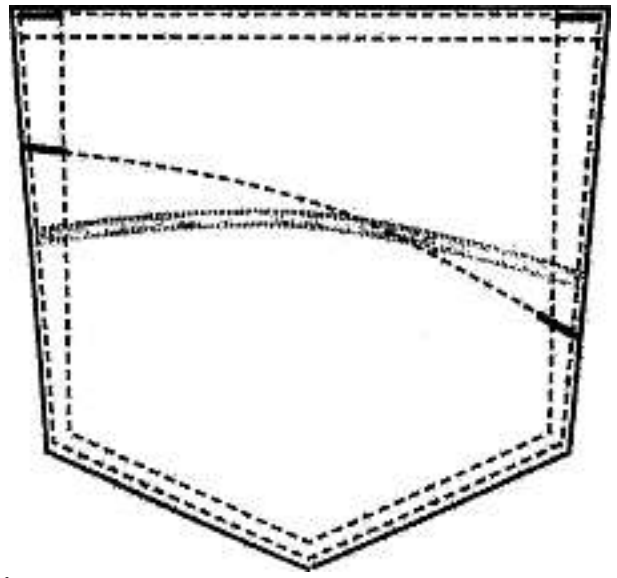

1

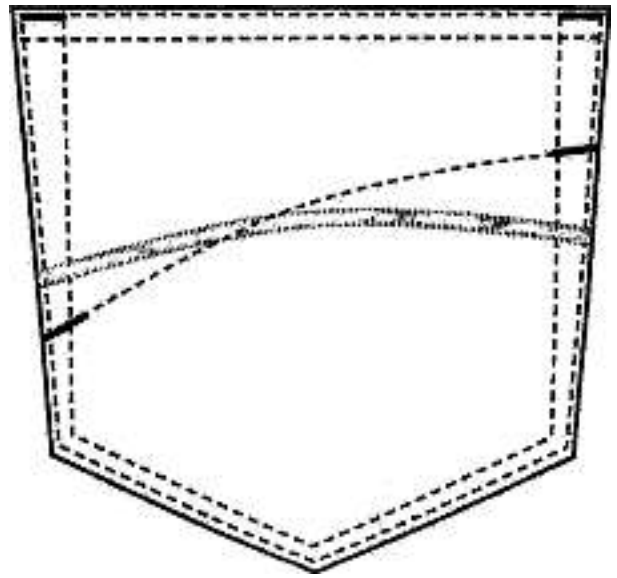

2

Cl. 02-07 131 499 14.02.2005
 1 Design – Gürtel für Datenverarbeitungsgeräte
 Hinterleger: ETH Zürich, ETH Transfer, Rämistrasse 101,
 8092 Zürich
 Designer: Stijn Ossevoort, Zürich





QBIC002

Cl. 02-07 131 500 21.02.2005

2 Design – Halsschleifen-Halter

Hinterleger: LA LOOP LLC, Suite 203A, 33 Little West
12th Street, New York, NY, USDesigner: Deborah A. Zoullas, New York; Elizabeth Faraut,
New York

Vertreter: Walder Wyss & Partner, 8022 Zürich

Priorität: US, 23.11.2004; US, 23.11.2004



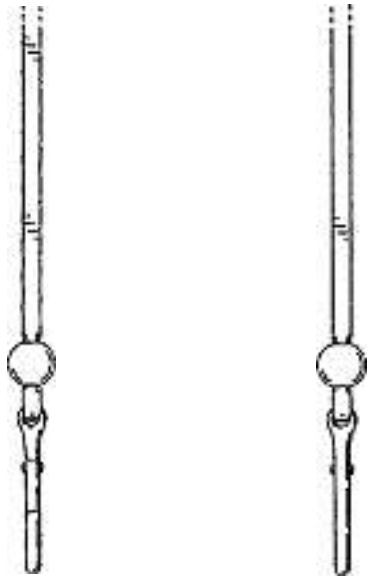
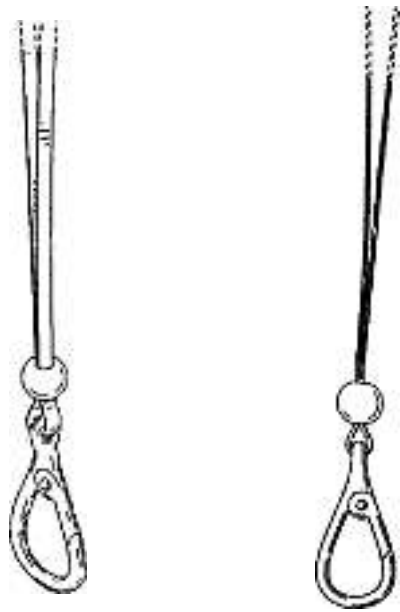

2202.013 CH a



2202.013 CH b

Cl. 03-01 131 501 01.02.2005
2 Design – Taschen
Hinterleger: Stephan Müller, Säntisstrasse 45,
8200 Schaffhausen
Vertreter: Felber & Partner AG, 8034 Zürich





mul 1 DCH/1



mul 1 DCH/2

Cl. 03-01 131 502 07.02.2005
6 design – sacs, poches
Déposant: Colette Schenk-Courvoisier, rue du Simplon 7,
1006 Lausanne



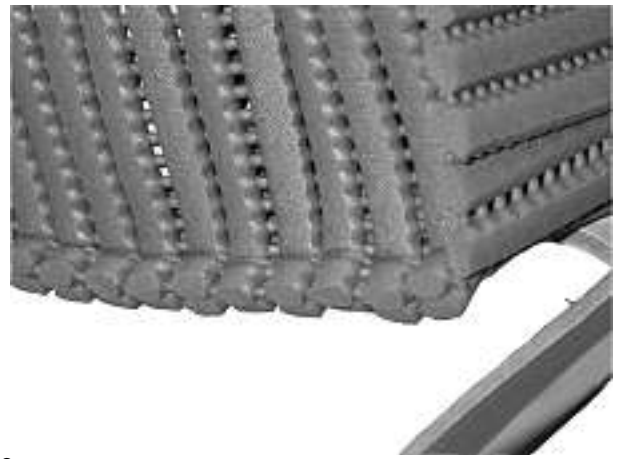

3



2



4



5



6

Cl. 04-02 **131 503** 22.03.2005
 4 Design – Zahnbürste, Zahnbürsten-Borstenmuster und
 Zahnbürstenstiele
 Hinterleger: Colgate-Palmolive Company, 909 River Road,
 P.O. Box 1343, Piscataway, NJ, US
 Designer: Douglas J. Hohlbein, Pennington
 Vertreter: E. Blum & Co., 8044 Zürich
 Priorität: US, 23.09.2004

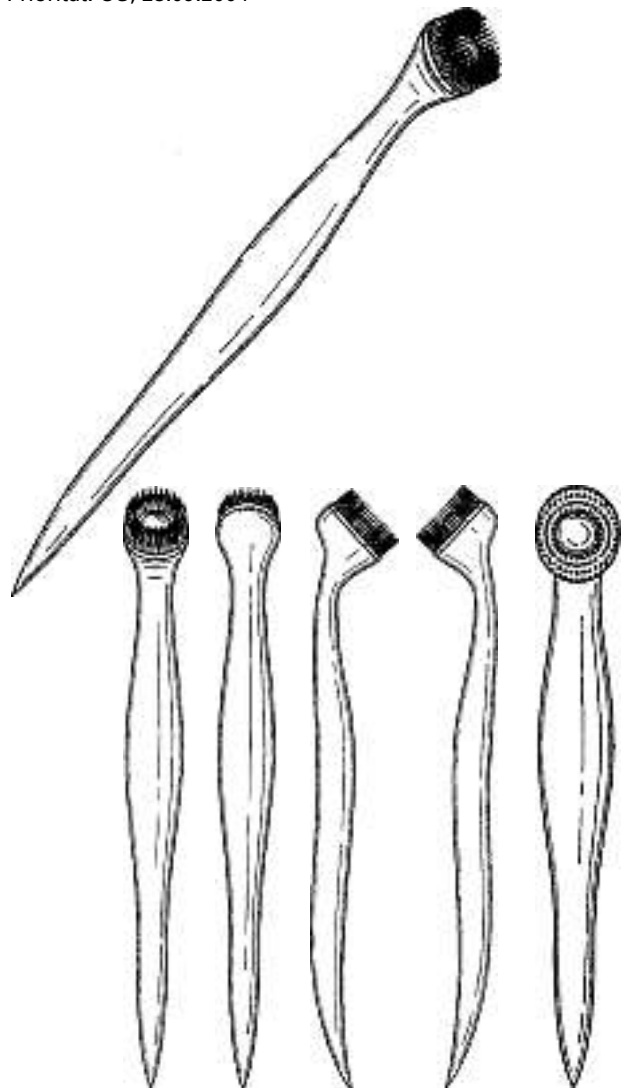

A-2005/1014a



A-2005/1014b

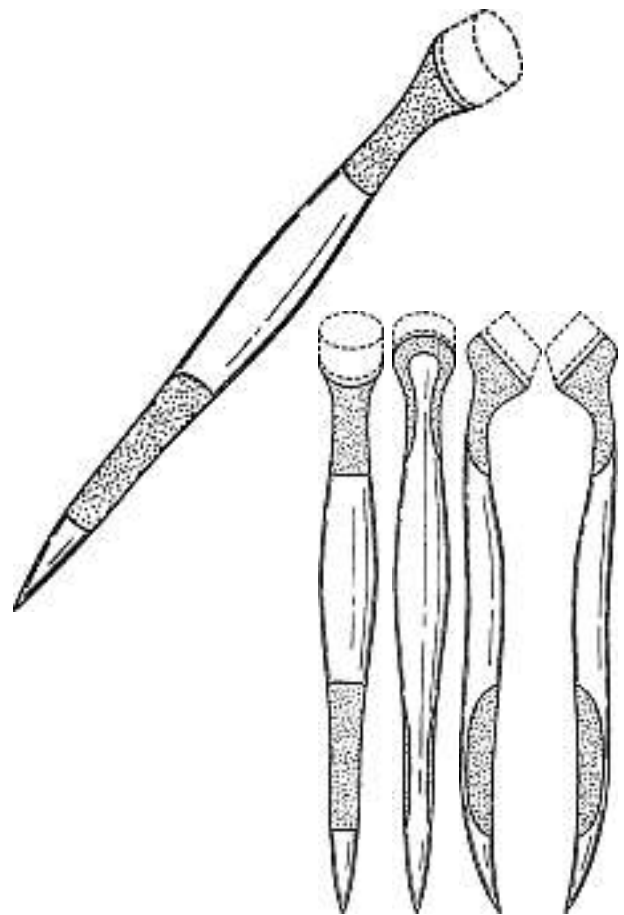

A-2005/1014d

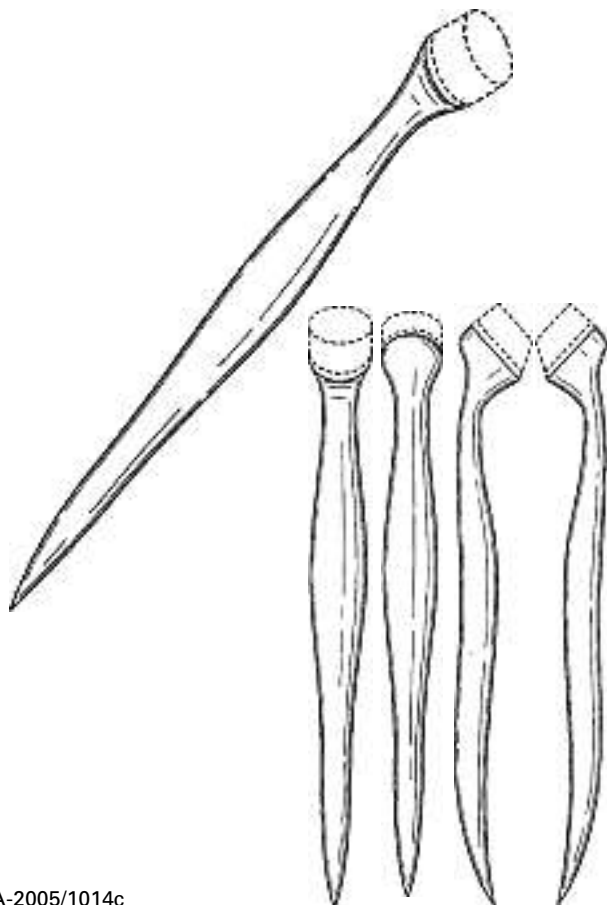

A-2005/1014c

Cl. 04-04 **131 504** 14.02.2005
4 Design – Pinselgriffe, Pinsel
Hinterleger: SWISSINNO SOLUTIONS GmbH,
Rosenbergstrasse 22, 9000 St. Gallen
Designer: Gabriel Le Laidier, St. Gallen



01 Innobrush Holz-Pinselgriff

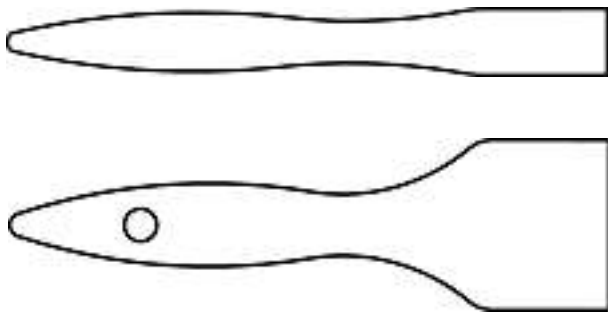

02 X-Change Pinselgriff



03 Innobrush Effekt-Wischer



04 Innobrush Struktur-Wischer

Cl. 06-01, 06-03 **131 505** 08.02.2005
 8 Design – Polstermöbel, Sessel, Tisch
 Hinterleger: Rolf Benz AG & Co. KG,
 Haiterbacher Strasse 104, 72202 Nagold, DE
 Designer: Norbert Beck, Markdorf; Christian Werner,
 Hollenstedt/Appel; Cuno Frommherz, Burgdorf; Klaus Bergen,
 Orselina; Anke Reuter, Stuttgart; Edgar Reuter, Donzdorf
 Vertreter: Bovard AG, 3000 Bern 25
 Priorität: EM, 14.09.2004



1



2







4



5





6





7



8

Cl. 06-01 131 506 09.02.2005
2 Design – Schaukel-Liege
Hinterleger: Micheline Hauchecorne, Insstrasse 15 B,
3237 Brüttelen

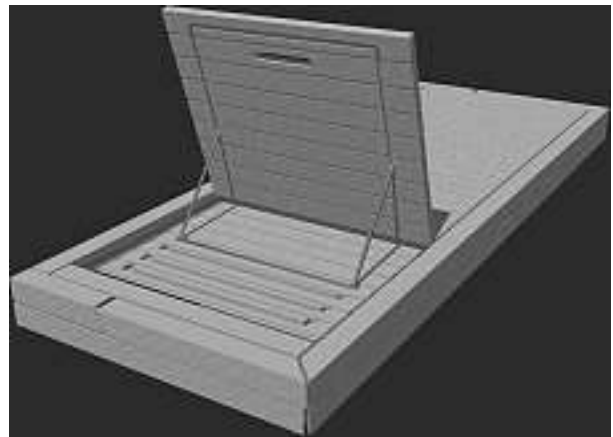
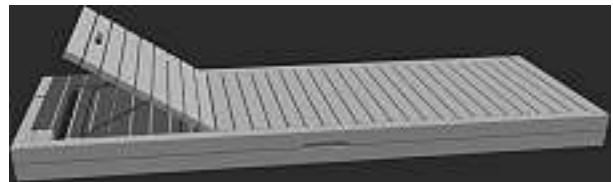

Hang On 1

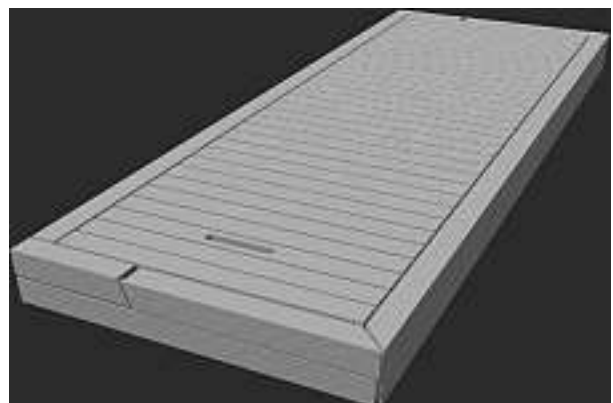

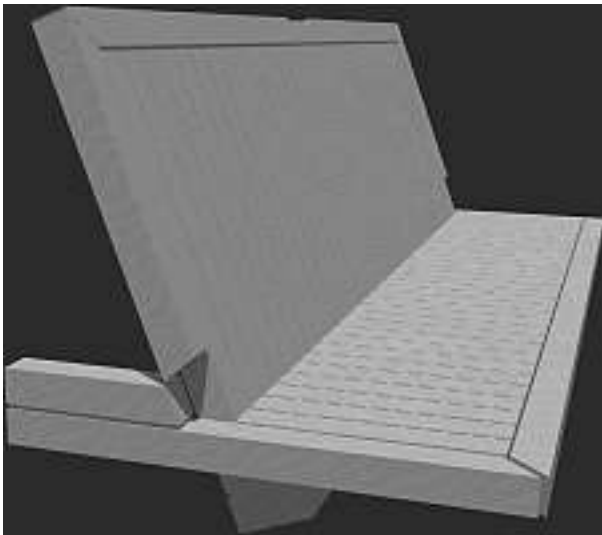

Hang On 2

Cl. 06-03 **131 507** 02.02.2005
 1 Design – Tisch
 Hinterleger: Spallo Kolb, Viscose 65, 9443 Widnau



001 t_profil

Cl. 07-02 **131 509** 04.02.2005
 1 Design – Kaffee-Hersteller
 Hinterleger: PI-DESIGN AG, Kantonsstrasse 100,
 6234 Triengen
 Designer: Jorgen Bodum, St. Niklausen
 Vertreter: Isler & Pedrazzini AG, 8023 Zürich
 Priorität: DK, 13.08.2004





M12984

Cl. 07-02 **131 510** 15.03.2005
 2 Design – Griffe für Kochgeschirr
 Hinterleger: TVS S.p.A, Località Trasanni 100,
 61020 Trasanni-Urbino, IT
 Designer: Iside Scipioni, Pesaro
 Vertreter: E. Blum & Co., 8044 Zürich
 Priorität: IT, 30.12.2004

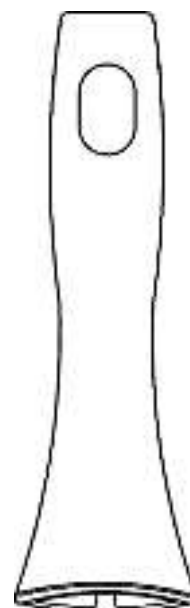
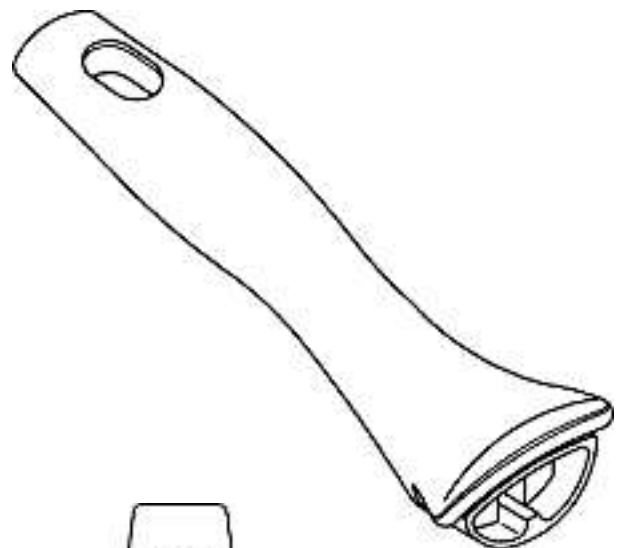

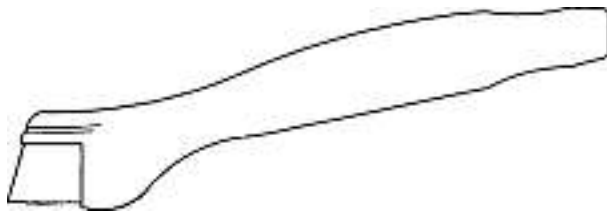
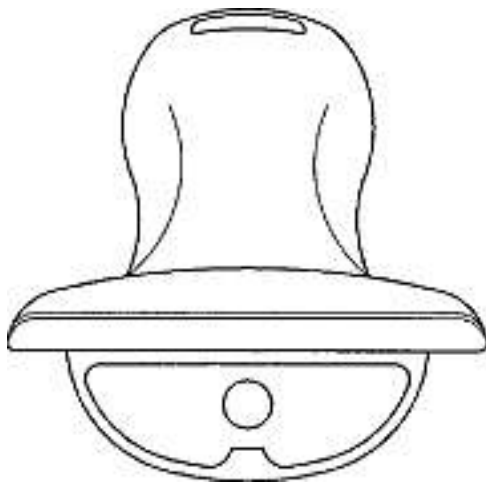

A-2005/1012a

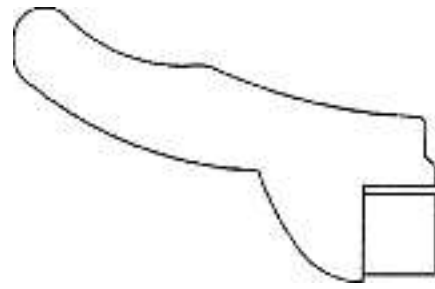
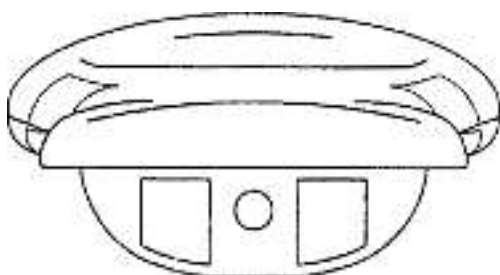

A-2005/1012b

Cl. 07-03 **131 511** 04.02.2005
 3 Design – Messer, Gabel, Löffel
 Hinterleger: M. H. Wilkens & Söhne GmbH,
 An der Silberpräge, Bremen, DE
 Designer: Claudia Christl, Bremen
 Vertreter: Isler & Pedrazzini AG, 8023 Zürich



M12997-1



M12997-2



M12997-3

Cl. 07-06 **131 512** 09.02.2005
 1 design – tire-bouchons
 Déposant: Pierre Vuille, Rue de Dessous 9, 2207 Coffrane





Pierry001

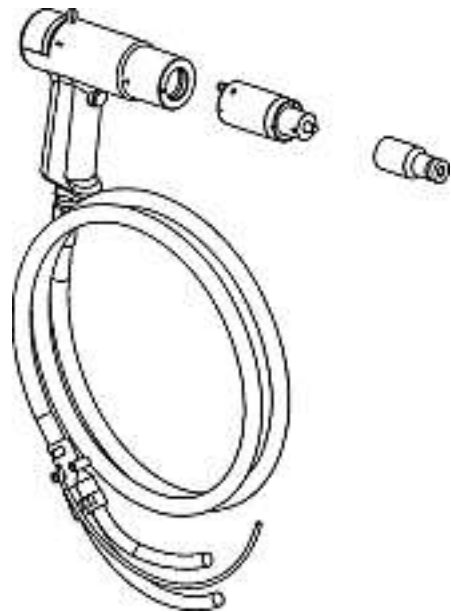

B



C

Cl. 08-05 **131 513** 31.01.2005
 3 Design – Handschweissgerät
 Hinterleger: Rinco Holding AG, Industriestrasse 4,
 8590 Romanshorn
 Designer: Andreas Beer, Bernhardzell
 Vertreter: Wild Schnyder AG, 8032 Zürich



A

Cl. 08-06 **131 514** 14.01.2005
 5 Design – Tür- und Fenstergriffe
 Hinterleger: HOPPE AG, Am Plausdorfer Tor 13,
 Stadtallendorf, DE
 Designer: Horst Paflla, Stadtallendorf; Reinhard Runge,
 Hallenberg
 Vertreter: PA Aldo Römpler, 9410 Heiden
 Priorität: EM, 12.11.2004

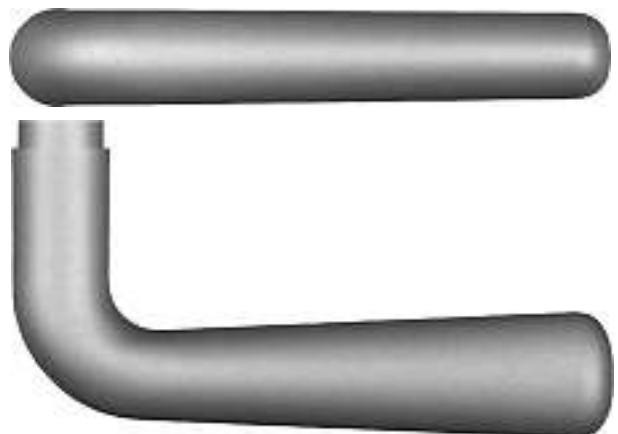

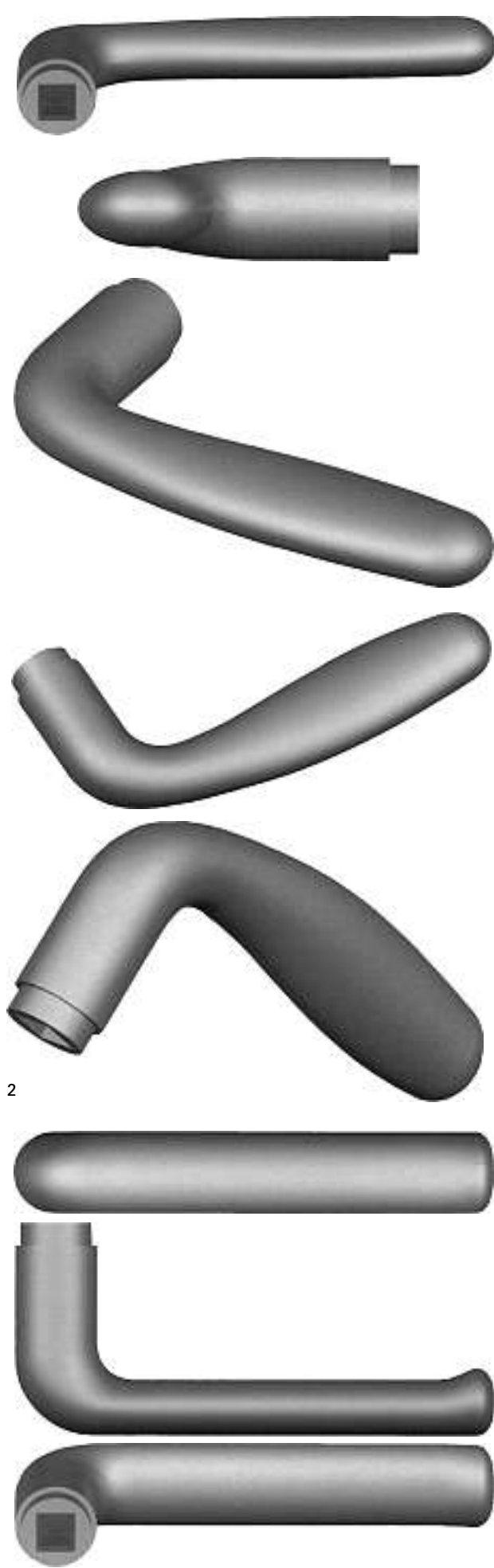
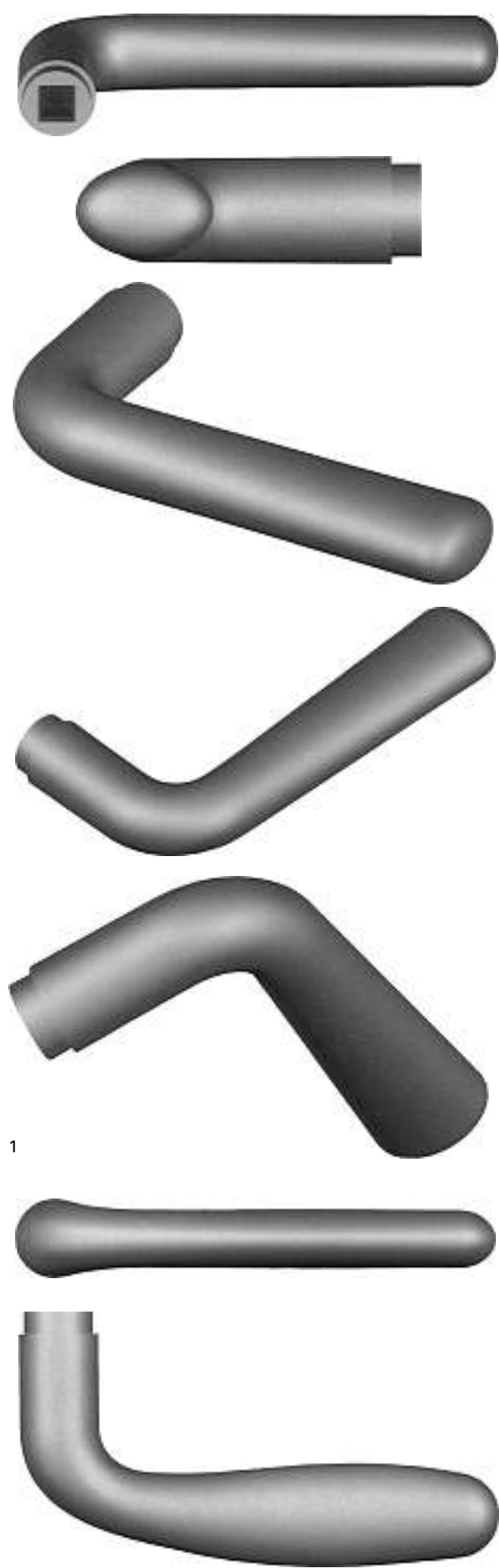

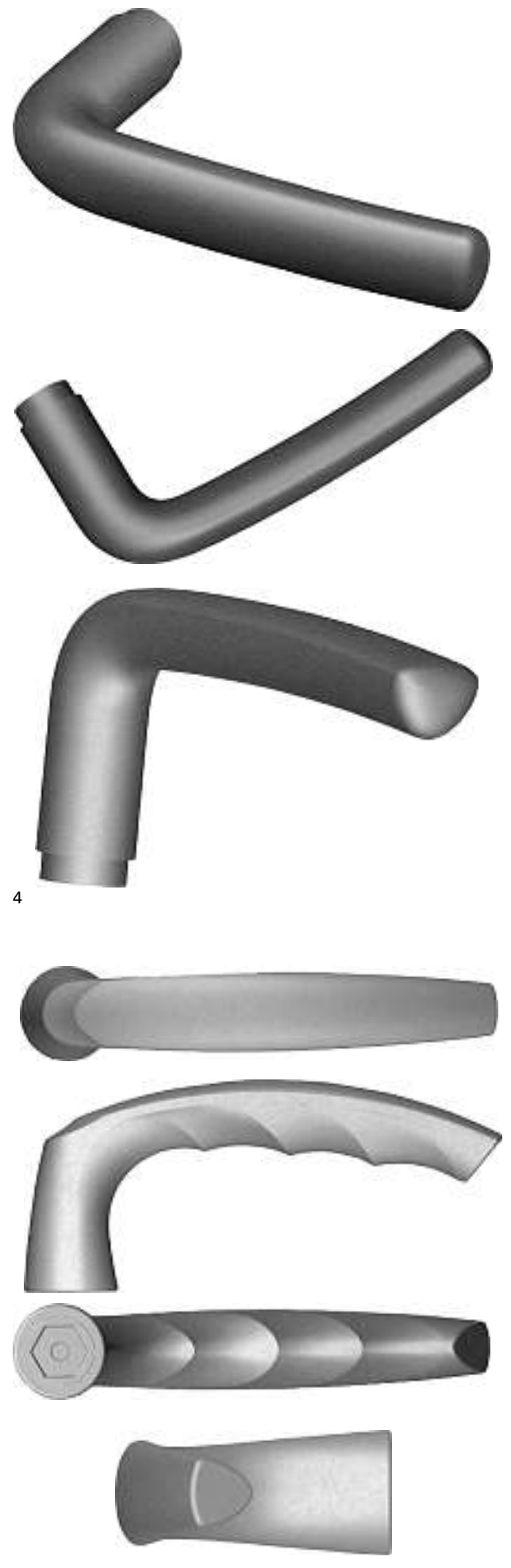
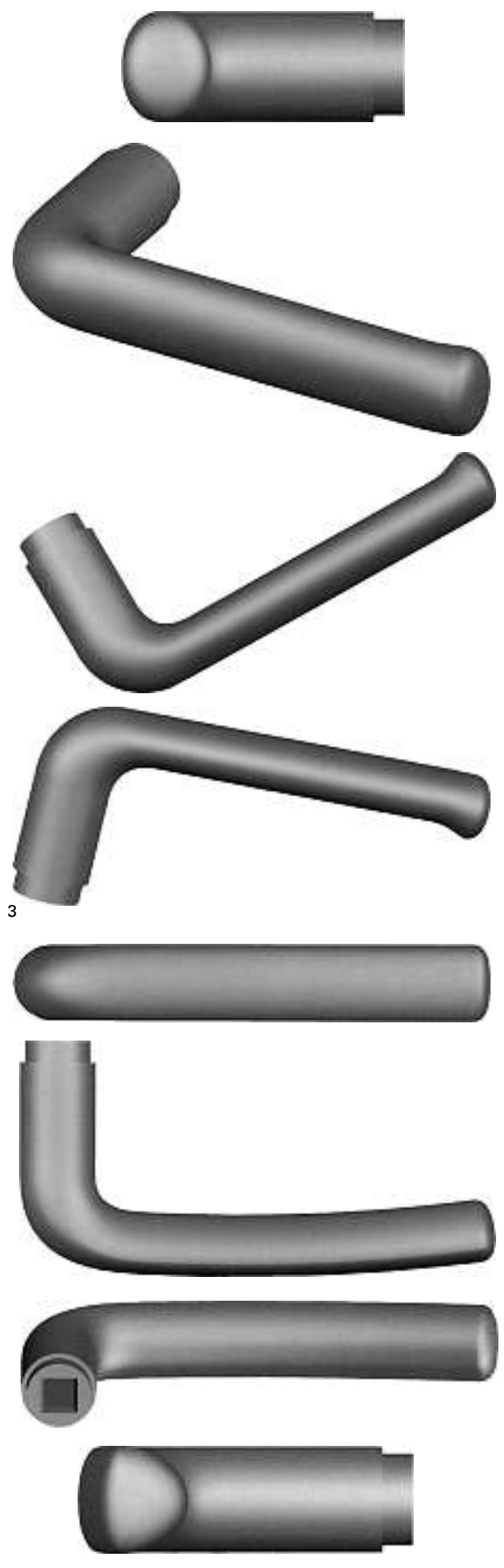

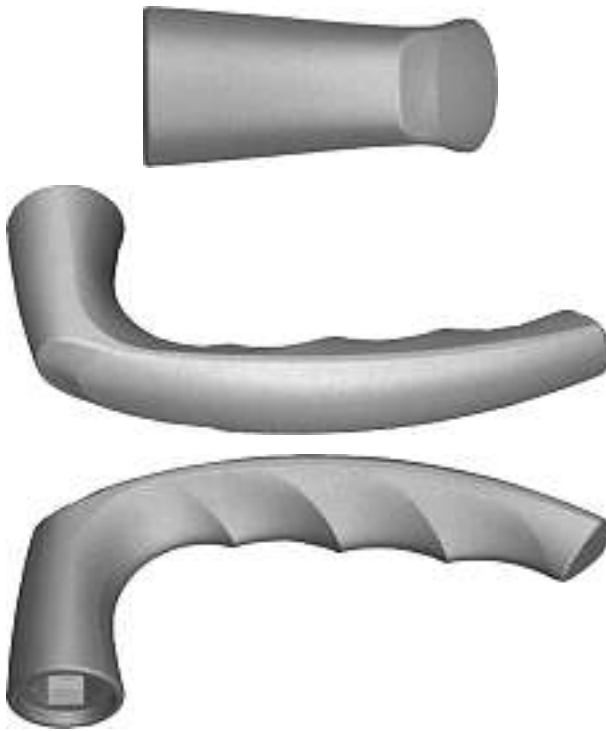

5

Cl. 08-08 131 515 02.02.2005
 1 Design – Aufhänger
 Hinterleger: Renato Guatelli, Hirzenfeldweg 100,
 3052 Zollikofen

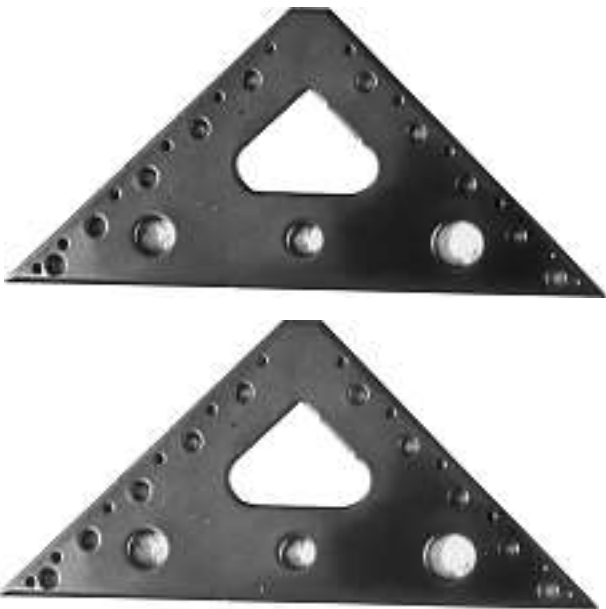

1/05

Cl. 08-09 131 516 21.12.2004
 36 Design – Türbeschlag
 Hinterleger: Kaba AG, Mühleühlstrasse 23, 8620 Wetzikon
 Designer: Werner Kühnlein, Meilen
 Vertreter: Frei Patentanwaltsbüro, 8032 Zürich

(siehe Farbteil Heftmitte)

Cl. 09-01 131 517 23.12.2004
 3 Design – Flasche
 Hinterleger: Companhia Brasileira de Bebidas, Avenida
 Antarctica, 1891 (parte), Fazenda Santa Ursula, Jaguariúna,
 São Paulo, BR
 Designer: Maaïke Van Besien, Wilsese; José Grétrý, Blegny;
 David Van Wees, Ridgefield
 Vertreter: Meyer Marks AG, 5620 Bremgarten AG
 Priorität: BR, 09.11.2004

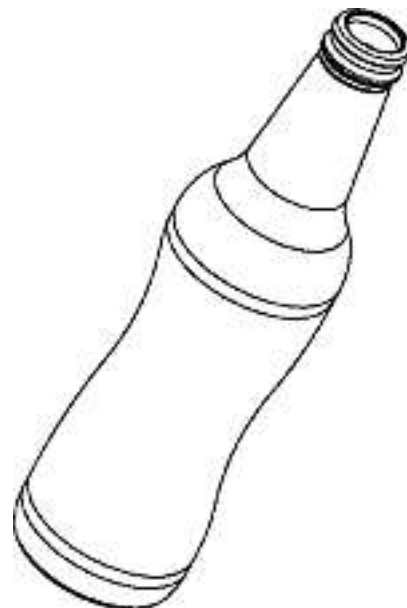
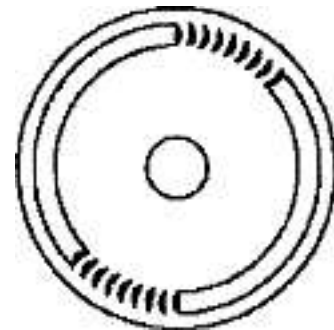
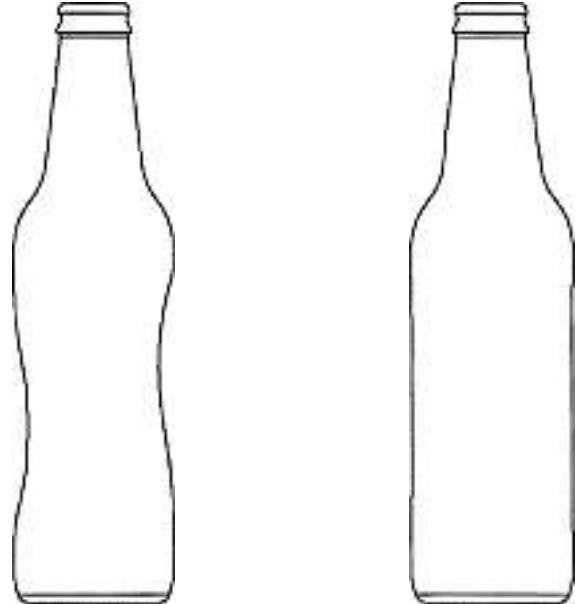

1

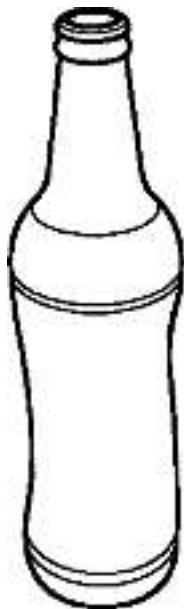
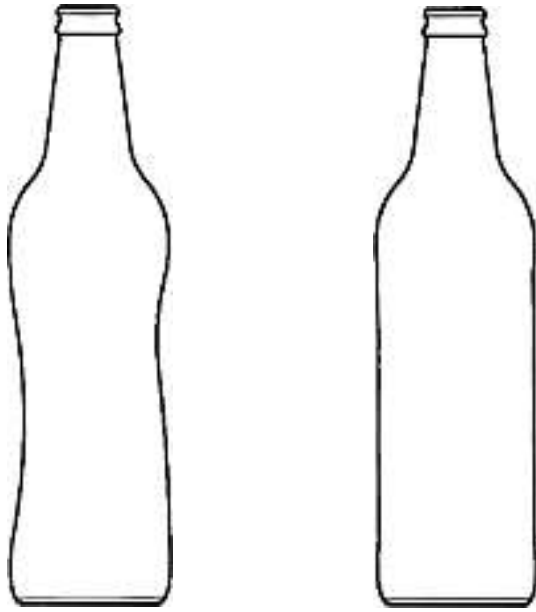

2



3

Cl. 09-01 **131 518** 04.02.2005
 1 Design – Flasche
 Hinterleger: Schweizer Getränke AG, Alte Landstrasse 144,
 8706 Obermeilen
 Designer: Jacqueline Fischer, Obermeilen
 Vertreter: A.W. Metz & Co. AG, 8024 Zürich



2486-CH-9-DC

Cl. 09-01 **131 519** 14.02.2005
 3 design – bouteille
 Déposant: Nestlé Waters France, 20, Rue Rouget de Lisle,
 Issy-les-Moulineaux, FR
 Designer: Cyrille Durand, Vittel; Nicolas Deluce, Nîmes
 Mandataire: Nestec S.A., 1800 Vevey
 Priorité: EM, 17.08.2004; EM, 17.08.2004; EM, 17.08.2004



FL 56933-1





FL 56933-2



FL 56933-3

Cl. 09-01 **131 520** 14.02.2005
 1 design – bouteille
 Déposant: Nestlé Waters France, 20, Rue Rouget de Lisle,
 Issy-les-Moulineaux, FR
 Designer: Cyrille Durand, Vittel; Nicolas Deluce, Nîmes
 Mandataire: Nestec S.A., 1800 Vevey
 Priorité: EM, 15.09.2004



FL 56934

Cl. 09-01 **131 521** 18.02.2005
 12 design – bouteilles
 Déposant: Nestlé Waters France, 20, Rue Rouget de Lisle,
 Issy-les-Moulineaux, FR
 Designer: Agnes Duranthon, Suresnes
 Mandataire: Nestec S.A., 1800 Vevey
 Priorité: EM, 13.09.2004; EM, 13.09.2004; EM, 13.09.2004; EM,
 13.09.2004; EM, 13.09.2004; EM, 13.09.2004; EM, 13.09.2004;
 EM, 13.09.2004; EM, 13.09.2004; EM, 13.09.2004; EM,
 13.09.2004; EM, 13.09.2004



1



2

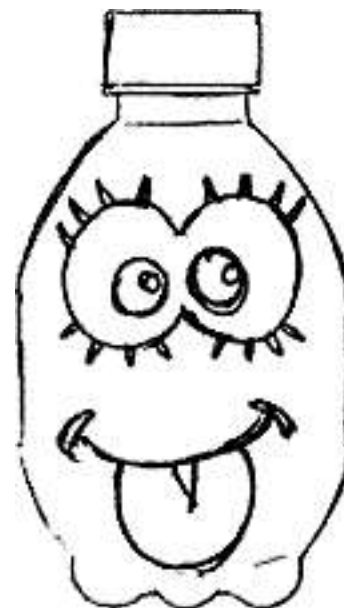

3



4



5



6



7



8



9

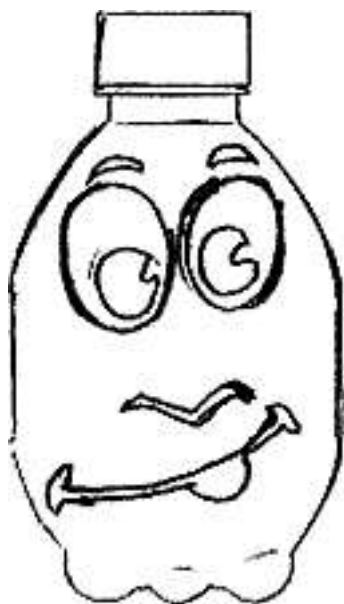

10



11



12

Cl. 09-03 **131 522** 04.01.2005
 20 Design – Verpackungsmuster
 Hinterleger: Mars, Incorporated, A Delaware Corporation,
 6885 Elm Street, McLean/VA, US
 Designer: Kai Kolterman, Hamburg; Ute Simon, Hamburg
 Vertreter: A.W. Metz & Co. AG, 8024 Zürich
 Priorität: EM, 05.07.2004
 (siehe Farbteil Heftmitte)

Cl. 09-03 **131 523** 08.02.2005
 5 Design – Zigaretttenpackung
 Hinterleger: Philip Morris Products S.A., Quai Jeanrenaud 3,
 2000 Neuchâtel
 Designer: Scott A. Fath, Richmond
 Vertreter: Bovard AG, 3000 Bern 25
 Priorität: US, 09.08.2004

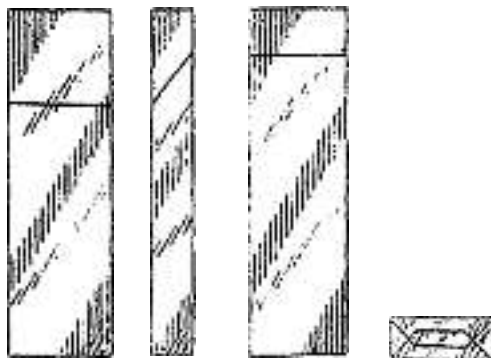

1

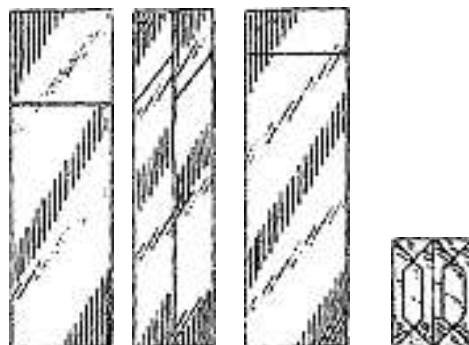

2

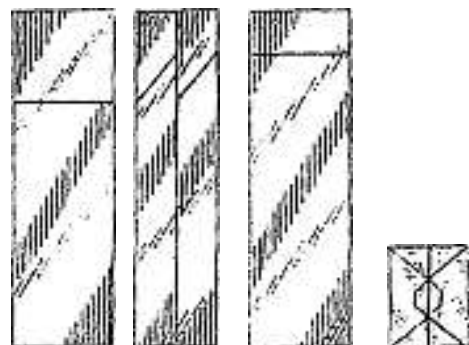

3

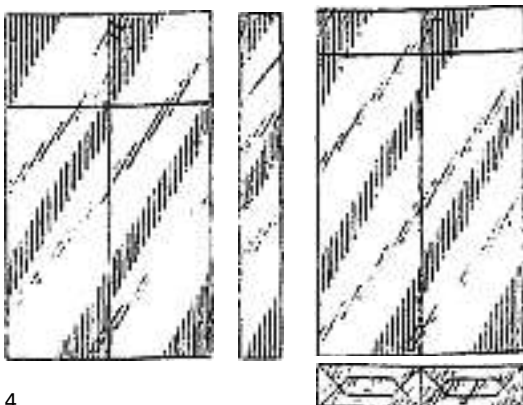

4

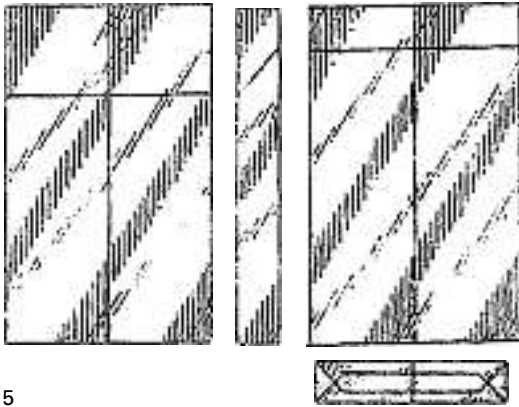

5

Cl. 09-03 131 524 28.02.2005
 1 Design – Lastwagenkiste
 Hinterleger: Knaack Manufacturing Company, 420 East Terra
 Cotta Avenue, Crystal Lake, IL 60014, US
 Designer: Tom Schwalie, Crystal Lake; Barry Bidingler,
 Palatine; Jerry Draffkorn, jun., Woodstock; Atul Saigal,
 Algonquin; Randy Hyde, Crystal Lake
 Vertreter: Isler & Pedrazzini AG, 8023 Zürich
 Priorität: US, 13.10.2004

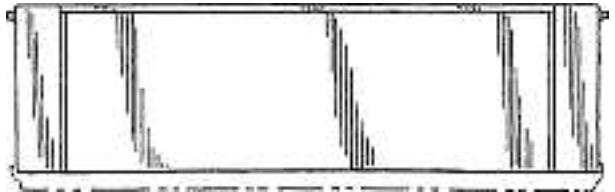
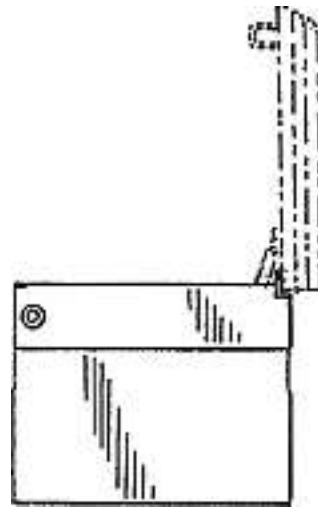
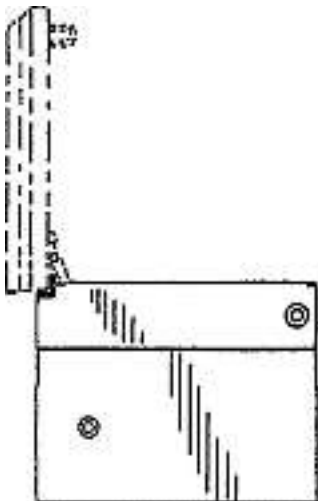
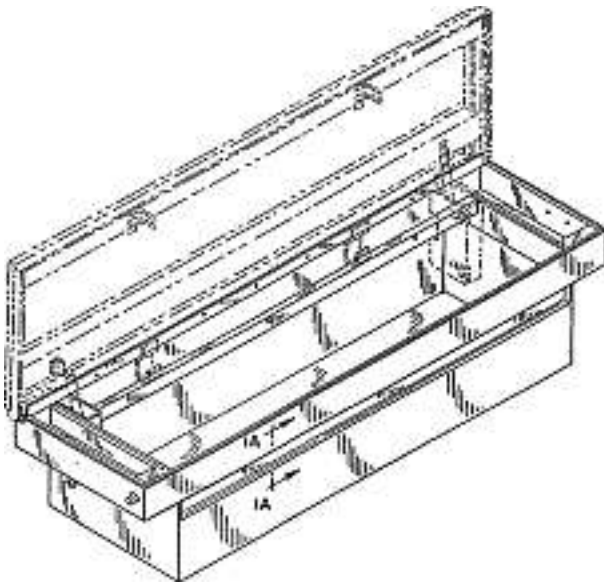
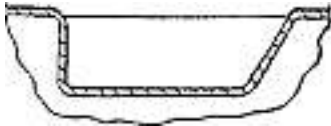

M13008

Cl. 09-03 131 525 09.03.2005
 1 Design – Verpackung
 Hinterleger: Mars, Incorporated, A Delaware Corporation,
 6885 Elm Street, McLean/VA, US
 Designer: Agnès Duranthon, Suresnes
 Vertreter: A.W. Metz & Co. AG, 8024 Zürich
 Priorität: EM, 30.09.2004

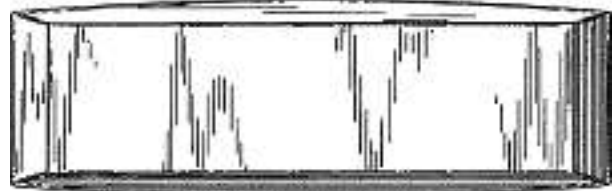
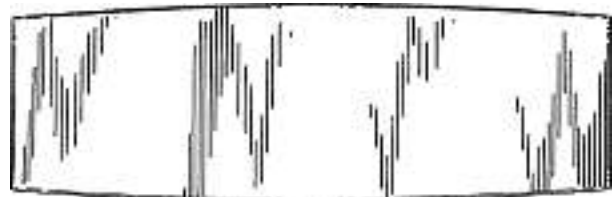
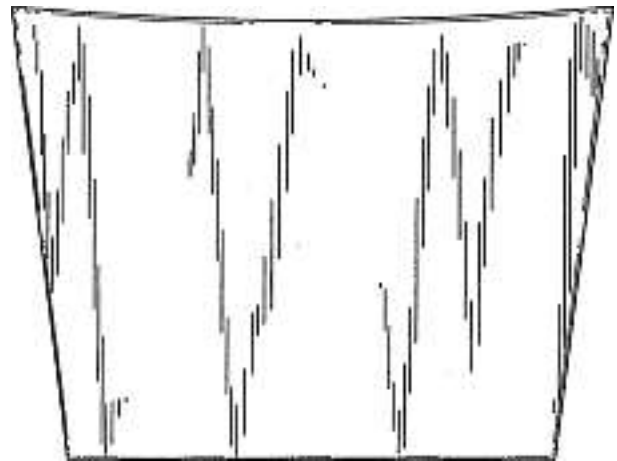
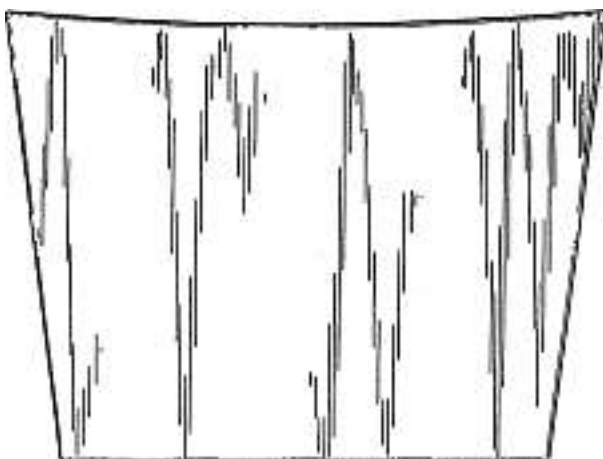
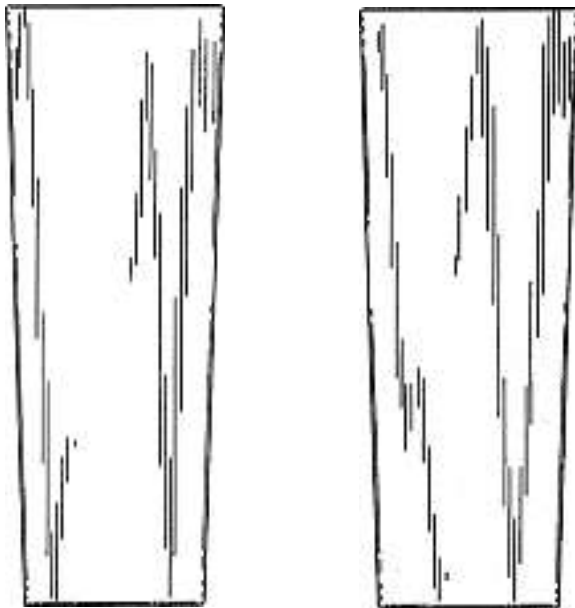
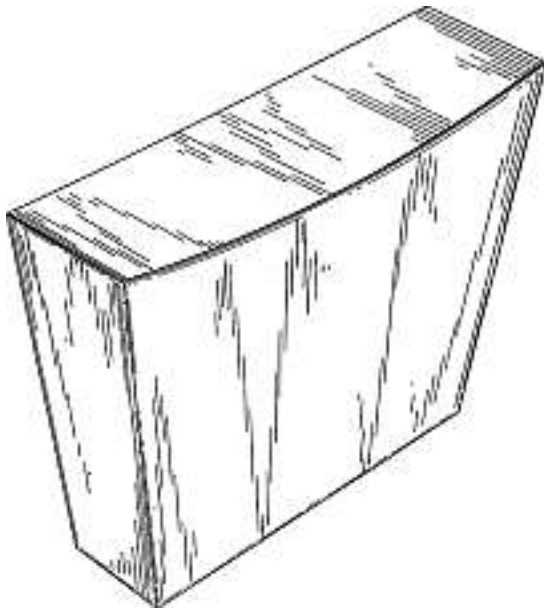

50896-CH-9-DJ

Cl. 09-05 131 526 01.03.2005
 16 design – conteneur
 Déposant: Astra Tech AB, Aminogatan 1, 431 21 Mölndal, SE
 Designer: Björn Bengtzelius, Göteborg; Richi Collet, Venray;
 Kent Engström, Malmö; Niklas Hofverberg, Göteborg
 Mandataire: Novagraaf International SA, 1220 Les Avanchets
 Priorité: EM, 15.09.2004

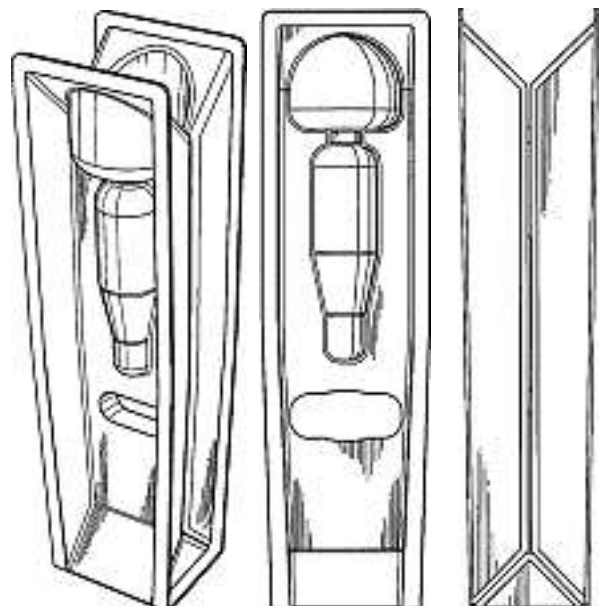

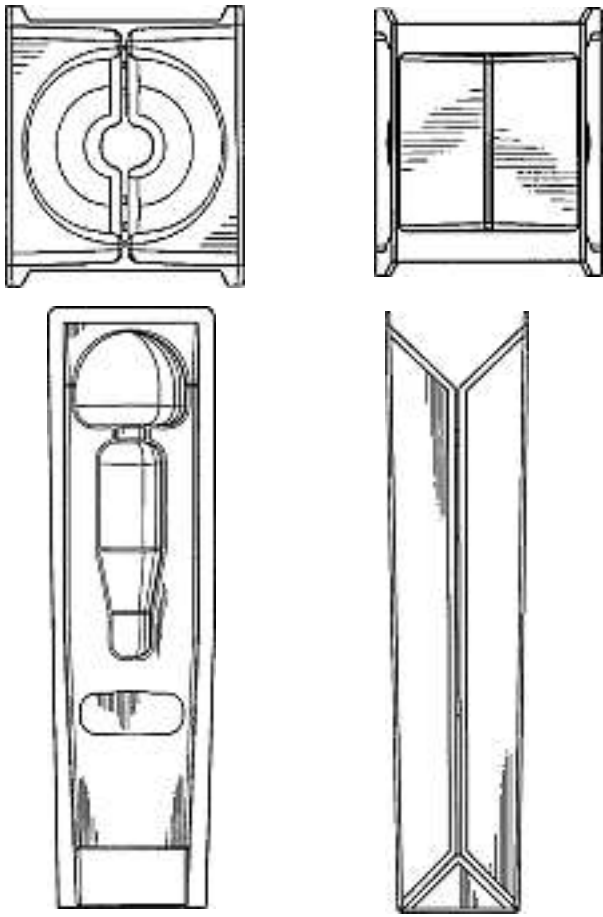

1

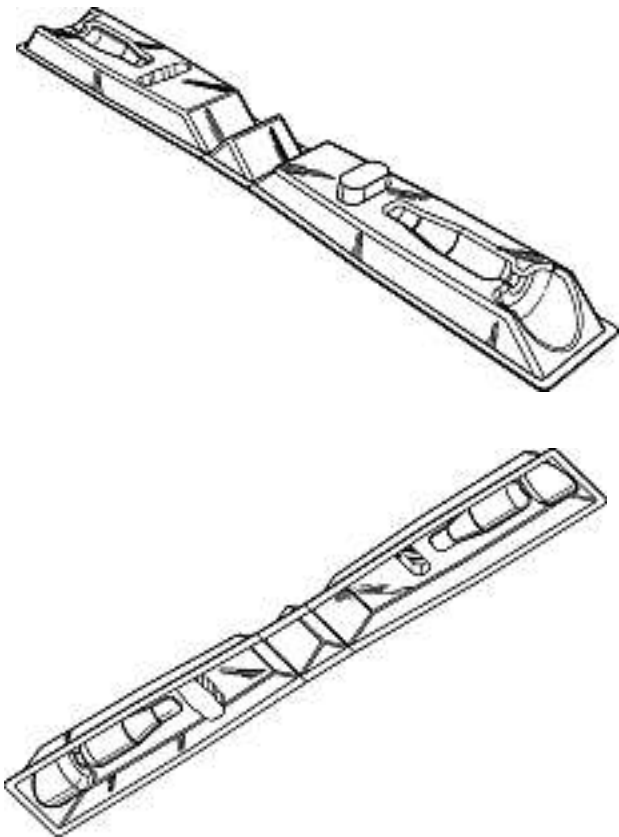

2

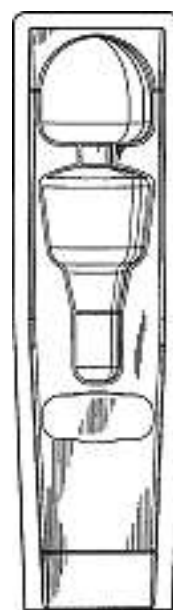
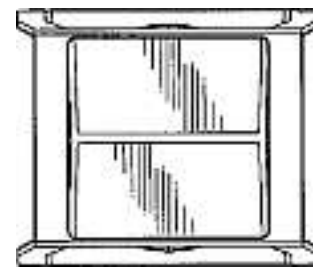
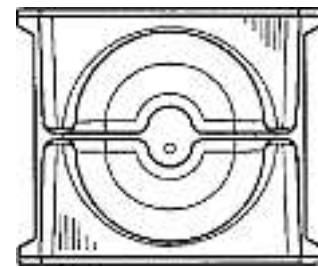
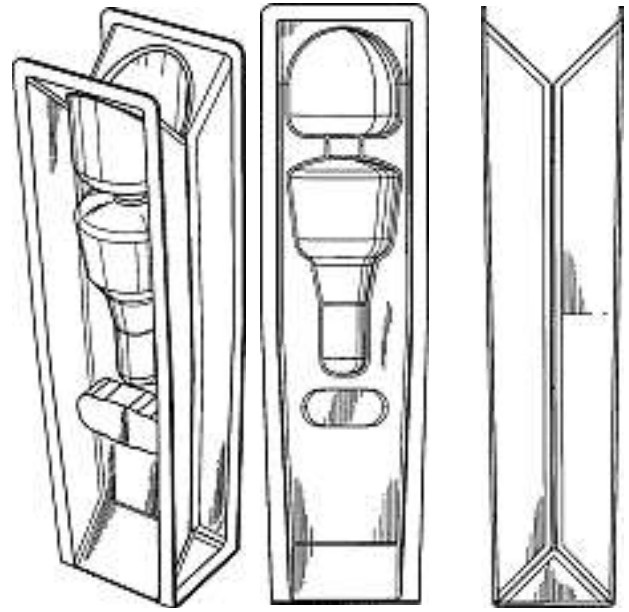

3

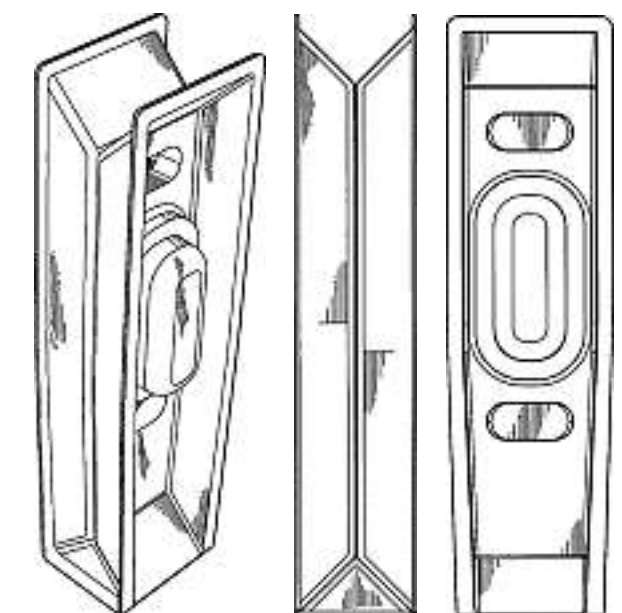
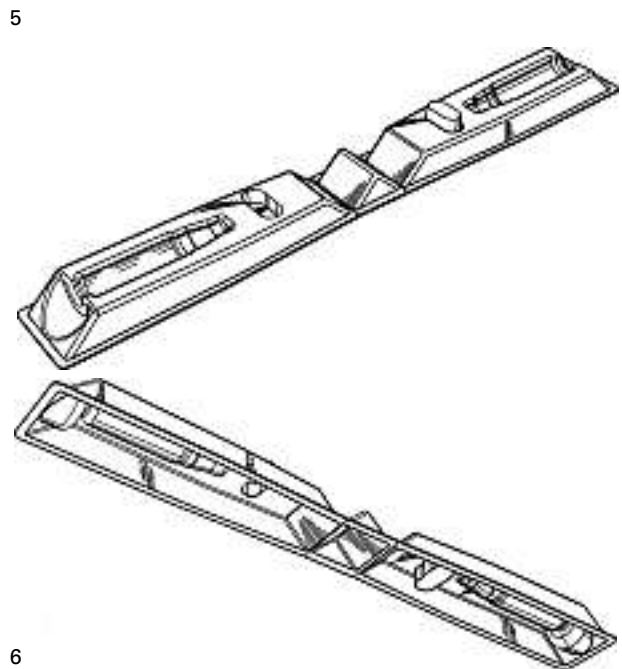
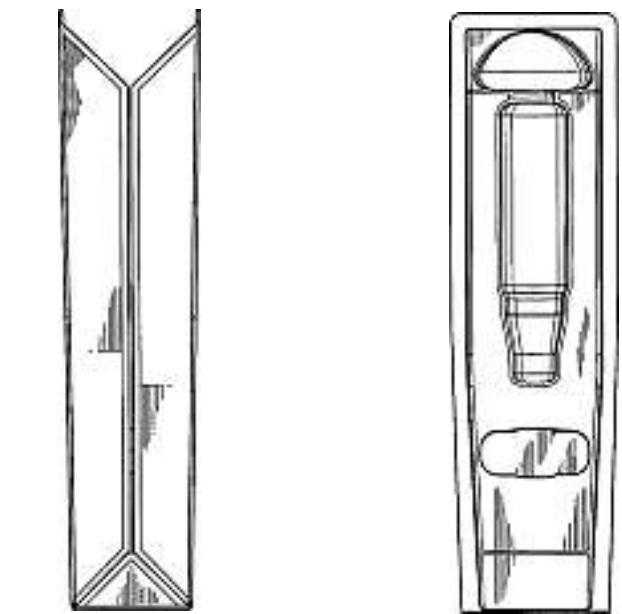
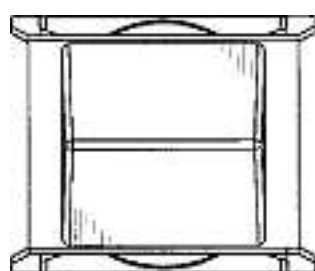
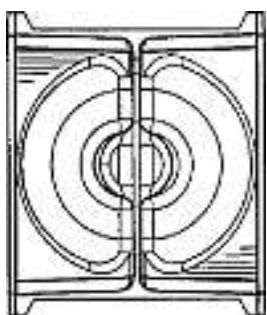
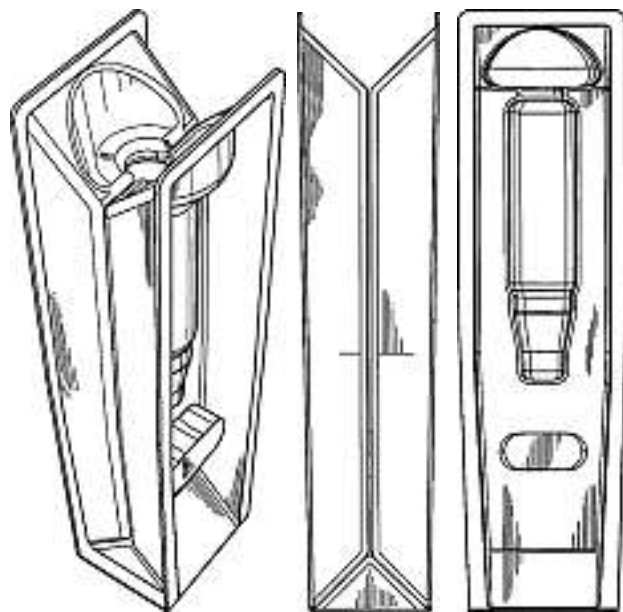
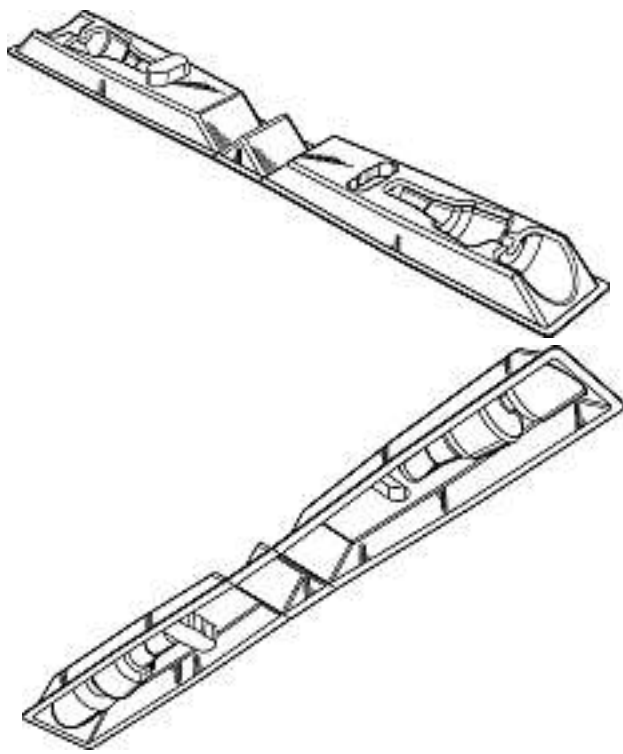

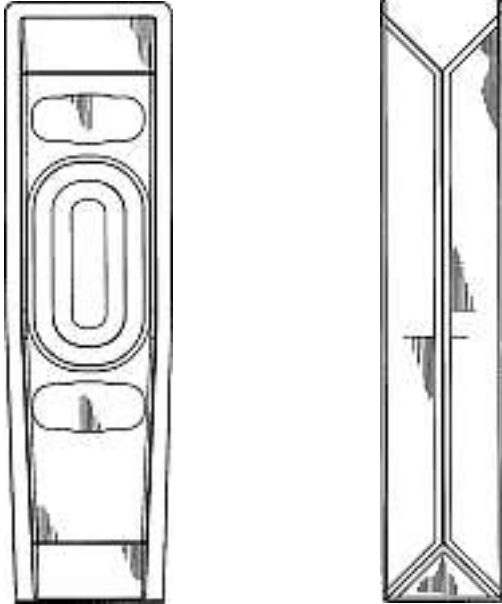
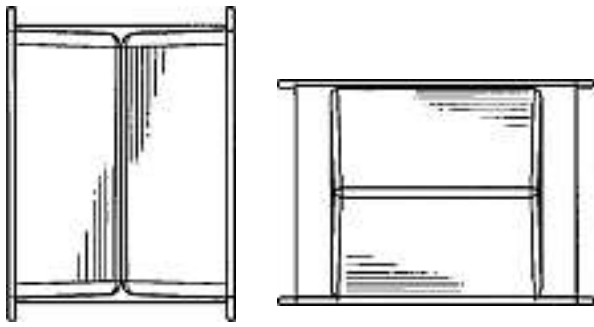

7

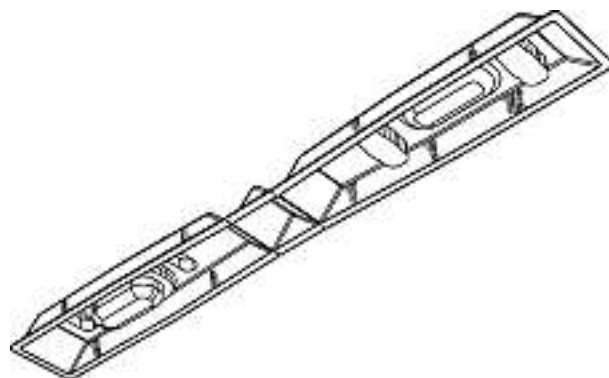
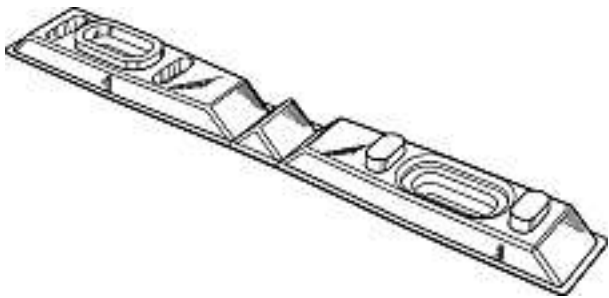

8

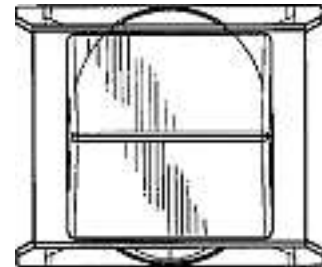
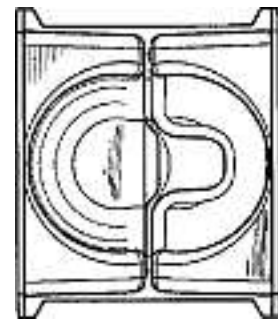
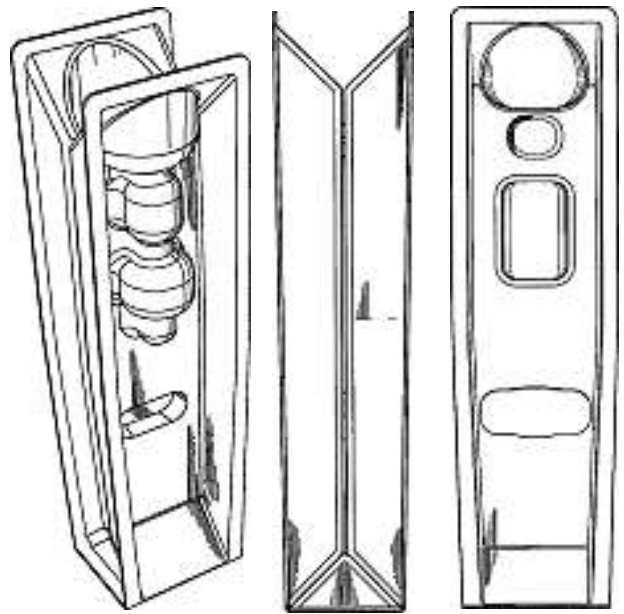

9

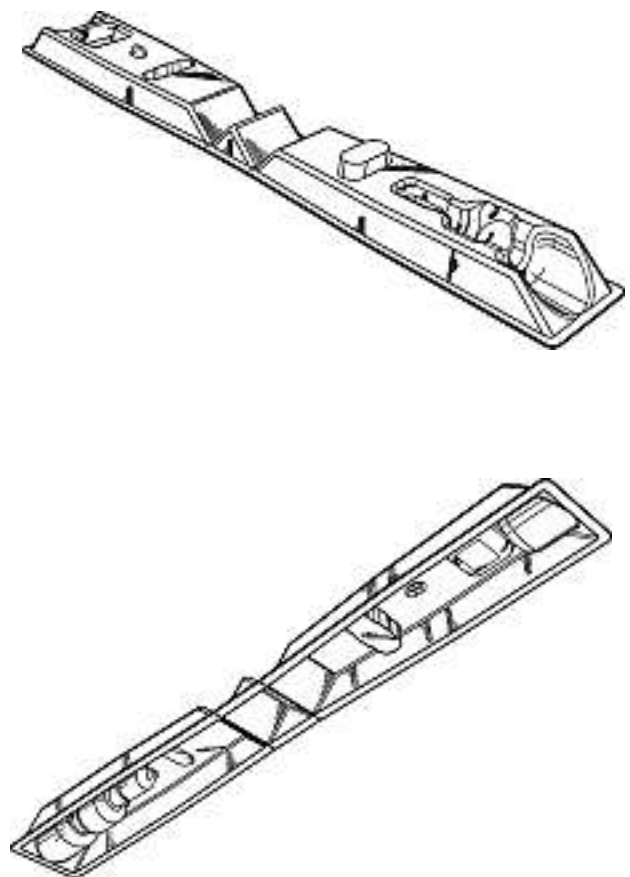
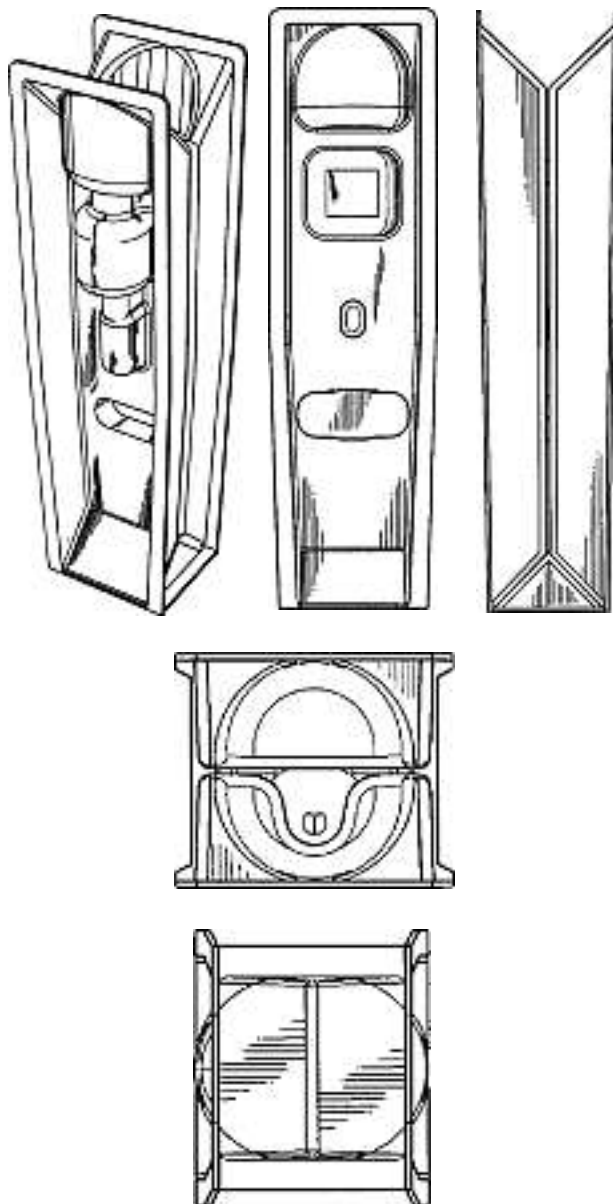
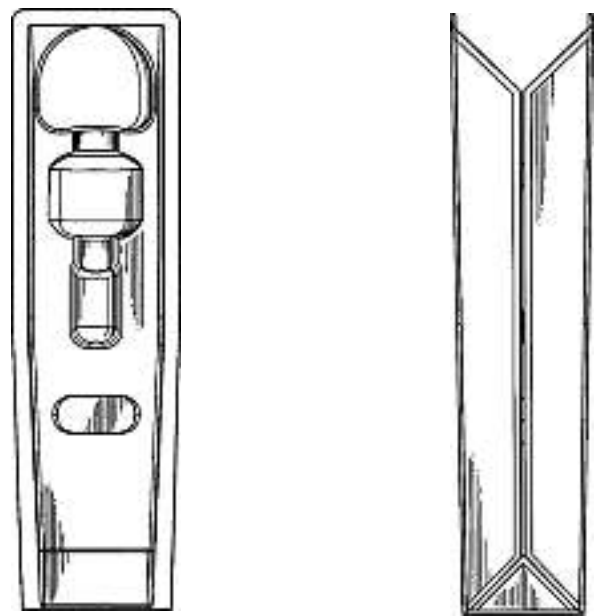
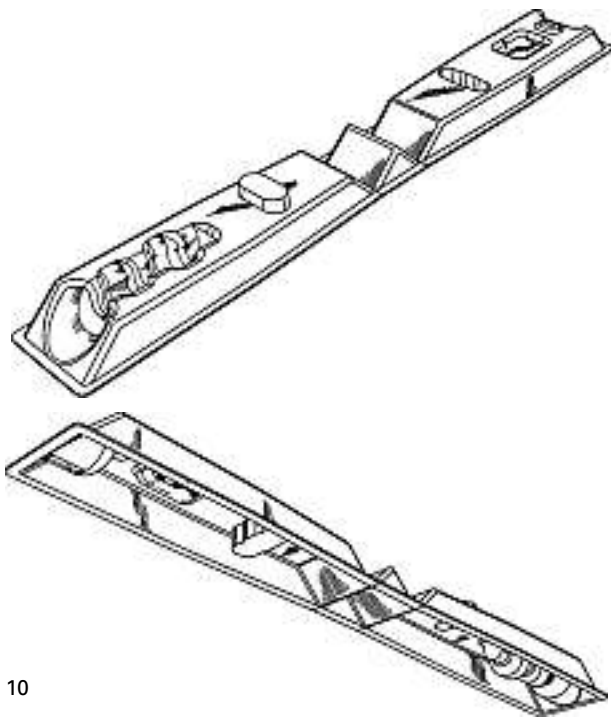

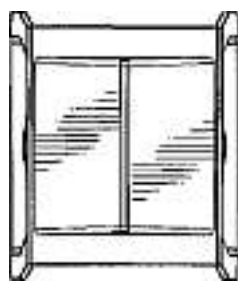
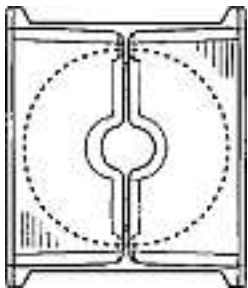
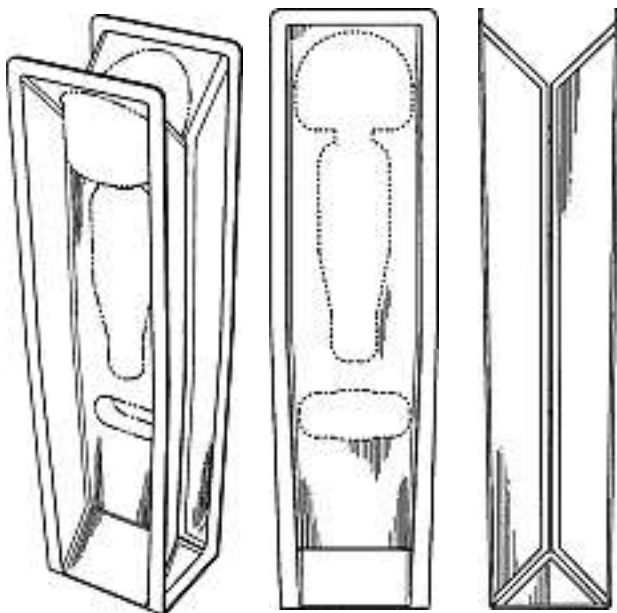

13

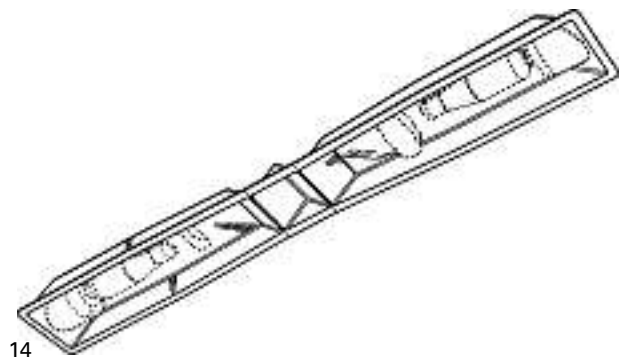
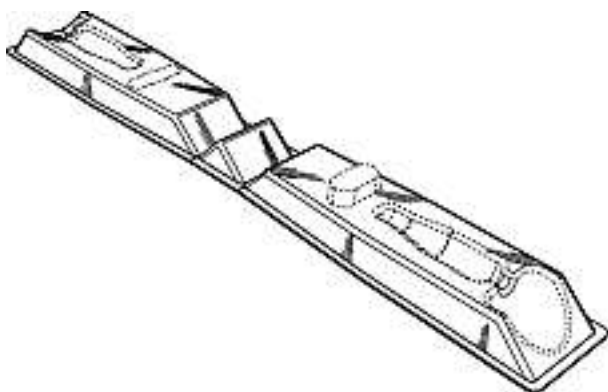

14

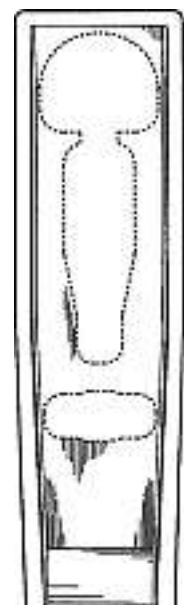
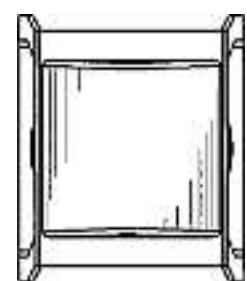
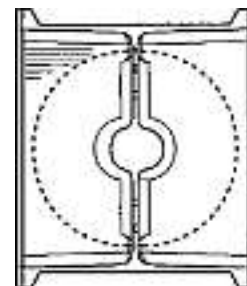
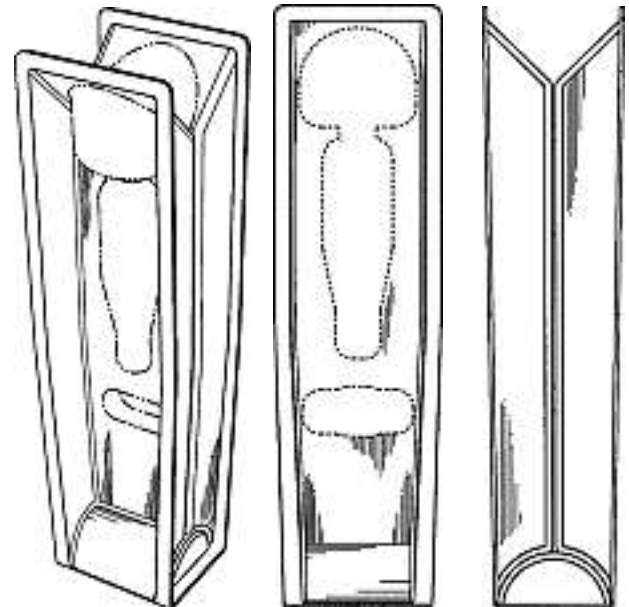

15

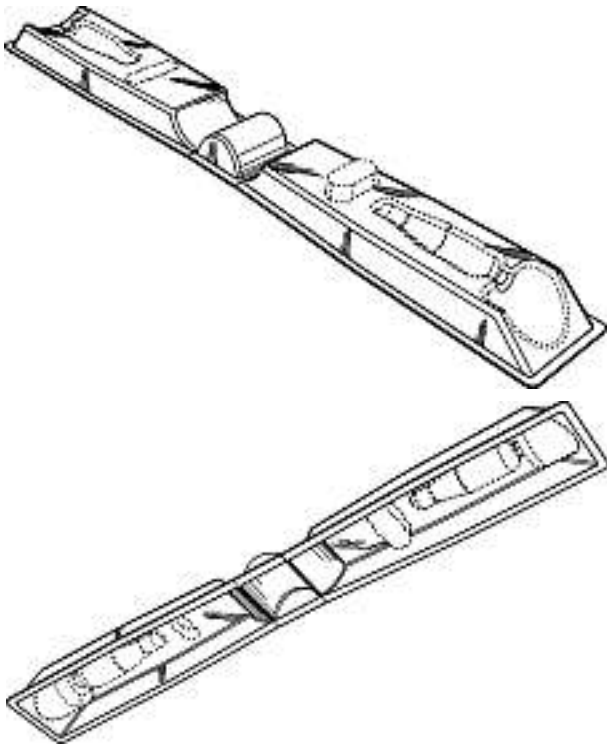

16

Cl. 10-02 131 527 27.01.2005
 1 design – montre-bracelet
 Déposant: SWISSATEC Sàrl, Rue H.-F. Sandoz 62, 2710 Tavannes
 Designer: Pierre-Alain Gilliéron, Tavannes
 Mandataire: CHEVRIER WATCH DISTRIBUTION, Jean-François Chèvre, 2502 Bienne



D-01/05 montre double face

Cl. 10-02 131 528 07.02.2005
 7 Design – Uhren
 Hinterleger: Aleksandar Stojanovic, Bodenacherstrasse 57, 8121 Benglen
 Designer: Hrvoje Srdelic, Zagreb



HS1



HS2



HS3



HS4



HS7



HS5



HS6

Cl. 10-07 **131 531** 10.03.2005
3 design – boîtes de montres
Déposant: Universal Genève S.A., 6 route des Acacias,
1211 Genève 24
Designer: Alexandre de la Riera, Genève
Mandataire: Kirker & Cie S.A., Ingénieurs-Conseils,
1226 Genève – Thônex





1



2





3

Cl. 11-01 131 532 03.02.2005
 14 Design – Schmuckbemusterung, Schmuckstücke
 Hinterleger: Ulysse Goldschmiede, U. Schmid,
 Engadinstrasse 51, Postfach 696, 7002 Chur
 Designer: Ulysses Schmid, Chur



1



2



3



4



5



8



6



9



7



10



11



14



12



13

Cl. 11-02 **131 533** 04.02.2005
1 Design – Ziergegenstand
Hinterleger: Jürgen Dähler, Engehaldenstrasse 85, 3012 Bern;
Simon Berger, Freiestrasse 23, 3012 Bern; Alois Baumann,
Limmatstrasse 246, 8049 Zürich
Vertreter: Jürgen Dähler, 3012 Bern

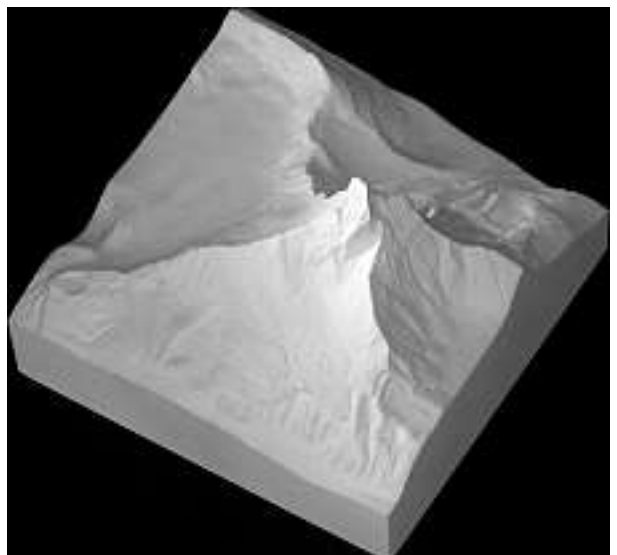
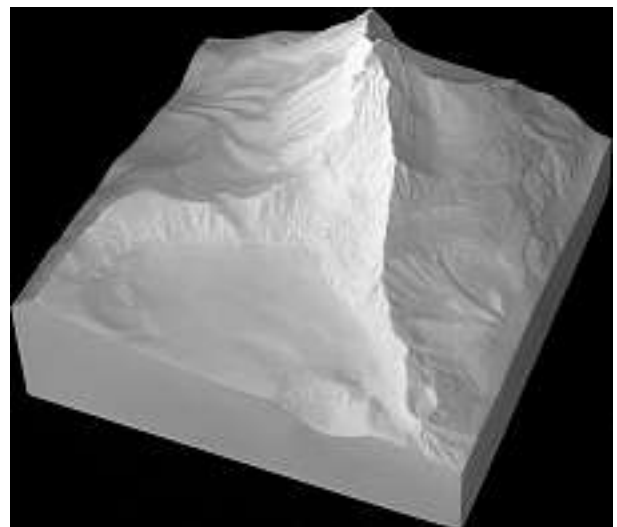

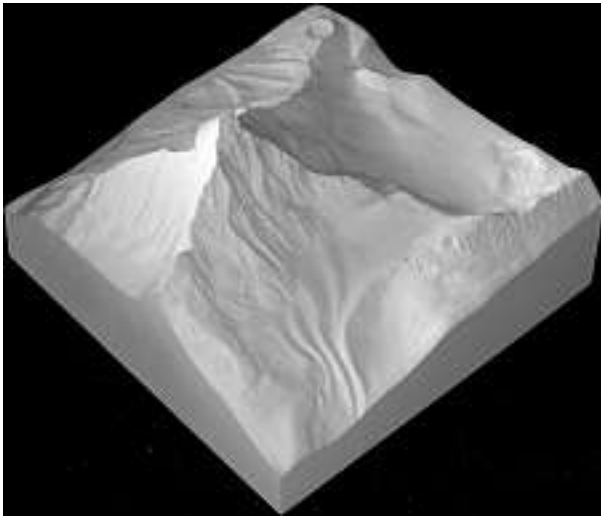

100001

Cl. 11-02 **131 534** 21.02.2005
 1 Design – Vase
 Hinterleger: GaliLeO AG, Schulhausstrasse 10, 4800 Zofingen
 Designer: Verena Staufert, Zofingen
 Vertreter: Verena Staufert, 4800 Zofingen

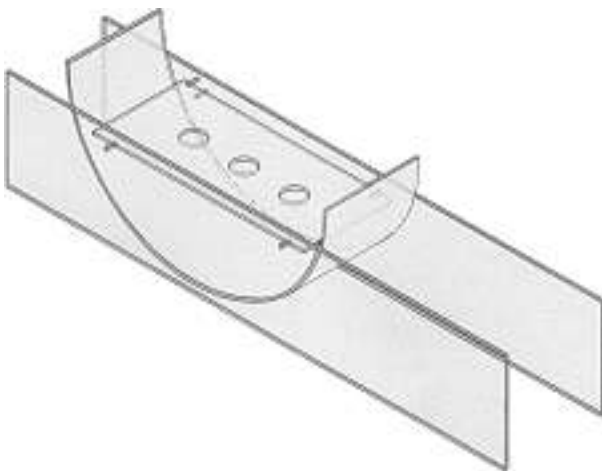
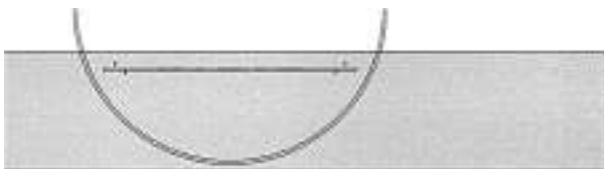

1

Cl. 12-14 **131 535** 27.02.2005
 16 Design – Schlitten, Schlittenteile,
 Schlittenseitenwandelement, Schlittensitz
 Hinterleger: SWISSLED GmbH, Mühleweg 19, 3280 Murten
 Designer: Christian Zürcher, Murten

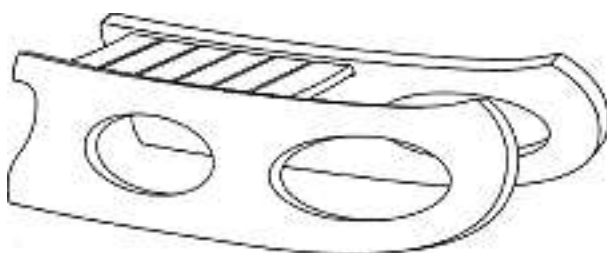

1-2005



2-2005



3-2005



4-2005



5-2005



6-2005



7-2005



8-2005



9-2005

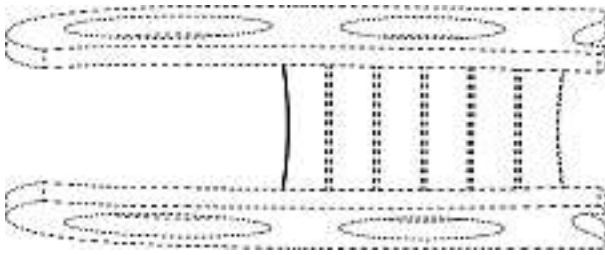

10-2005

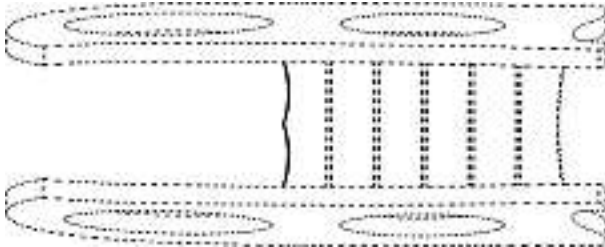

11-2005

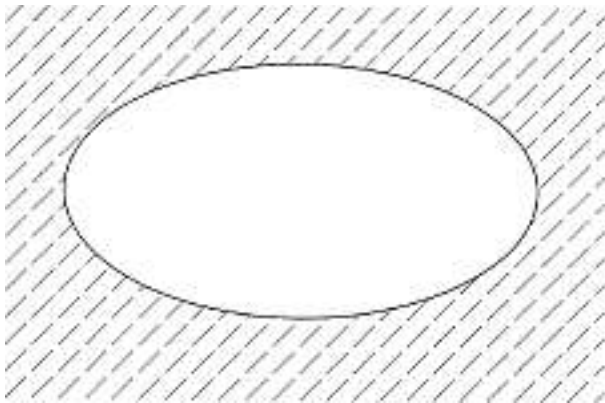

12-2005

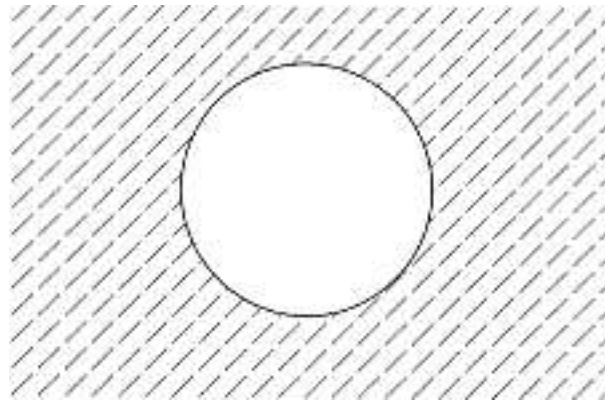

13-2005

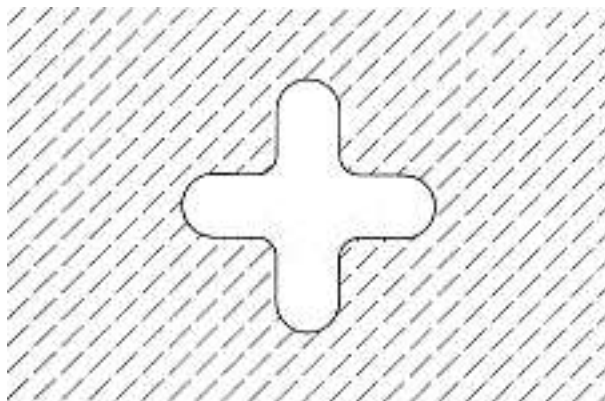

14-2005

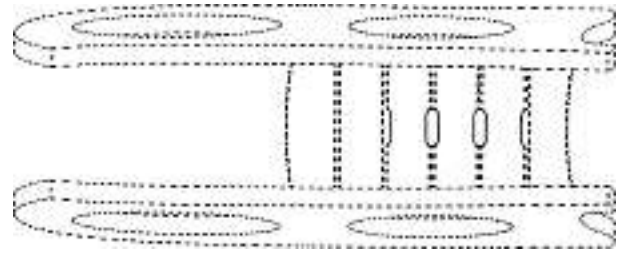

15-2005

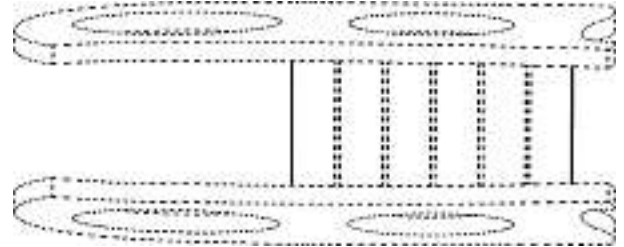

16-2005

Cl. 13-01 **131 536** 31.01.2005
 1 Design – Generator
 Hinterleger: Rinco Holding AG, Industriestrasse 4,
 8590 Romanshorn
 Designer: Wolfram Kuhr, Konstanz
 Vertreter: Wild Schnyder AG, 8032 Zürich



A

Cl. 13-03 **131 537** 31.01.2005
 8 Design – Konverter
 Hinterleger: Rinco Holding AG, Industriestrasse 4,
 8590 Romanshorn
 Designer: Andreas Beer, Bernhardzell
 Vertreter: Wild Schnyder AG, 8032 Zürich

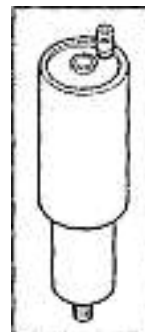

A



B

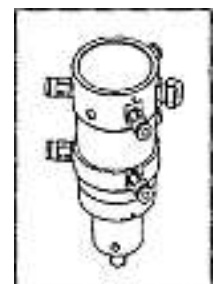

C

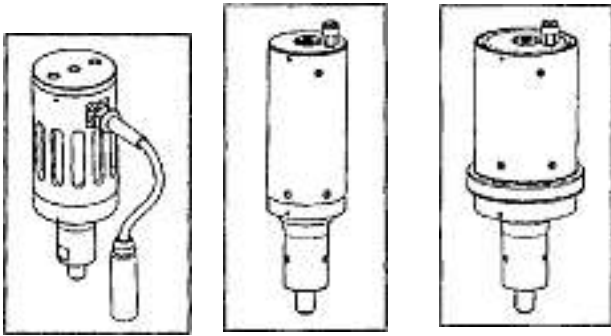

D

E

F

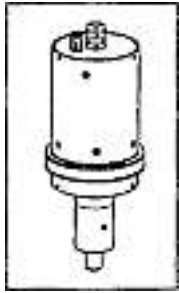

G

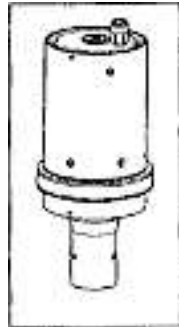

H



Cl. 14-02 131 538 16.02.2005
 2 Design – Gehäuse
 Hinterleger: Rittal GmbH & Co. KG, Auf dem Stützelberg,
 35745 Herborn, DE
 Designer: Christoph Ludwig, Offenbach; Christoph Könnecke,
 Frankfurt
 Vertreter: Felber & Partner AG, 8034 Zürich
 Priorität: DE, 13.10.2004

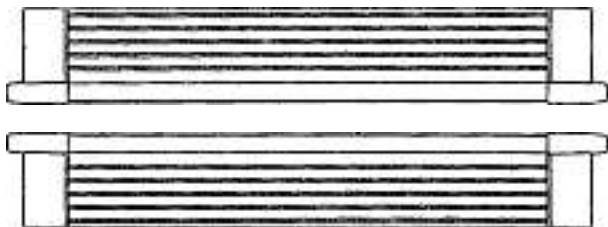
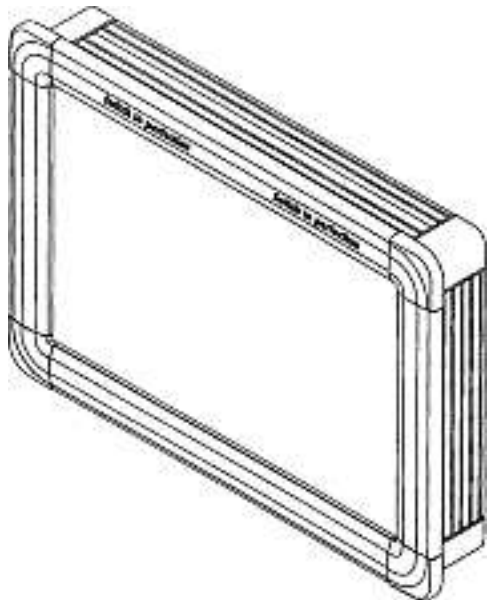

Gehäuse 1



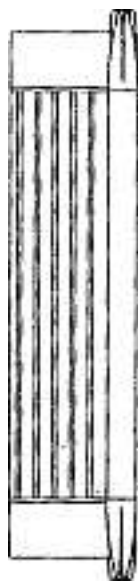
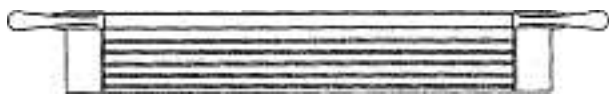
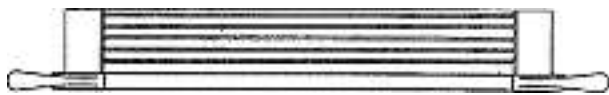
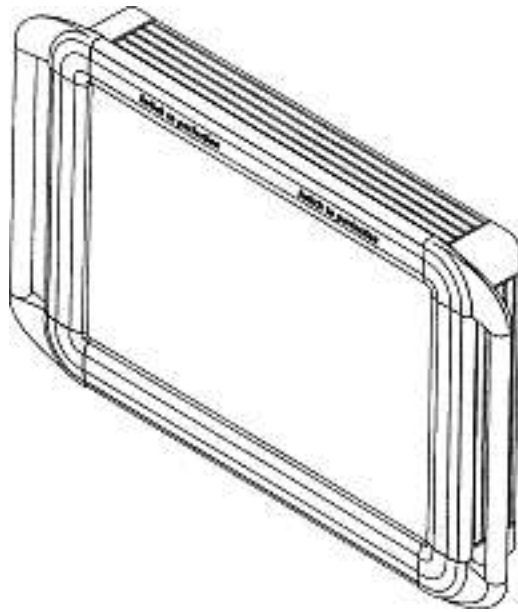

Gehäuse 2

Cl. 14-99 **131 539** 05.01.2005
 1 Design – Halter
 Hinterleger: Renato Corsi, Hertensteinstrasse 24, 6004 Luzern
 Designer: Diego Kaufmann, Luzern

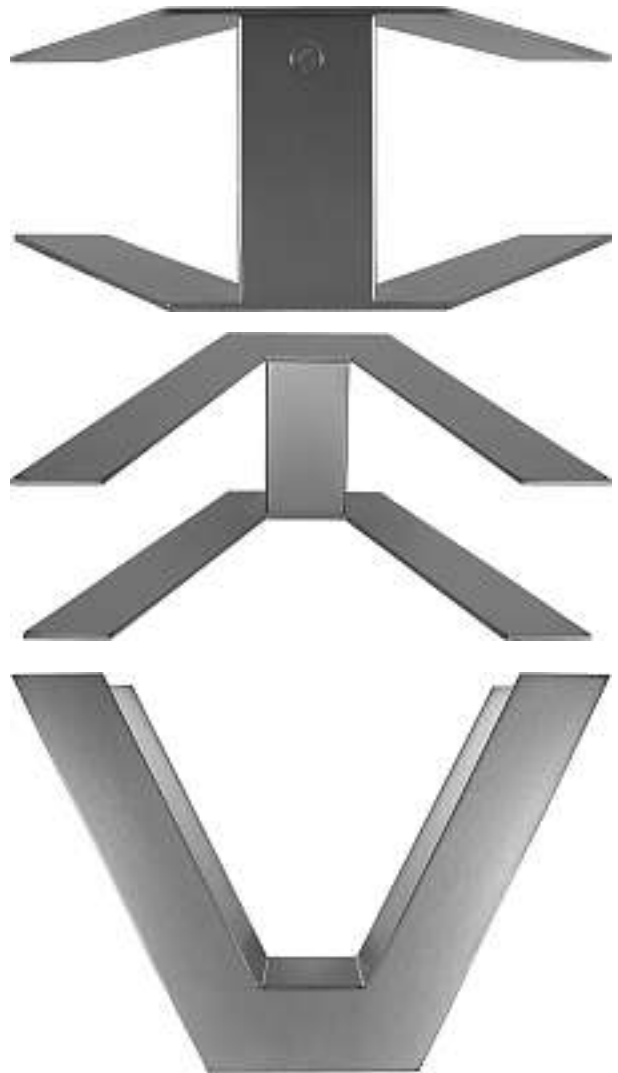

1490C/E

Cl. 15-07 **131 540** 24.02.2005
 7 Design – Kühlmaschinen und -apparate
 Hinterleger: AHT Cooling Systems GmbH & Co. KG,
 Werksgasse 57, Rottenmann, AT
 Designer: Reinhold Resch, Rottenmann
 Vertreter: E. Blum & Co., 8044 Zürich
 Priorität: EM, 27.08.2004

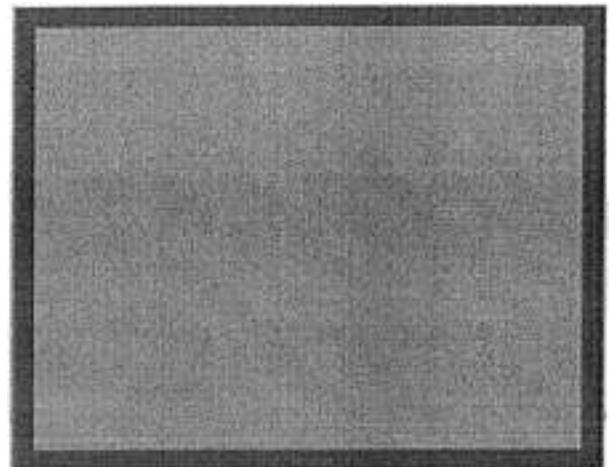

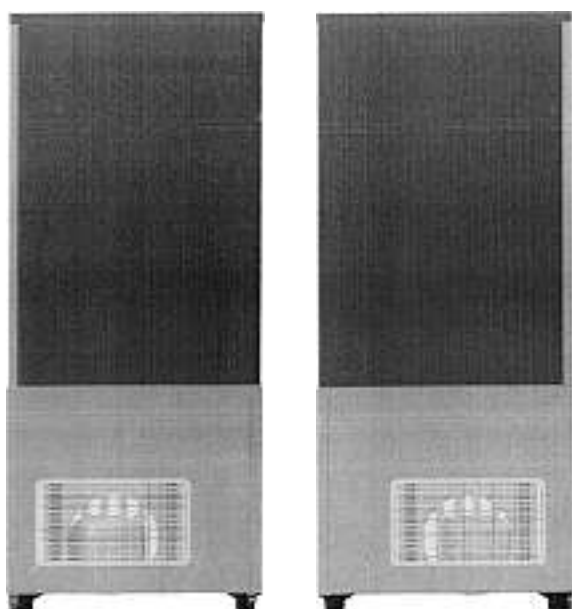
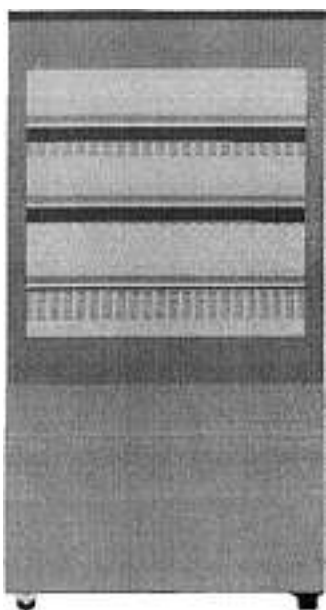

A-2005/1010a

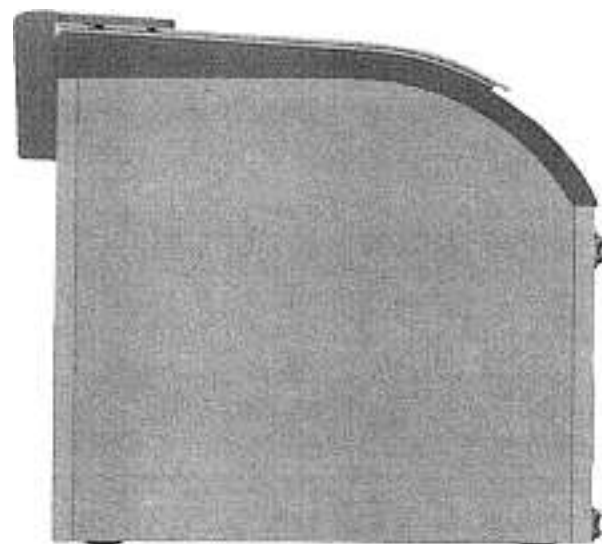
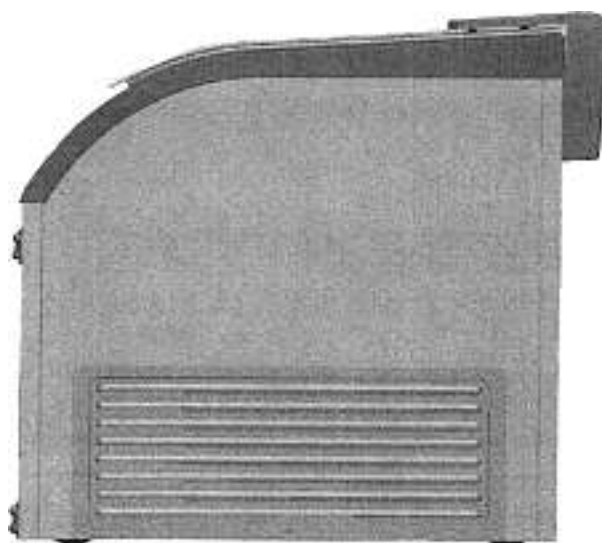
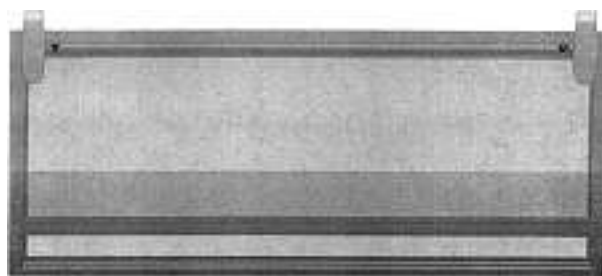

A-2005/1010b

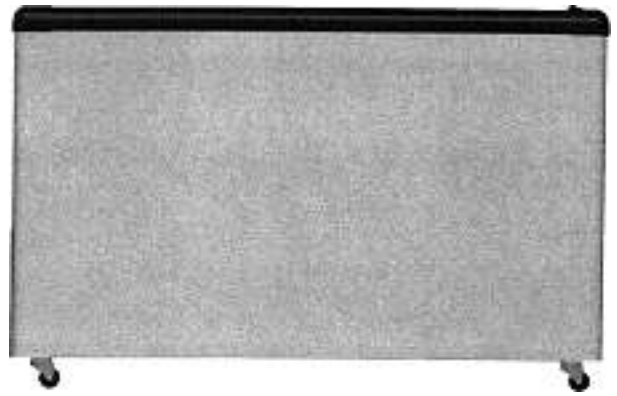
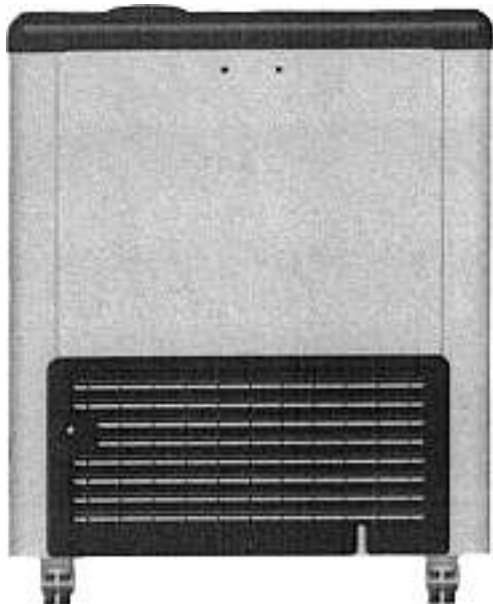
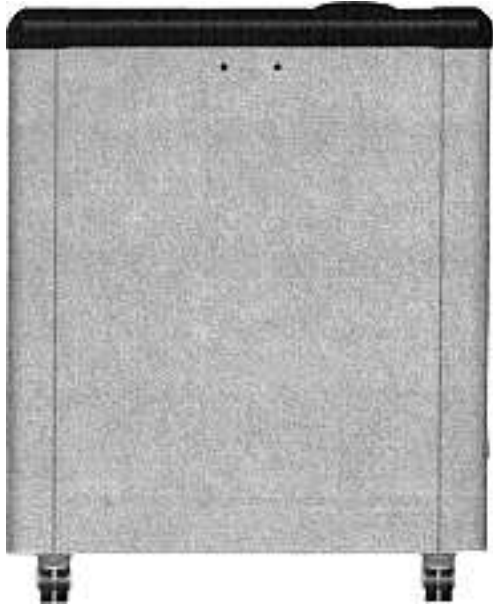
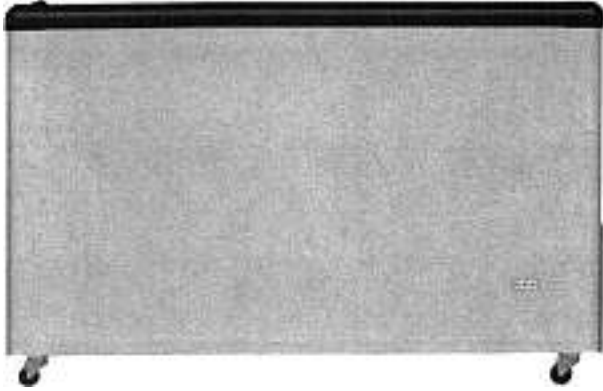
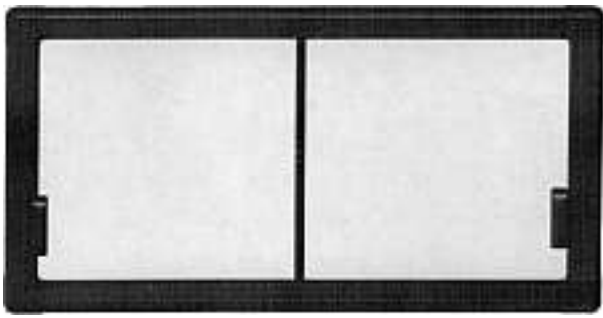

A-2005/1010c

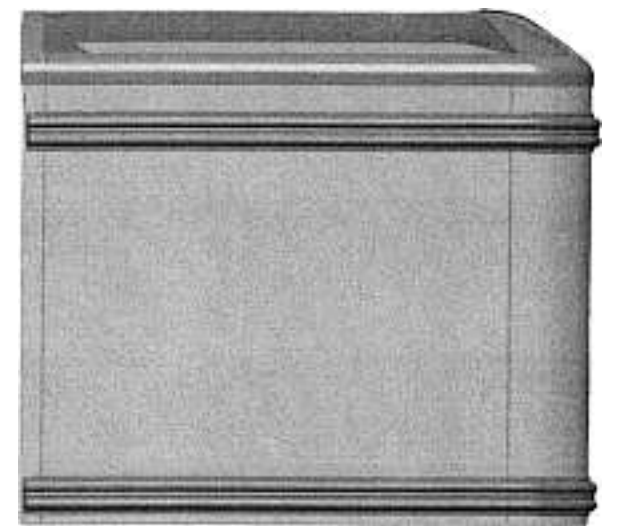
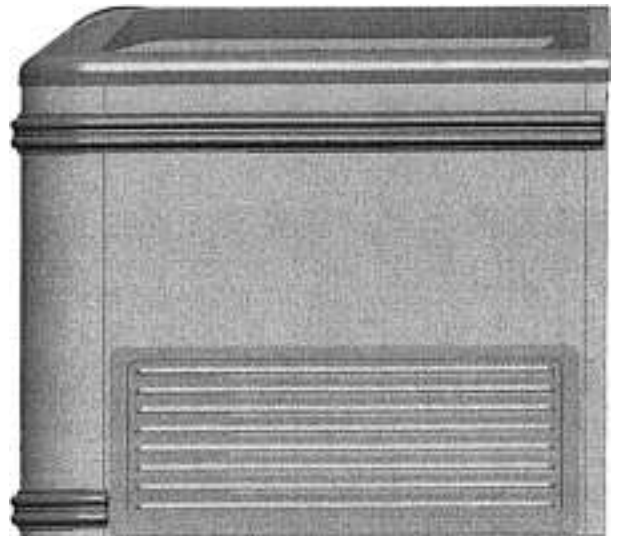
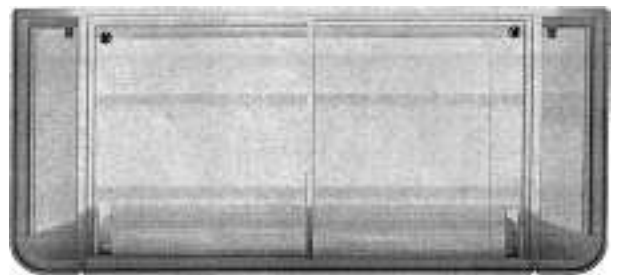

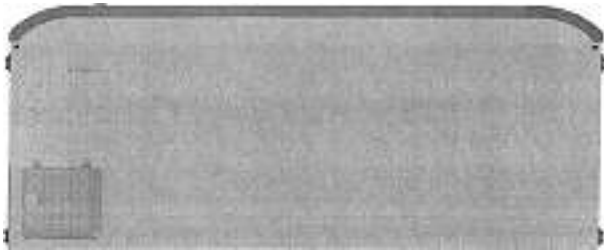
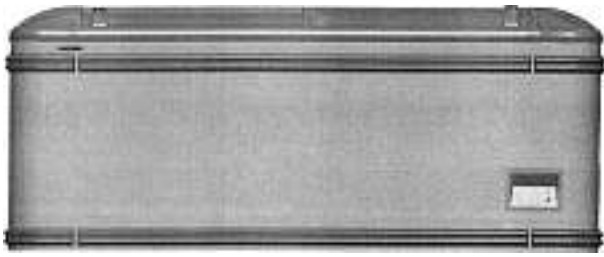

A-2005/1010d

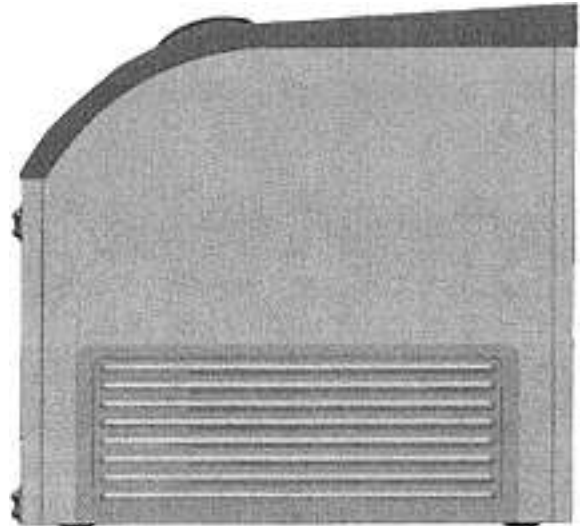
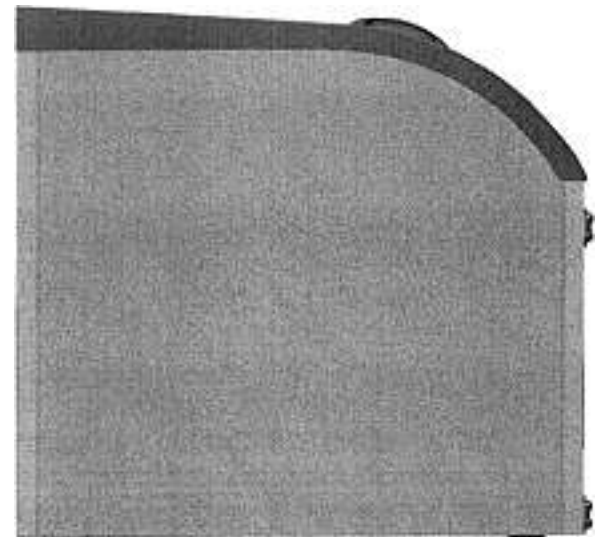
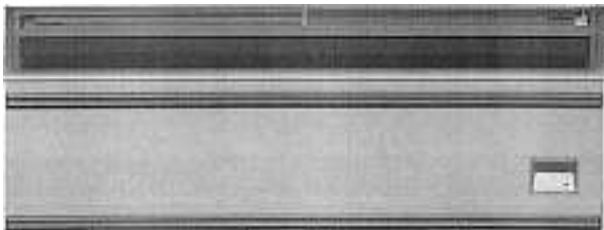
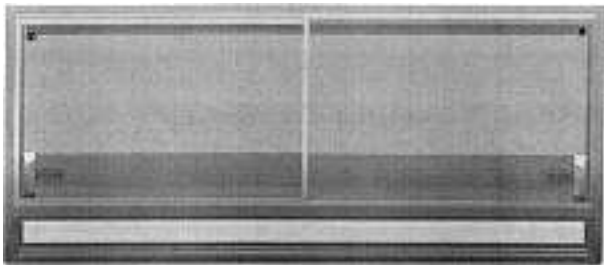

A-2005/1010e

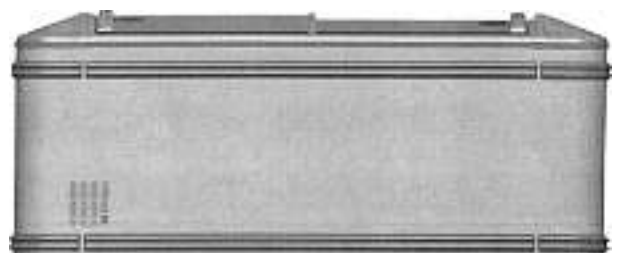
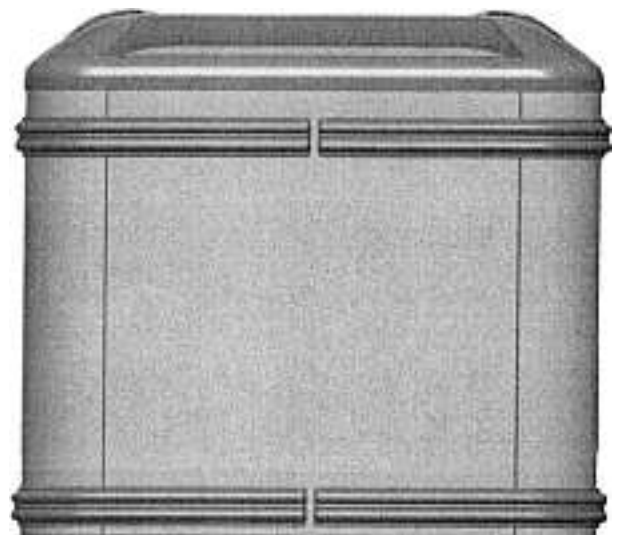
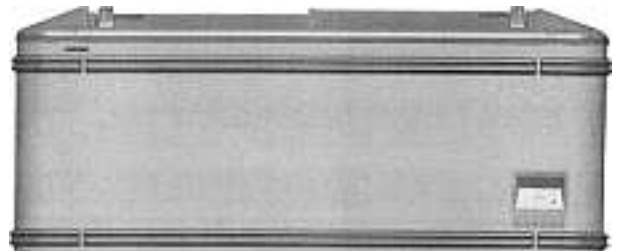
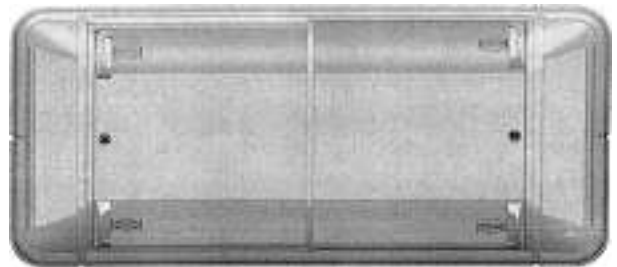

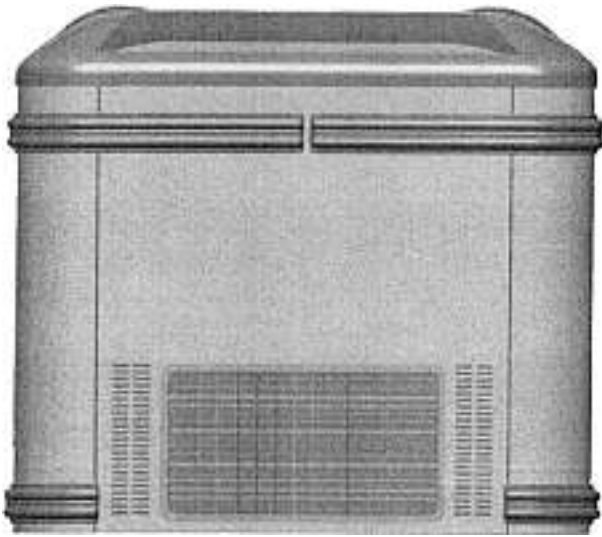

A-2005/1010f



A-2005/1010g

Cl. 15-09 **131 541** 31.01.2005
 2 Design – Schweissanlage
 Hinterleger: Rinco Holding AG, Industriestrasse 4,
 8590 Romanshorn
 Designer: Andreas Beer, Bernhardzell
 Vertreter: Wild Schnyder AG, 8032 Zürich

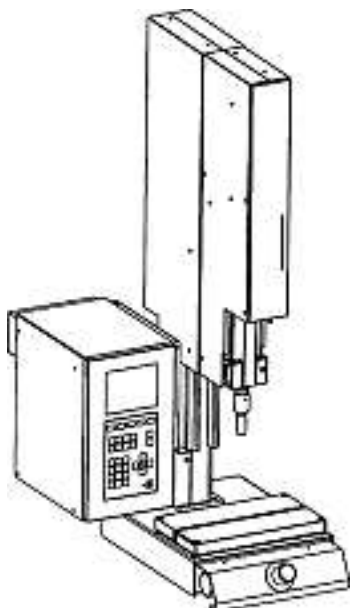

A

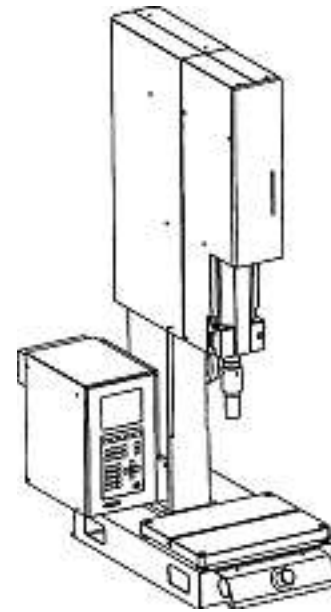

B

Cl. 15-99 **131 542** 14.02.2005
 1 Design – Schlammsauger
 Hinterleger: Arnold Wunschgärten GmbH, Chrüzwies 16,
 8852 Altendorf
 Designer: Franz Arnold, Altendorf

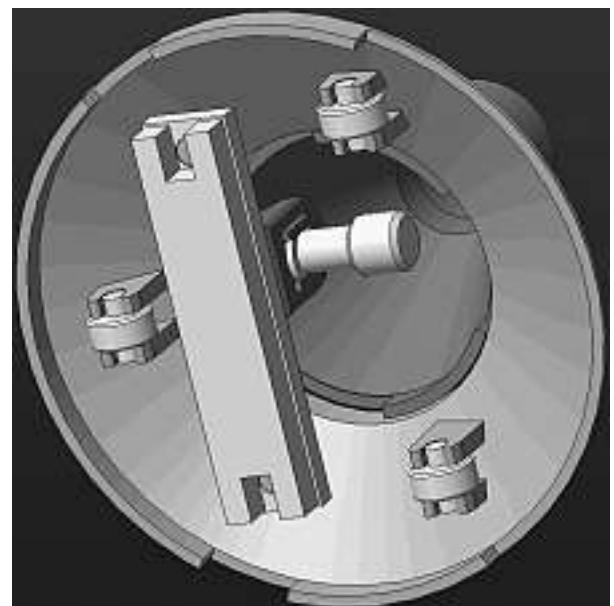
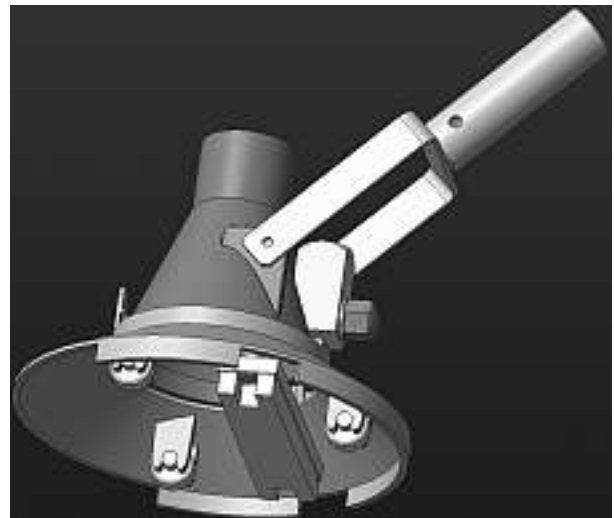

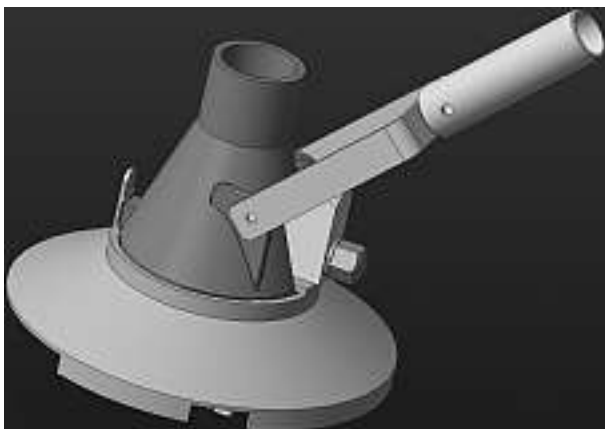

Arnold Sedimentsauger

Cl. 15-99 **131 543** 09.03.2005
 1 Design – Schalter
 Hinterleger: Olsbergs Hydraulics AB, Maskingatan 3, Box 17,
 Eksjö, SE
 Designer: Göran Henriksson, Eksjö; Jan-Erik Steen,
 Vallentuna
 Vertreter: Patentanwälte, Schaad, Balass, Menzl & Partner AG,
 8034 Zürich
 Priorität: EM, 21.09.2004

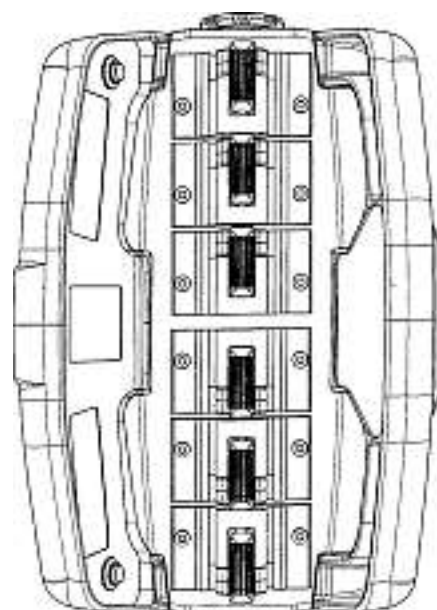
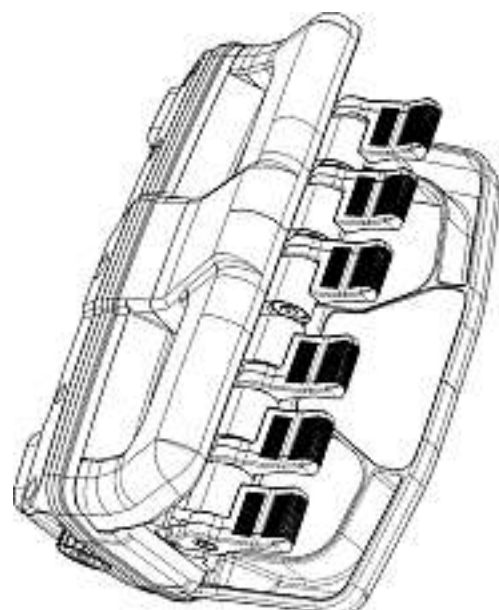
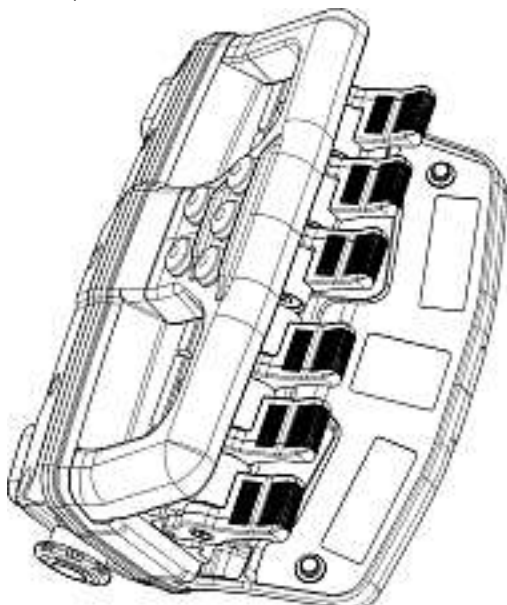
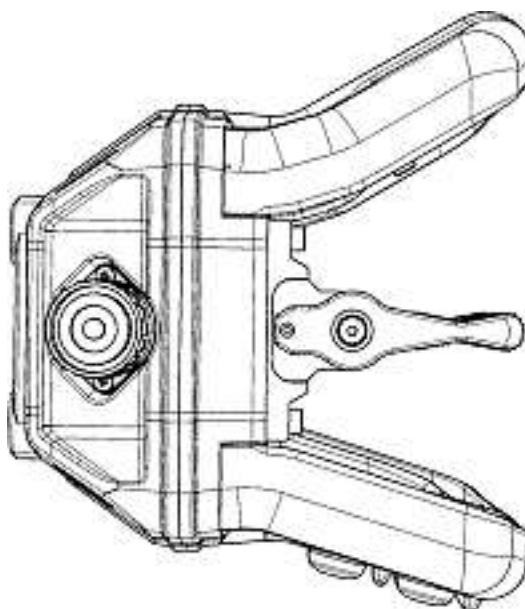
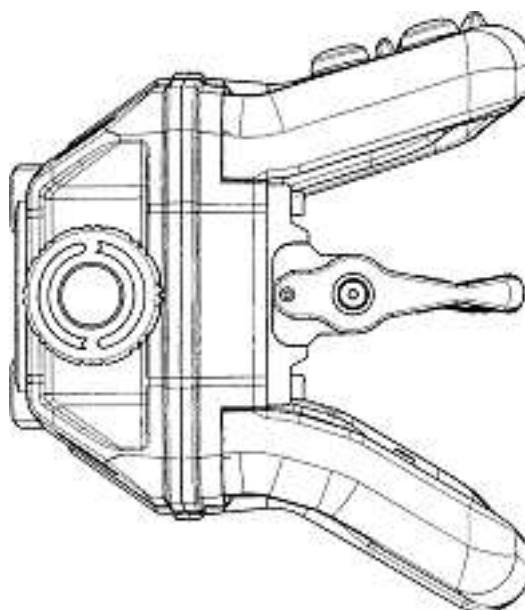

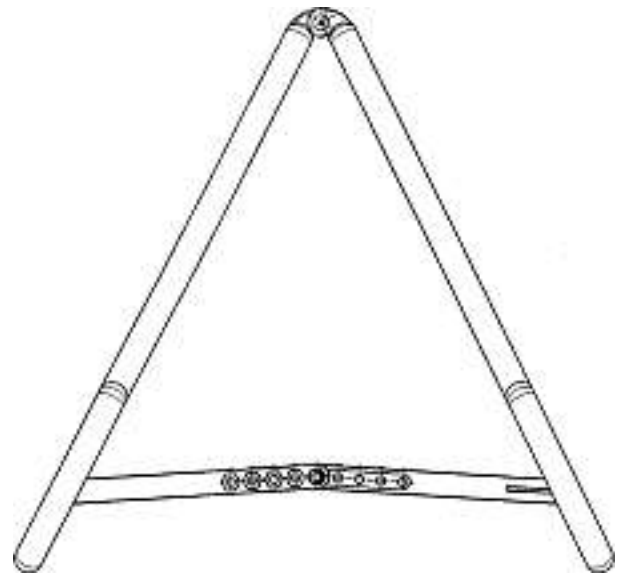
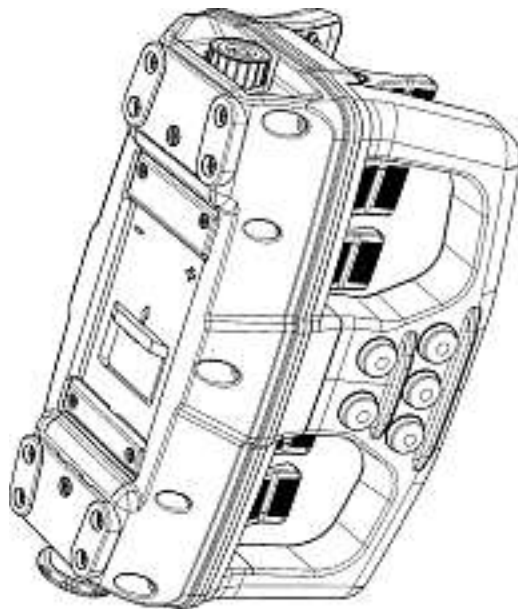
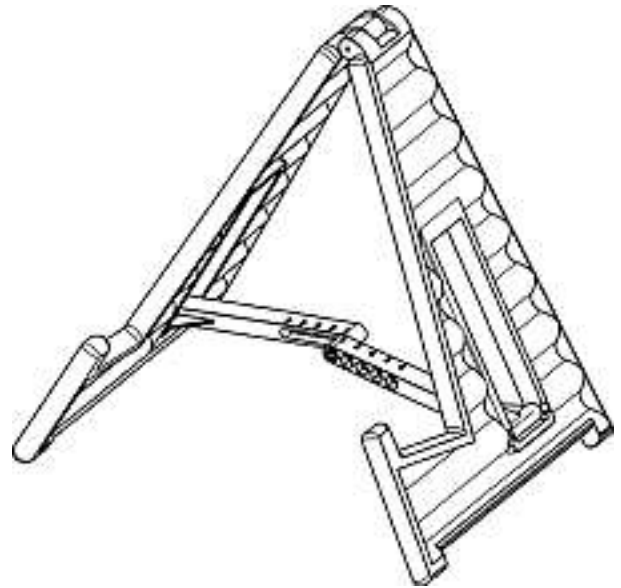
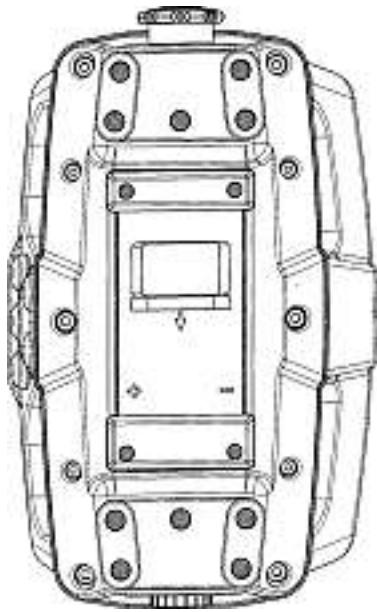

1

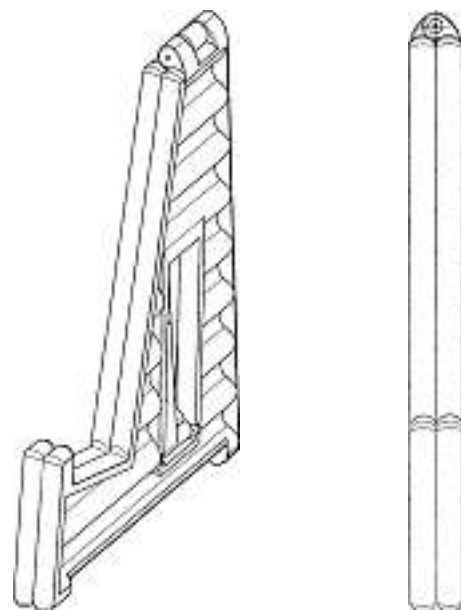

Cl. 17-99 **131 544** 11.03.2005
1 Design – Gitarrenständer
Hinterleger: König & Meyer GmbH & Co. KG, Kiesweg 2,
Wertheim, DE
Designer: Helmut Lippert, Breitenbrunn
Vertreter: Luchs & Partner, Patentanwälte, 8002 Zürich
Priorität: EM, 02.12.2004

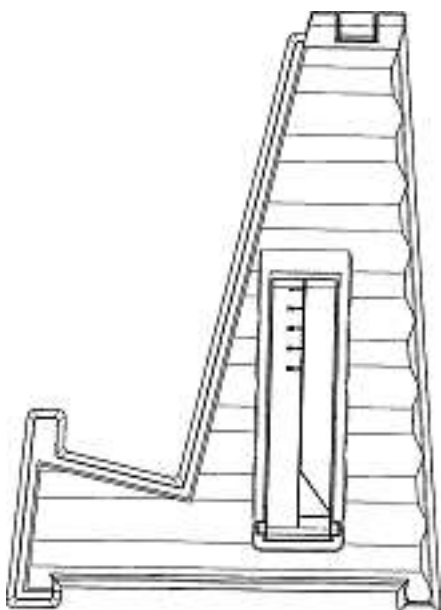

1

Cl. 19-07 131 545 24.01.2005

2 Design – Geografische Karten

Hinterleger: Mauro Piccighello, via Anello, 35/A, Sant'Angelo di Piove di Sacco (PD), IT; Nermin Banu Sarper, via Anello, 35/A, Sant'Angelo di Piove di Sacco (PD), IT

Vertreter: Riederer Hasler & Partner Patentanwälte AG, 7310 Bad Ragaz

Priorität: EM, 26.07.2004; EM, 26.07.2004



1



2

Cl. 19-08 131 546 24.02.2005

6 design – étiquettes

Déposant: Astra Tech AB, Aminogatan 1, 431 21 Mölndal, SE
Designer: Mattias Frenberg, Göteborg; Mikael Schultz, Lerum; Branko Schreurs, Göteborg

Mandataire: Novagraaf International SA, 1220 Les Avanchets

Priorité: EM, 03.09.2004

- 1 (siehe Farbteil Heftmitte)
- 2 (siehe Farbteil Heftmitte)
- 3 (siehe Farbteil Heftmitte)
- 4 (siehe Farbteil Heftmitte)
- 5 (siehe Farbteil Heftmitte)
- 6 (siehe Farbteil Heftmitte)

Cl. 19-99 131 547 31.01.2005

5 Design – CD-Ablagevorrichtung

Hinterleger: 3L-Ludvigsen A/S, Vibaekvej 100, Tommerup, DK

Designer: Bjarne Ludvigsen, Faaborg

Vertreter: A.W. Metz & Co. AG, 8024 Zürich

Priorität: EM, 24.01.2005

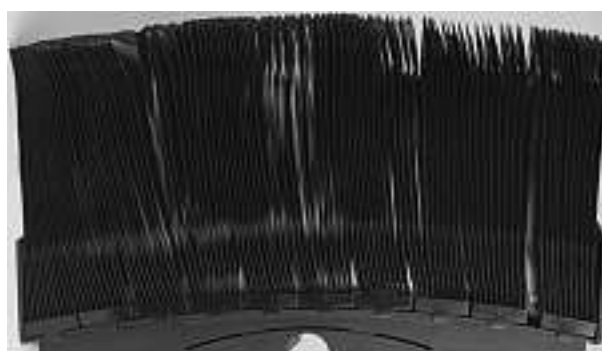
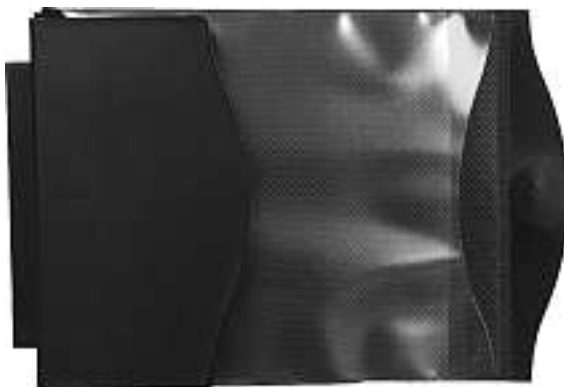



1



2





3

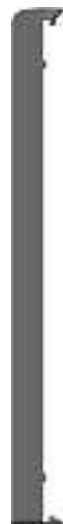

4



5

Cl. 20-02 131 548 18.01.2005
 1 Design – Verkaufstheke
 Hinterleger: Stefan Zachleder, Brauerstrasse 60, 8004 Zürich

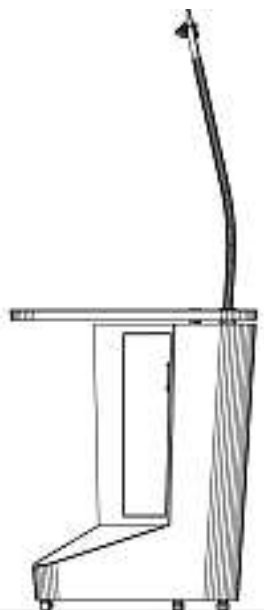
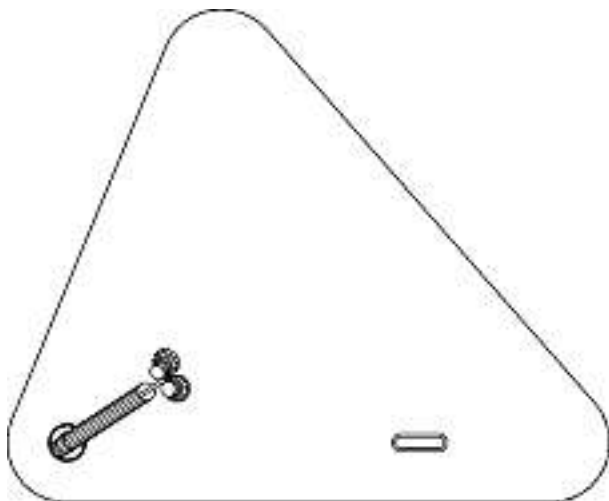

Salesdesk

Cl. 21-01 131 549 12.01.2005
 2 Design – Spiele
 Hinterleger: Paul Zehnder, Hänseleggen 5, 3226 Treiten

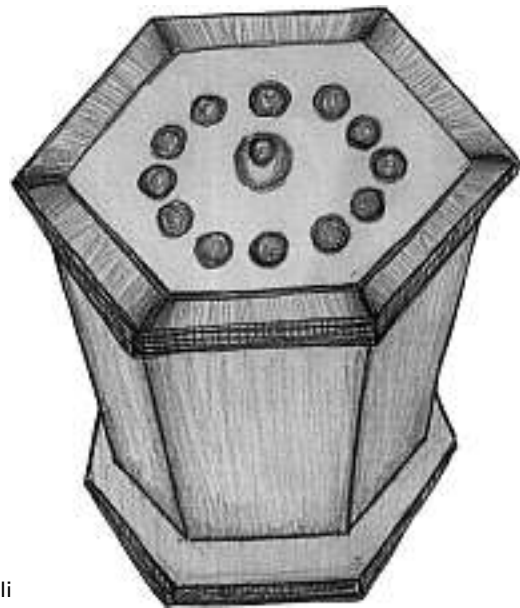

Zipoli

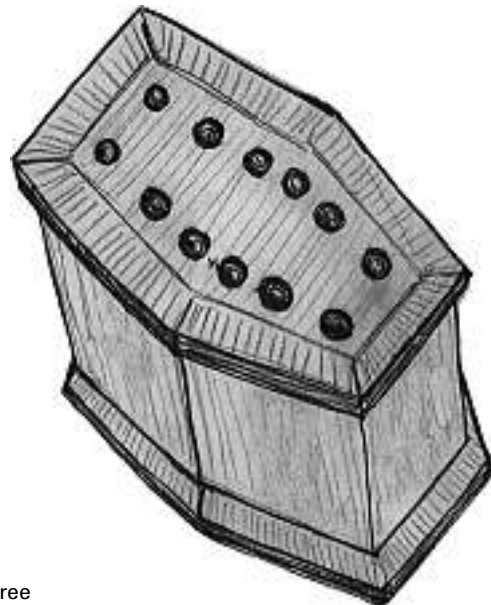

Poli-Free

Cl. 23-01, 23-02 131 550 09.02.2005
 7 Design – Armatur, Waschbecken, Badewannen, Ablauf
 Hinterleger: Spallo Kolb, Viscose 65, 9443 Widnau





001 Armatur



002 Waschbecken luisas mulde



003 Badewanne die Wanne



004 Waschbecken Sparta

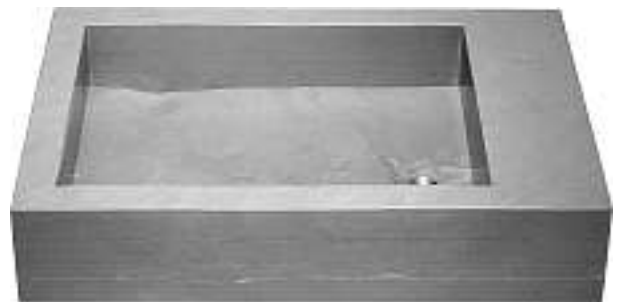

005 Waschbecken el fondo



006 Ablauf



007 Badewanne Japan

Cl. 23-99 131 551 09.03.2005
 10 Design – Display
 Hinterleger: TEM AG, Triststrasse 8, 7007 Chur
 Designer: Hans Saba, Tamins
 Vertreter: Schmauder & Partner AG, Patentanwälte VSP,
 8038 Zürich

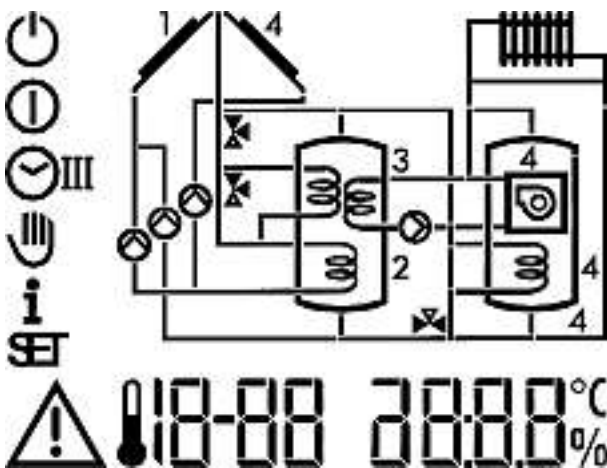

1

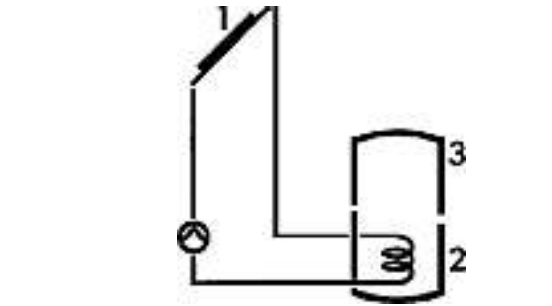

2

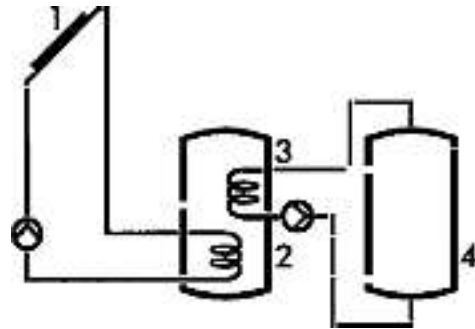

3

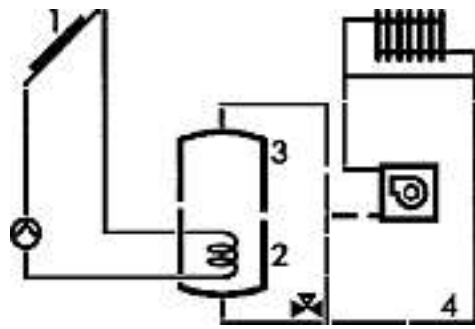

4

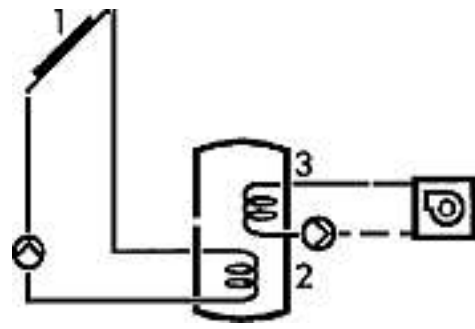

5

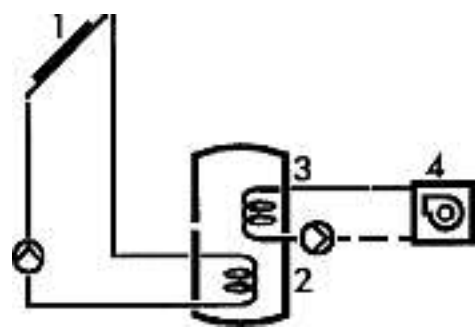

6

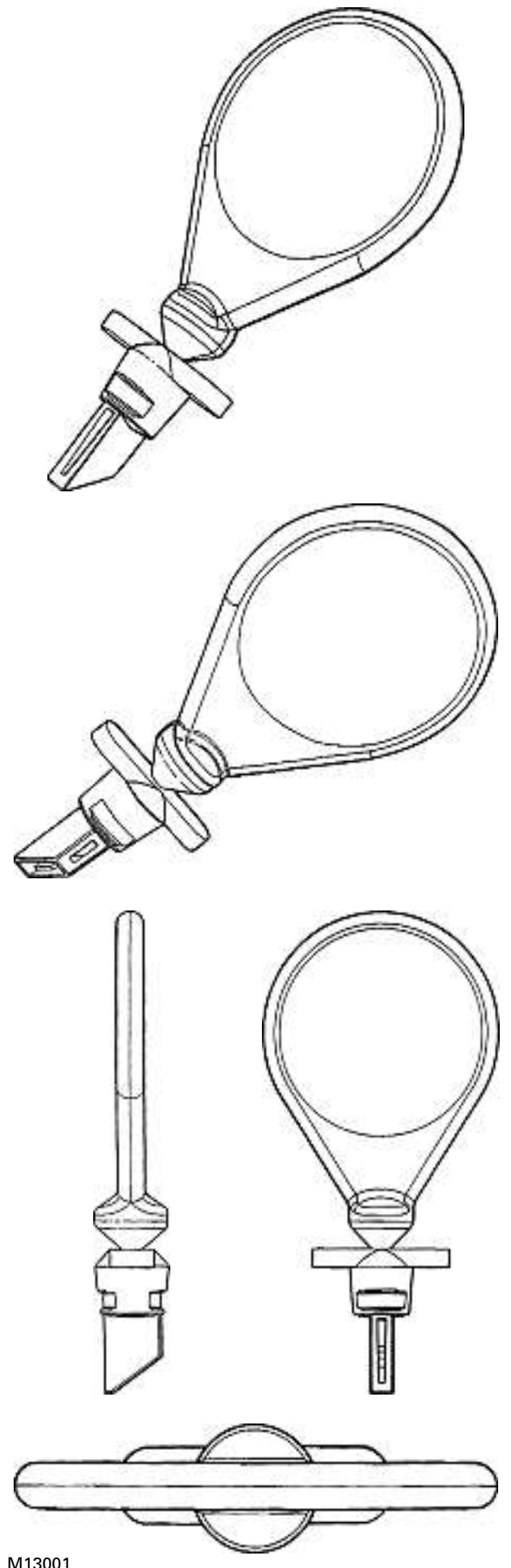
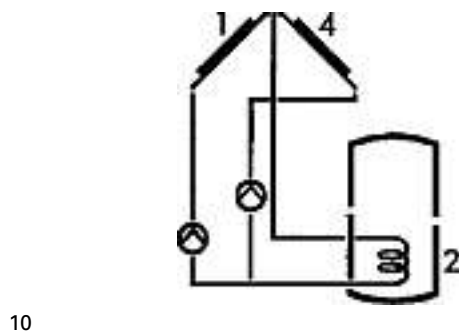
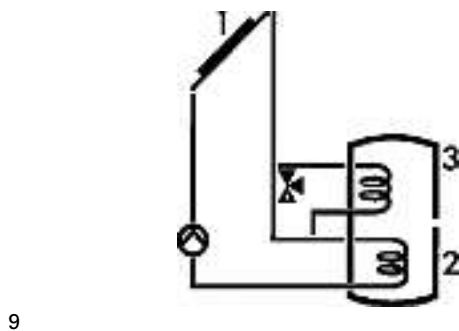
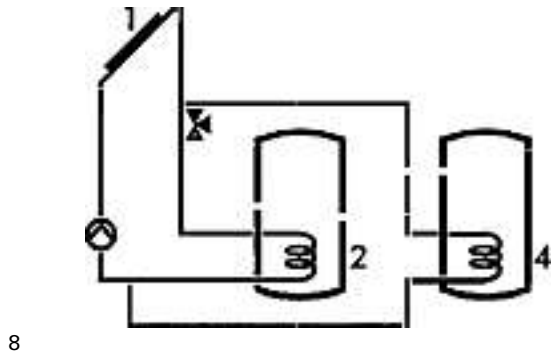
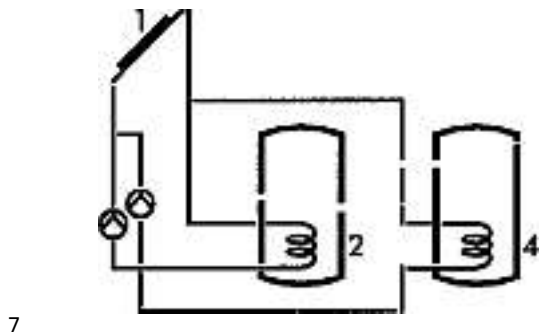

Cl. 24-02 131 552 11.02.2005
 1 Design – Kapillarrvorrichtung
 Hinterleger: Provalis Diagnostics Limited, Newtech Square,
 Deeside Industrial Park, Deeside, Flintshire CH5 2NT, GB
 Designer: David Alan Percival, Hawarden; Russell Bland,
 Leamington Spa
 Vertreter: Isler & Pedrazzini AG, 8023 Zürich
 Priorität: GB, 14.08.2004

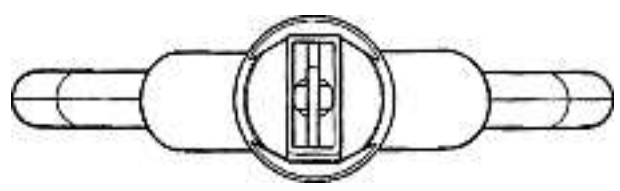

M13001

Cl. 24-02 131 553 03.03.2005
6 design – distributeur applicateur
Déposant: Closure Medical Corporation, 5250 Greens Dairy
Road, Raleigh (NC 27616), US
Designer: Eric J. Boone, St. Michael; Gardner J. Klaasen, Ada
Mandataire: Kirker & Cie S.A., Ingénieurs-Conseils,
1226 Genève - Thônex
Priorité: US, 03.09.2004

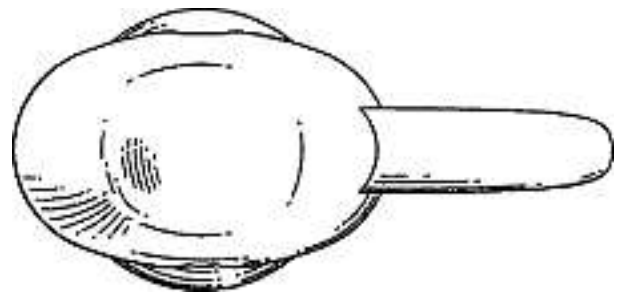

1

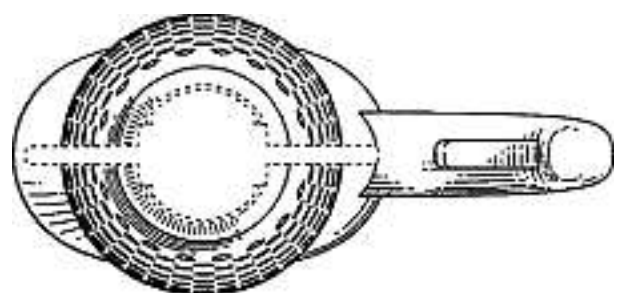
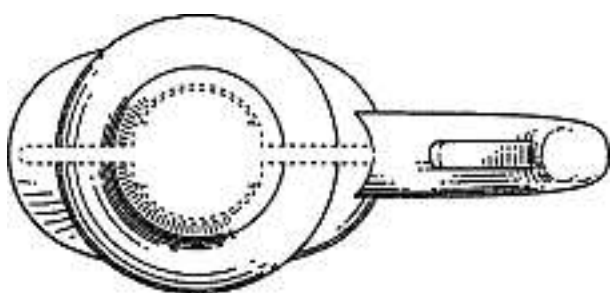
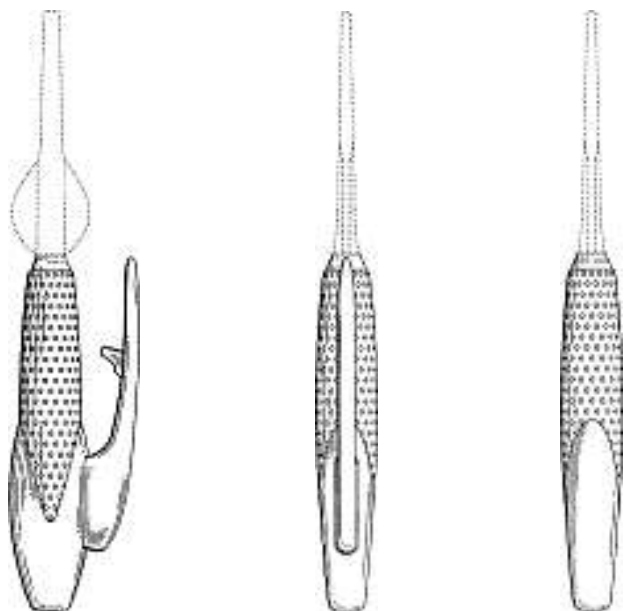
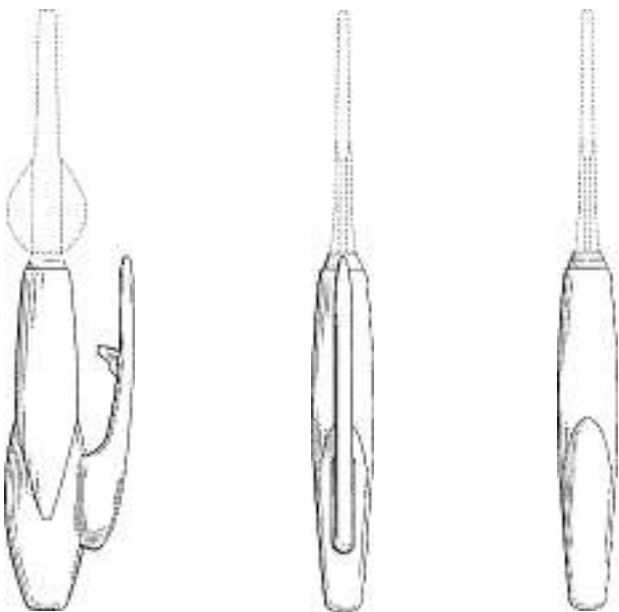
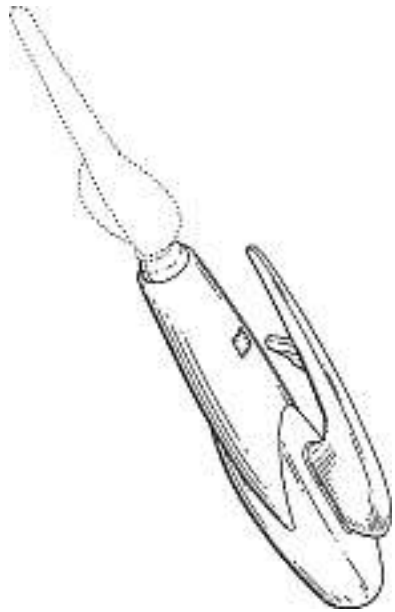

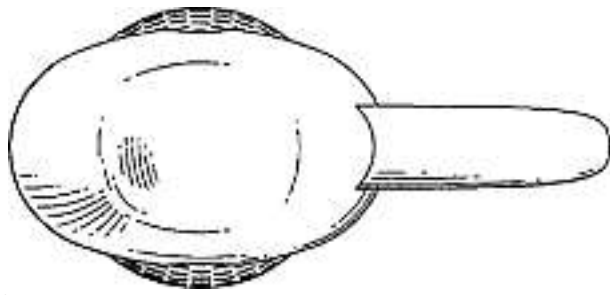

2

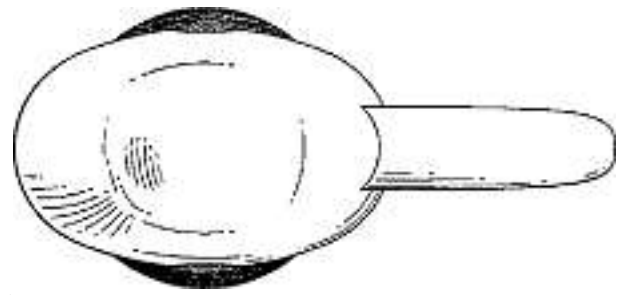

3

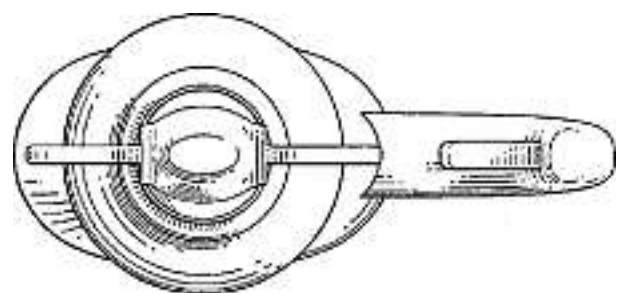
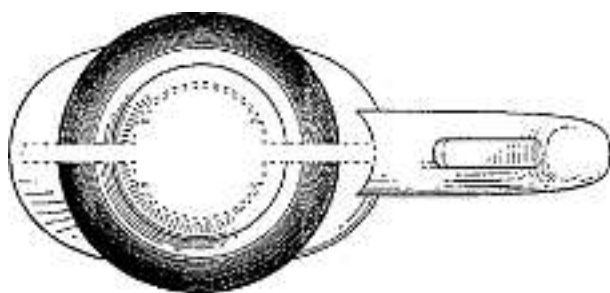
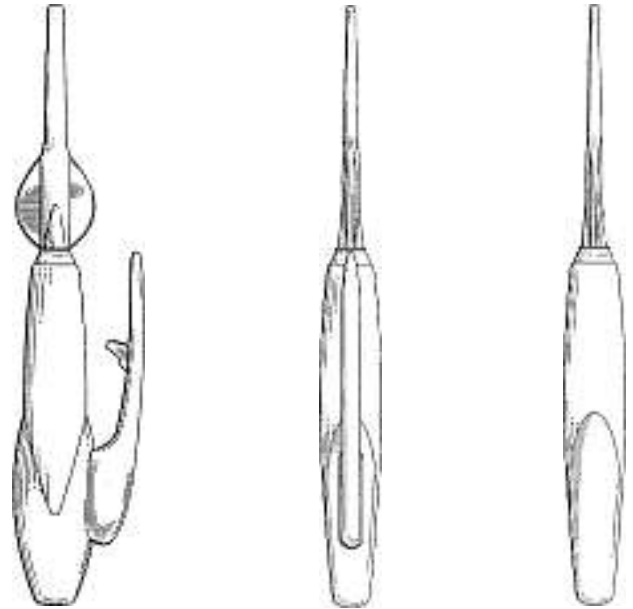
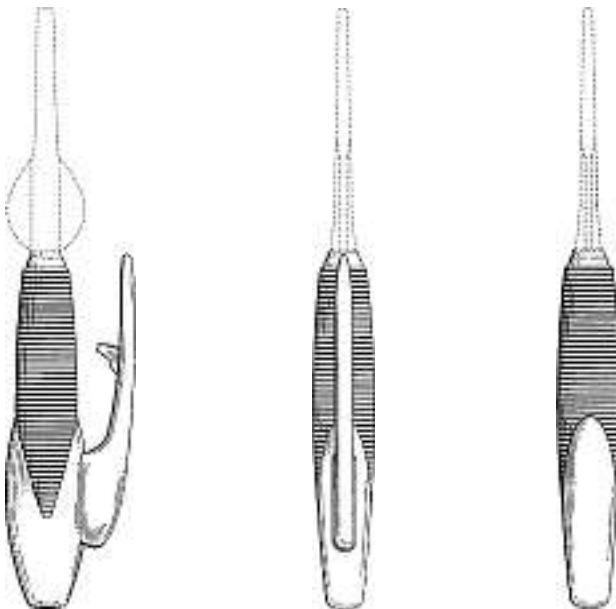
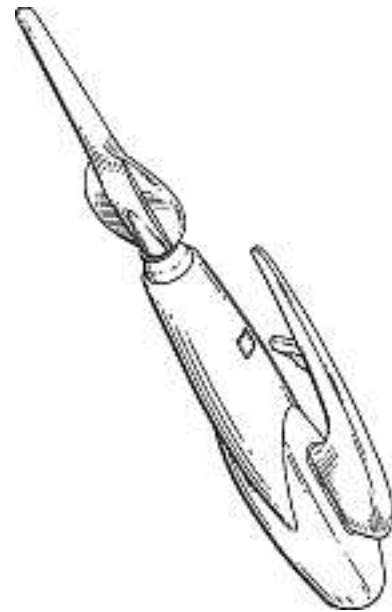
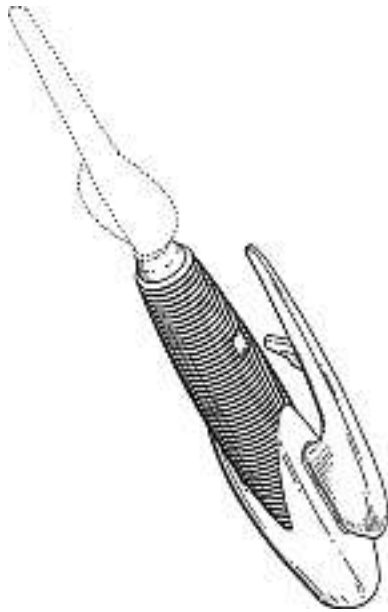

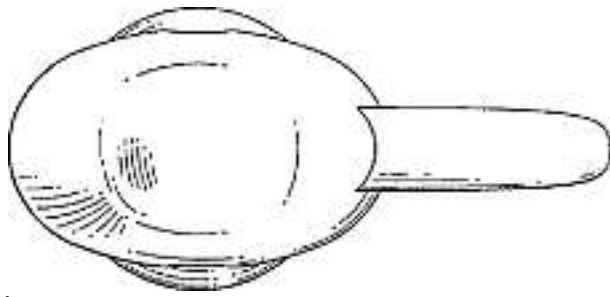

4

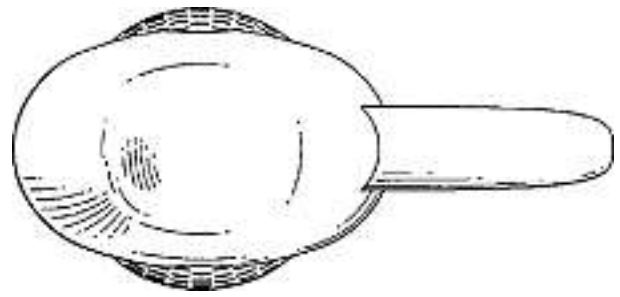

5

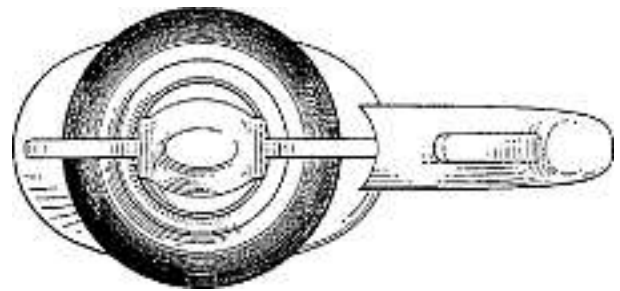
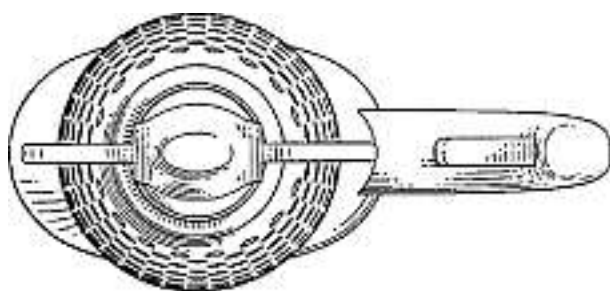
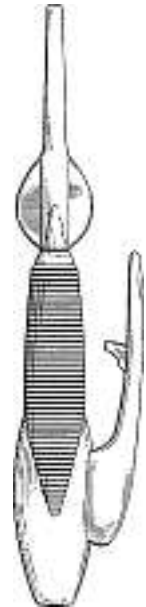
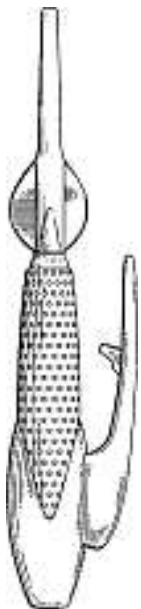
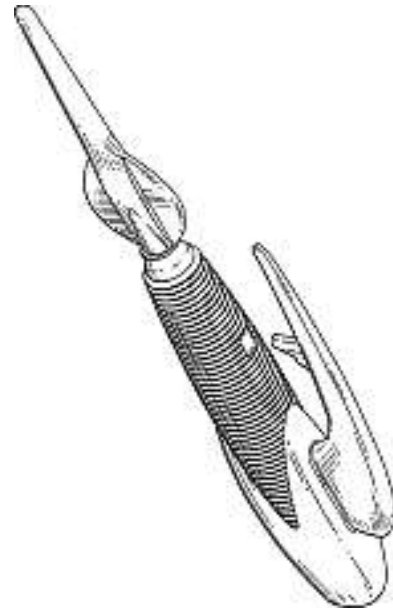
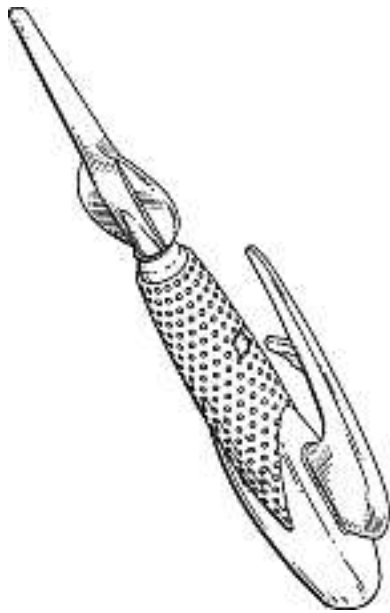

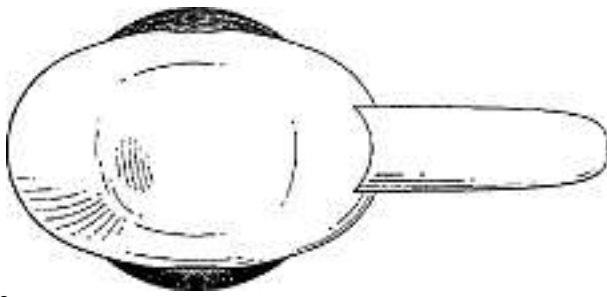

6



1

Cl. 24-03 **131 554** 10.03.2005
 1 Design – Prothesenteil
 Hinterleger: Arthrosearch (Pty) Ltd, 20 Golf Course Road,
 Sybrandpark, Rondebosch, Cape Town, ZA
 Designer: Pieter Johannes Botha, Krugersdorp
 Vertreter: A. Braun, Braun, Héritier, Eschmann AG,
 Patentanwälte, 4051 Basel
 Priorität: ZA, 17.09.2004

Cl. 25-01 **131 555** 21.02.2005
 2 design – profilé de construction
 Déposant: Litesteel Technologies Pty Ltd, 650 Lorimer Street,
 Port Melbourne, Victoria, AU
 Designer: Ross Ian Dempsey, Calamvale; Russell Lambert
 Watkins, Acacia Ridge
 Mandataire: Bugnion S.A., 1211 Genève 12 – Champel
 Priorité: AU, 03.09.2004; AU, 03.09.2004

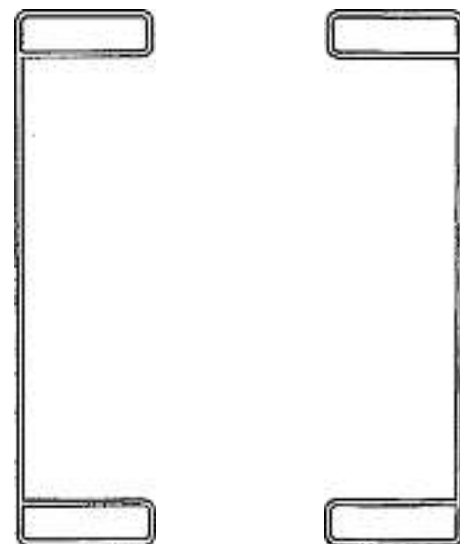
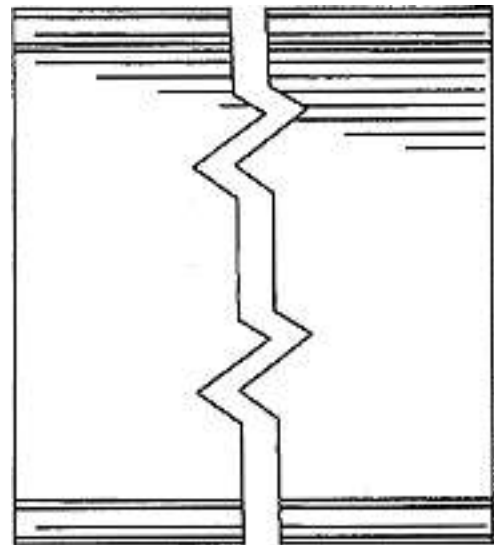

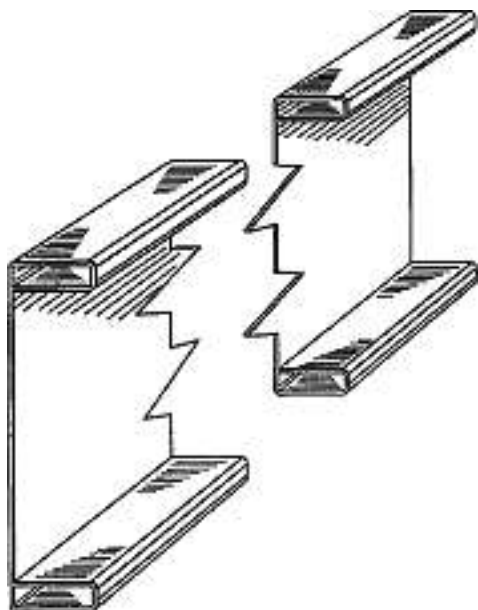
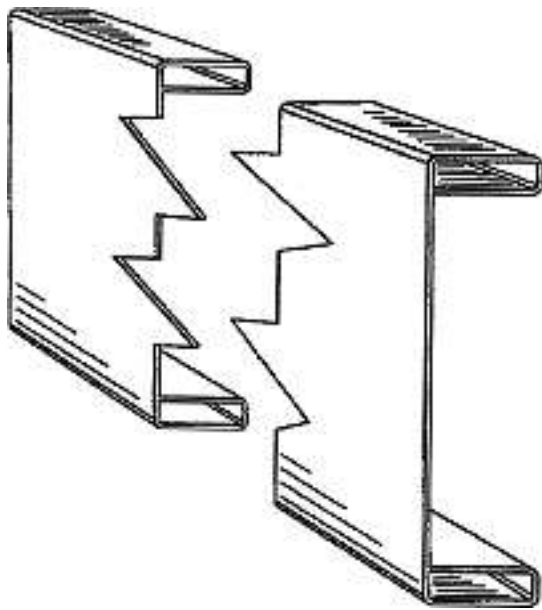
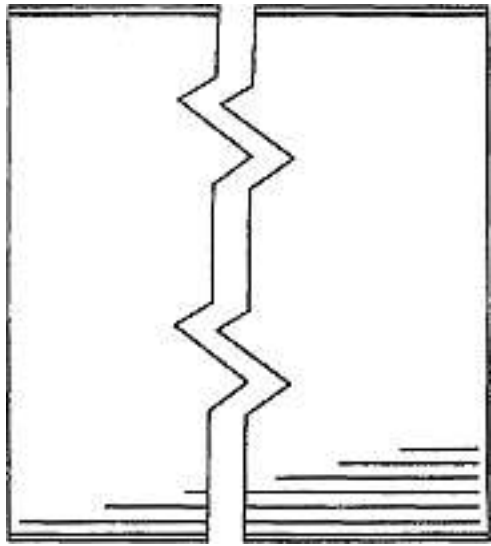

No 1

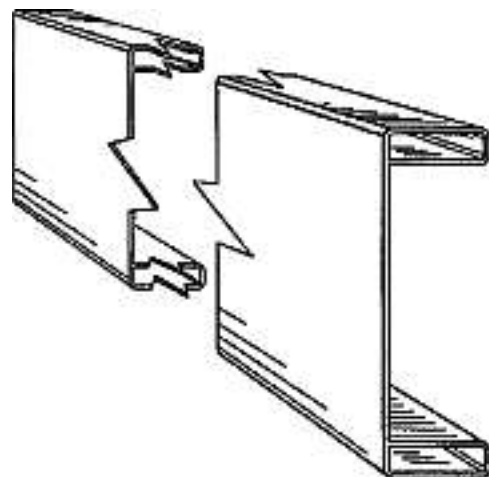
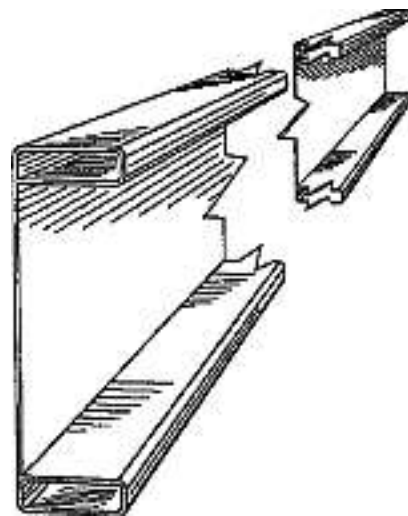
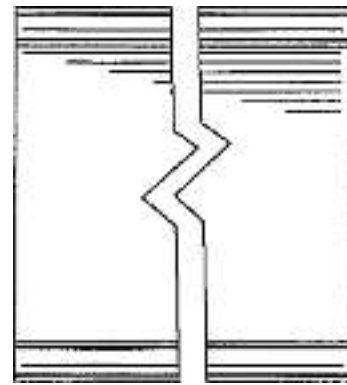

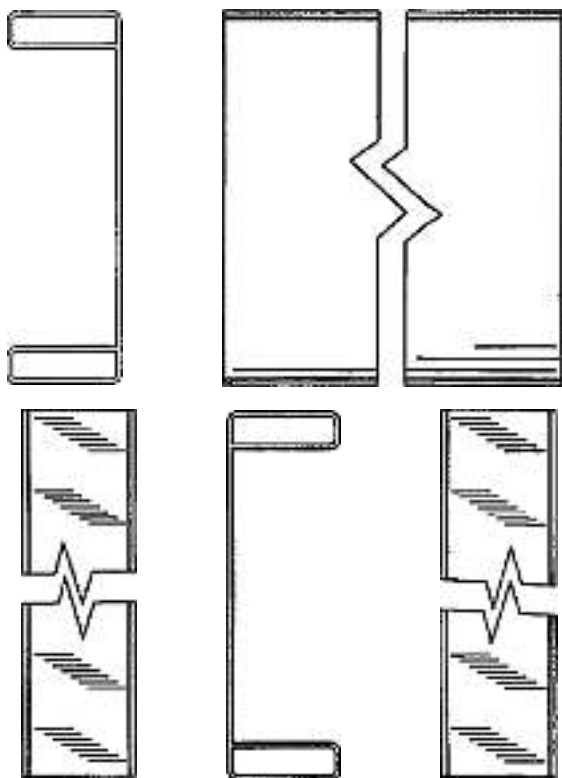

No 2

Cl. 26-05 131 556 09.02.2005
 1 Design – Lampe
 Hinterleger: Bruno Rupp, Belpstrasse 50, 3123 Belp

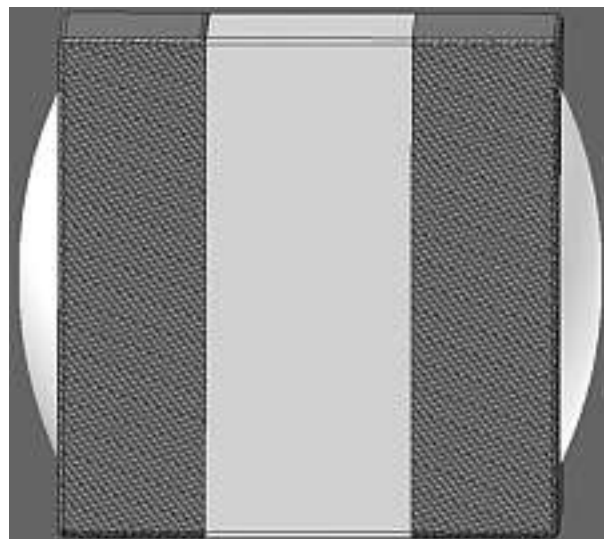
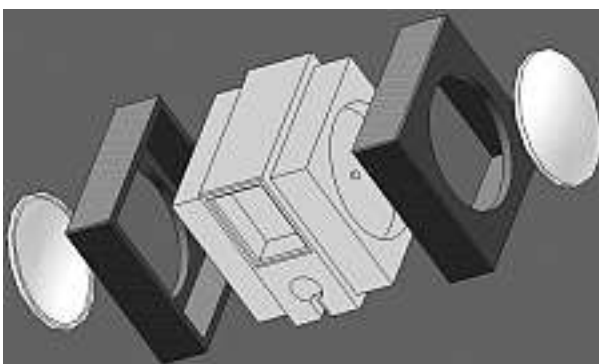
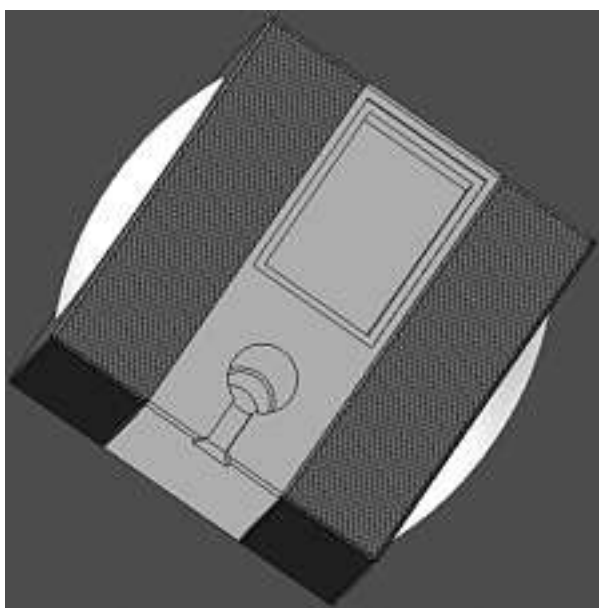

Touch Light

Cl. 26-05 131 557 30.03.2005
 2 Design – Leuchte
 Hinterleger: JO-EL-Electric A/S, Jorbaekvej 280, Odense, DK
 Designer: Anders Smith, Copenhagen
 Vertreter: Schmauder & Partner AG, Patentanwälte VSP, 8038 Zürich
 Priorität: DK, 21.01.2005

- 1 (siehe Farbteil Heftmitte)
- 2 (siehe Farbteil Heftmitte)

Cl. 28-03 131 558 17.03.2005
 2 design – appareils de massage
 Déposant: Visionart's, S.L., C/Santa Maria, 23 Bajo, Girona, ES
 Designer: Leandro Andres Cornaglia, Girona
 Mandataire: Kirker & Cie S.A., Ingénieurs-Conseils, 1226 Genève – Thônex

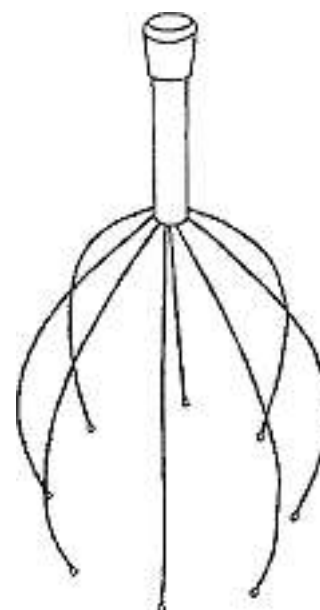

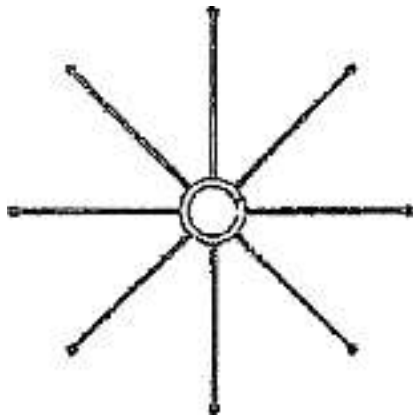
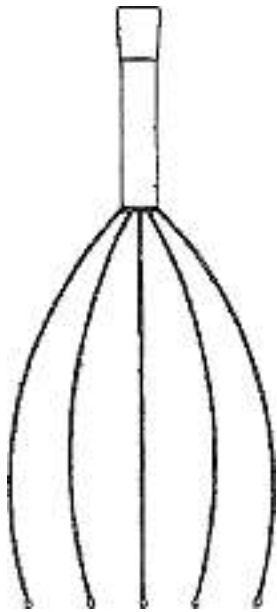

1

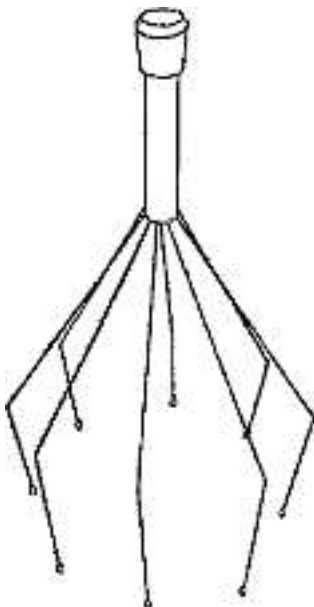

2

Cl. 29-02 131 559 24.01.2005
 1 Design – Seilhalter
 Hinterleger: Peter Baumgartner, Hauptstrasse 18,
 9403 Goldach



Clampe

Cl. 30-99 131 560 08.02.2005
 1 Design – Kauknochen
 Hinterleger: Mars, Incorporated, A Delaware Corporation,
 6885 Elm Street, McLean/VA, US
 Designer: Stewart M. Townsend, Yorba Linda; Tiffany Bierer,
 Fullerton; Kristin Boyle, Marina Del Ray; Jerry Franks,
 Placentia; Andrew Hinkle, Vernon; Steve McCauley, Yorba
 Linda; Alexandre Mendes, Redondo Beach; Emine Unlu,
 Pasadena
 Vertreter: A.W. Metz & Co. AG, 8024 Zürich
 Priorität: US, 12.10.2004

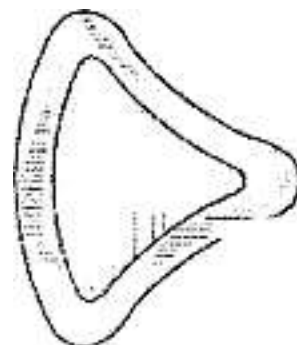
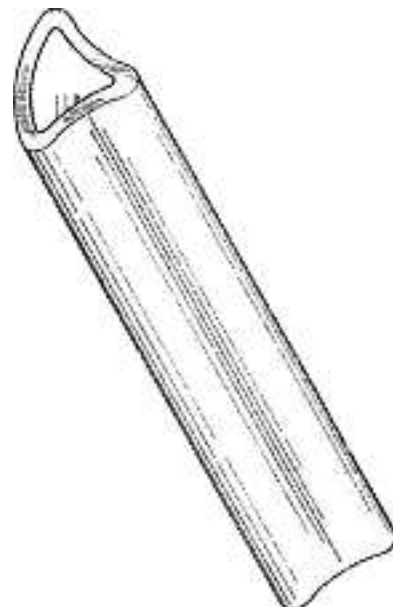

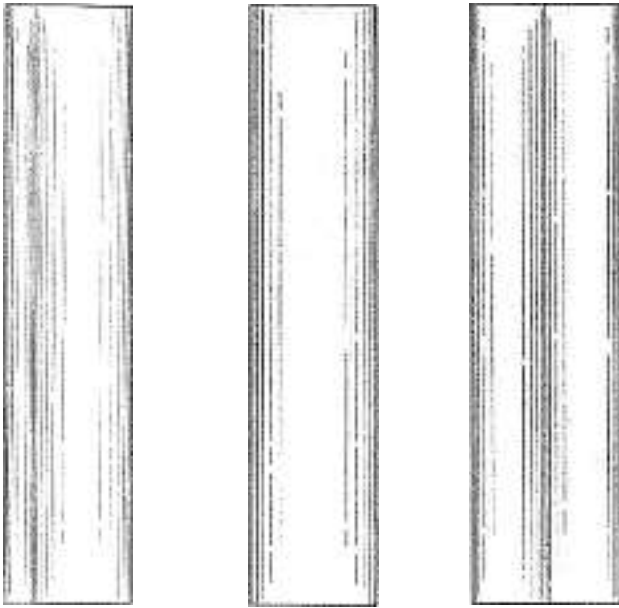

50896-CH/-DI

Cl. 99-00 **131 561** 07.03.2005
 1 Design – Leichentransportbehältnis
 Hinterleger: Starmed GmbH, Im Lehrer Feld 30, Ulm, DE
 Designer: René Stern, Ulm
 Vertreter: Riederer Hasler & Partner Patentanwälte AG,
 7310 Bad Ragaz
 Priorität: DE, 08.09.2004



1

**Verlängerungen
 Prolongations
 Prolongazioni**

118 096 Cl. 08-08 1 Design

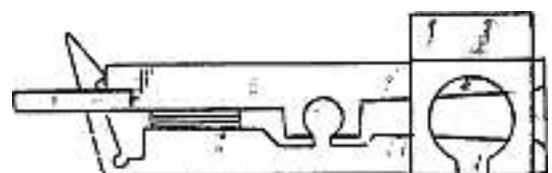
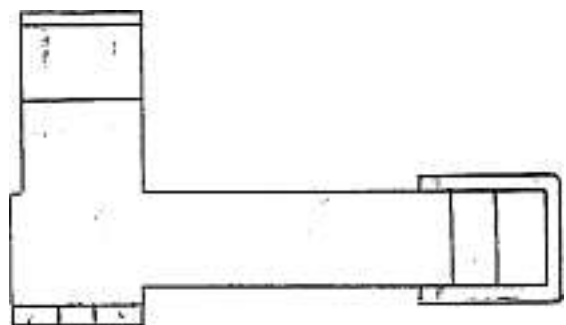
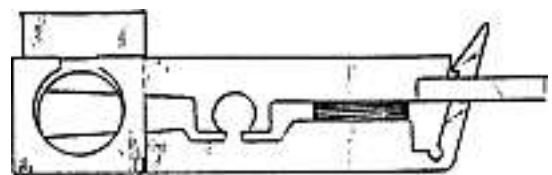
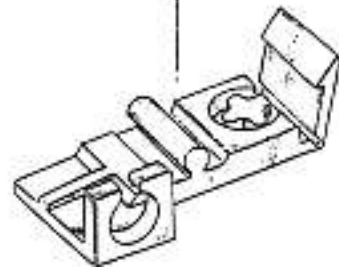
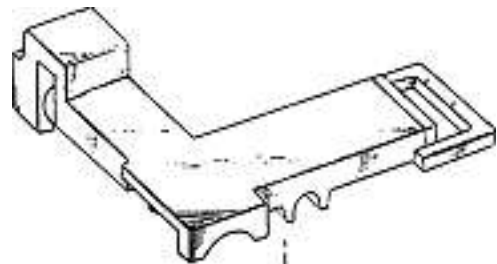
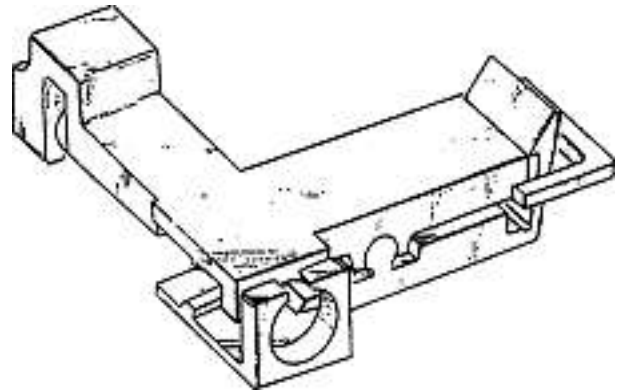

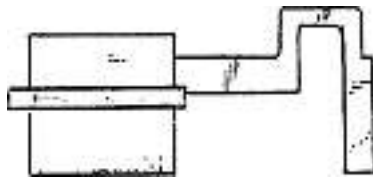
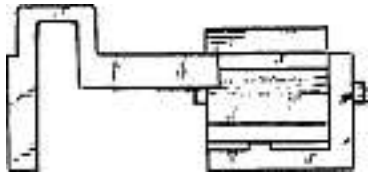
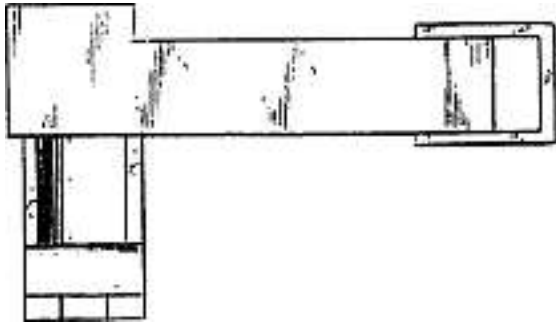

M 90/17

118 149 Cl. 12-15 1 design



274

118 479 Cl. 09-01 1 Design



1

122 151	Cl.	07-06	1 Design
122 213	Cl.	24-03	1 Design
122 319	Cl.	31-00	1 Design
122 333	Cl.	09-03	1 Design
122 502	Cl.	28-01	2 Design
126 383	Cl.	06-04	1 design
126 412	Cl.	07-99	1 Design
126 424	Cl.	12-11	1 Design
126 834	Cl.	26-02	3 Design
126 840	Cl.	11-03	60 Design
126 908	Cl.	23-02	1 Design
126 914	Cl.	25-01	4 Design
126 957	Cl.	24-04	1 Design
126 962	Cl.	28-01	2 Design
127 055	Cl.	09-03	1 Design
127 056	Cl.	09-03	1 Design
127 057	Cl.	09-03	1 Design
127 058	Cl.	09-03	1 Design
127 059	Cl.	09-03	1 Design
127 065	Cl.	12-15	1 Design
127 066	Cl.	12-15	2 Design
127 097	Cl.	04-02	1 Design
127 163	Cl.	20-02	1 Design
127 174	Cl.	29-02	1 design
127 194	Cl.	12-16	1 Design
127 356	Cl.	06-01	4 Design

Mutationen
Modifications
Modificazioni

120 646

122 554

122 878

123 347

Transmission

Déposant: Shell Brands International AG, Baarermatte,
6340 Baar

Mandataire: Kirker & Cie S.A., 1226 Genève-Thônex

121 071

121 072

121 073

125 679

125 680

Neuer Vertreter

Vertreter: Braunpat Braun Eder AG, 4015 Basel

124 188

Namensänderung

Hinterleger: Soda-Club Enterprises N.V., De Ruyterkade 62,
P.O. Box 812, Curaçao, AN

Vertreter: Hepp Wenger Ryffel AG, 9500 Wil SG

Löschungen
Radiations
Radiazioni

117 624	Cl.	03-01	2	Design
117 626	Cl.	06-01	2	Design
117 686	Cl.	14-03	6	Design
117 701	Cl.	23-02	1	Design
117 742	Cl.	06-03	3	Design
121 648	Cl.	10-02	1	design
121 682	Cl.	09-01	8	Design
121 685	Cl.	10-02	1	design
121 696	Cl.	21-01	1	Design
121 700	Cl.	23-02	1	design
121 702	Cl.	26-04	1	Design
121 732	Cl.	12-16	3	Design
126 338	Cl.	06-01	1	Design
126 339	Cl.	06-01	1	Design
126 352	Cl.	11-01	14	Design
126 358	Cl.	13-03	1	Design
126 359	Cl.	13-03	2	Design
126 364	Cl.	14-02	1	Design
126 366	Cl.	14-03	1	design
126 368	Cl.	18-03	2	Design
126 369	Cl.	19-03	1	design
126 372	Cl.	20-02	1	design
126 380	Cl.	03-01	4	Design
126 384	Cl.	06-04	4	Design
126 385	Cl.	06-11	40	Design
126 389	Cl.	10-02	19	Design
126 391	Cl.	10-07	1	design
126 393	Cl.	11-01	23	design
126 395	Cl.	19-04	1	Design
126 431	Cl.	20-02	1	design
126 433	Cl.	21-01	1	design
126 442	Cl.	06-01	15	Design
126 478	Cl.	28-03	1	design

Cl. 05-05

129 167

26.11.2002



No. 1

Cl. 08-09

131 516

21.12.2004



1



2



5



6



7



8



3



4



9



10



11



12



17



18



13



14



19



20



15



16



21



22



23



24



29



30



25



26



31



32



27



28



33



34



35



36



4

Cl. 09-03

131 522

04.01.2005

Cesar

1



2



3



5



6



7



8



9



10



11

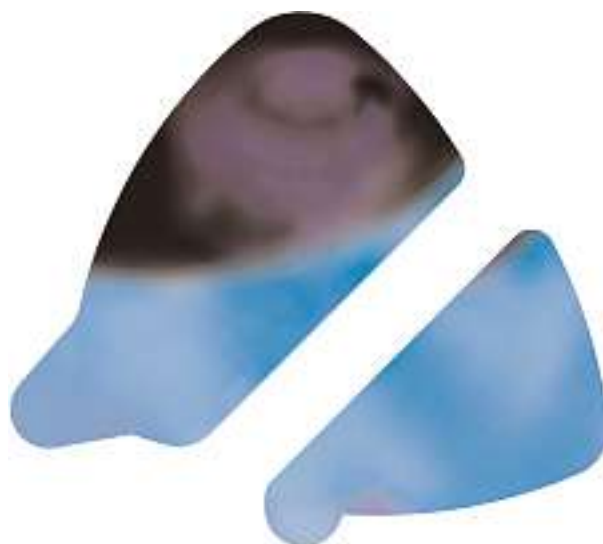

12



13



14



15



18

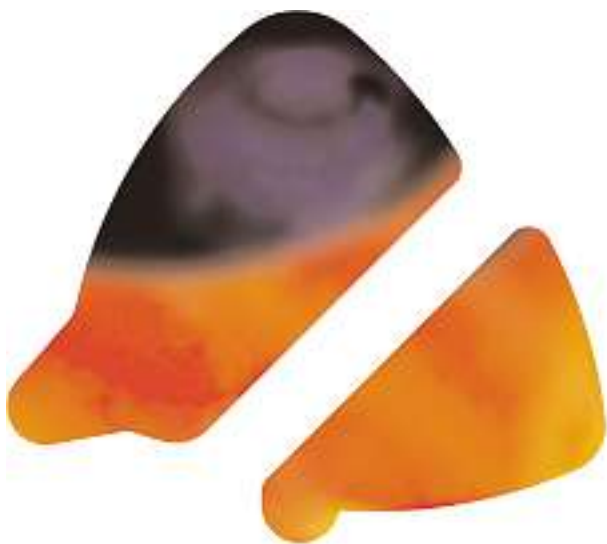

16



19

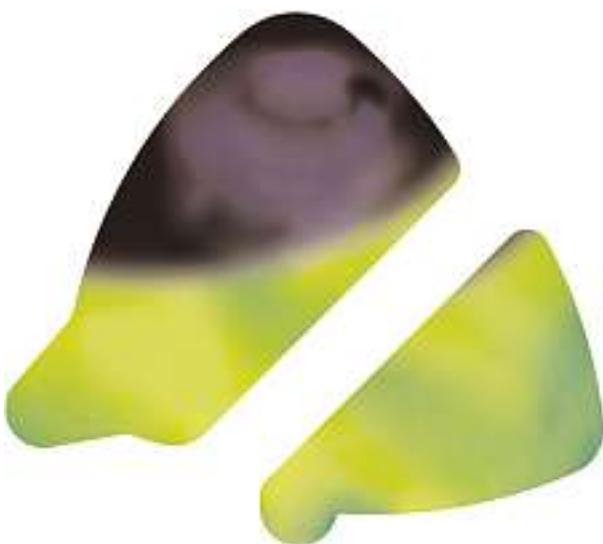

17

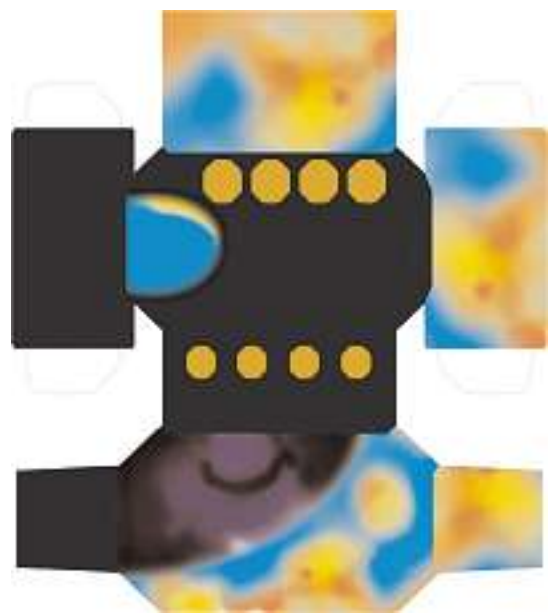

20

Cl. 19-08

131 546

24.02.2005

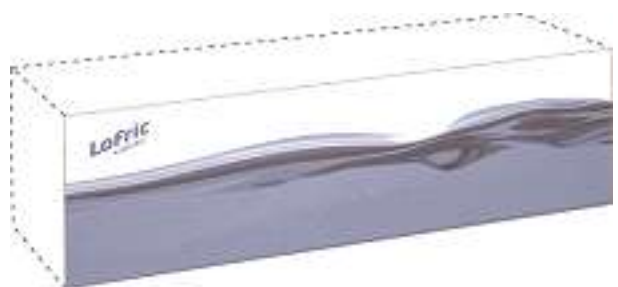



1

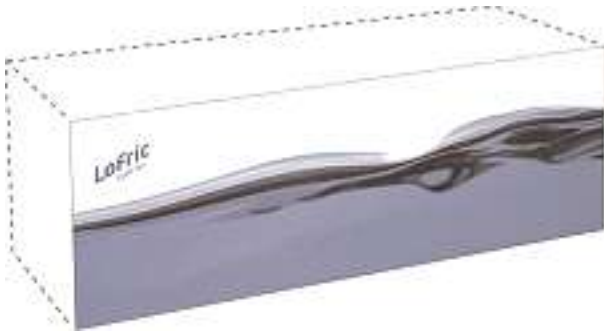

2

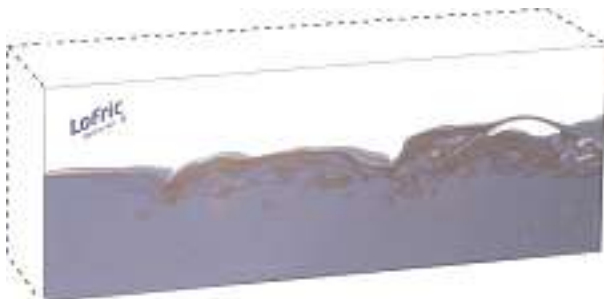

3



4

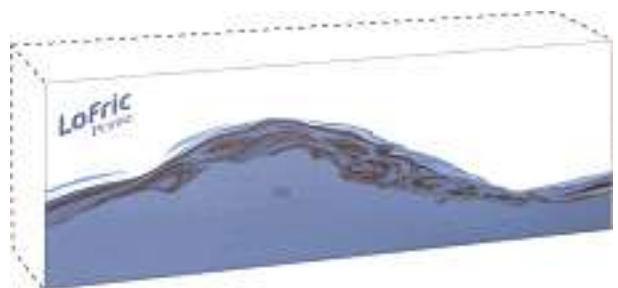

5

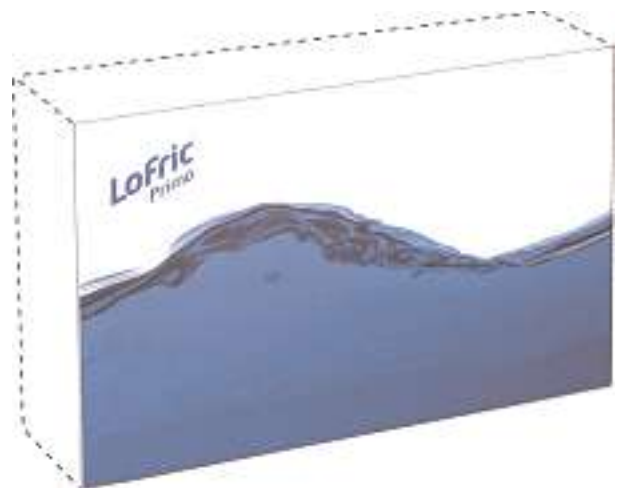

6

Cl. 26-05

131 557

30.03.2005



1



2

