

Nationale Hinterlegungen

In der folgenden Liste werden die beim Eidgenössischen Institut für Geistiges Eigentum hinterlegten Designs publiziert. Dabei sind der Reihe nach angegeben:

- internationale Klassenangaben
- Hinterlegungsnummer
- Hinterlegungsdatum
- Allenfalls Aufschub der Veröffentlichung
- Anzahl der hinterlegten Designs
- Bezeichnung
- Name und Wohnsitz des Hinterlegers oder der Hinterlegerin
- gegebenenfalls Name und Wohnsitz des Designers oder der Designerin
- Name und Geschäftssitz des allfälligen Vertreters oder der Vertreterin
- gegebenenfalls Prioritätsangaben
- gegebenenfalls Beschreibungstext
- Ordnungsnummer
- Reproduktion des Designs

Internationale Hinterlegungen

Die bei der Weltorganisation für geistiges Eigentum in Genf hinterlegten Muster und Modelle mit Benennung Schweiz geniessen den gleichen Schutz wie national hinterlegte Designs. Sie werden jeweils im Blatt «Bulletin des dessins et modèles internationaux» veröffentlicht. Dieses Publikationsorgan ist deshalb für eine vollständige Recherche unbedingt beizuziehen.

Topographien

Angaben über die vom Eidgenössischen Institut für Geistiges Eigentum eingetragenen Topographien von Halbleitererzeugnissen werden in folgender Anordnung aufgeführt:

- Eintragsnummer
- Anmeldedatum
- Bezeichnung
- Name und Wohnsitz des Anmelders oder der Anmelderin
- gegebenenfalls Name und Wohnsitz des Herstellers oder der Herstellerin
- Name und Geschäftssitz des oder der allfälligen Bevollmächtigten
- Datum und Ort einer allfälligen ersten geschäftlichen Verbreitung der Topographie

Dépôts nationaux

Les designs déposés à l'Institut Fédéral de la Propriété Intellectuelle sont publiés dans la liste qui suit. Les indications y relatives sont mentionnées dans cet ordre:

- indications des classes internationales
- numéro de dépôt
- date de dépôt
- le cas échéant, ajournement de la publication
- nombre des designs déposés
- désignation
- nom et domicile du/de la déposant/e
- le cas échéant, nom et domicile du/de la designer
- nom et domicile de l'éventuel/le mandataire
- le cas échéant, indication de priorité
- le cas échéant, description du design
- numéro attribué à chaque design
- reproduction du design

Dépôts internationaux

Les dessins et modèles déposés à l'Organisation Mondiale de la Propriété Intellectuelle à Genève qui désignent la Suisse jouissent de la même protection que les dépôts nationaux. Ils sont chaque fois publiés dans la feuille «Bulletin des dessins et modèles internationaux». Pour une recherche complète, il est indispensable de consulter ledit organe de publication.

Topographies

Les indications concernant les topographies des produits semi-conducteurs, enregistrées par l'Institut Fédéral de la Propriété Intellectuelle, sont énumérées dans l'ordre suivant:

- numéro d'enregistrement
- date de dépôt
- désignation
- nom et domicile du/de la déposant/e
- le cas échéant, nom et domicile du/de la producteur/trice
- nom et domicile de l'éventuel/le mandataire
- date et lieu d'une éventuelle première mise en circulation de la topographie

Depositi nazionali

Nella lista seguente vengono pubblicati i design depositati presso l'Istituto Federale della Proprietà Intellettuale. Sono menzionati nel seguente ordine:

- indicazioni delle classi internazionali
- numero di deposito
- data del deposito
- se del caso, indicazione che la pubblicazione è stata differita
- numero dei design depositati
- designazione
- nome e domicilio del depositante
- se del caso, nome e domicilio del designer
- nome e sede di un eventuale mandataro
- se del caso, indicazioni di priorità
- se del caso, descrizione del design
- numero d'ordine
- riproduzione del design

Depositi internazionali

I disegni e modelli depositati presso l'Organizzazione Mondiale della Proprietà Intellettuale a Ginevra con denominazione Svizzera godono della medesima protezione del deposito nazionale. Essi vengono pubblicati ogni volta nel foglio «Bulletin des dessins et modèles internationaux». Quest'organo di pubblicazione è da consultare se si vuole effettuare una ricerca completa.

Topografie

Le indicazioni concernenti le topografie di prodotti a semiconduttori depositati presso l'Istituto Federale della Proprietà Intellettuale sono menzionate nell'ordine seguente:

- numero di registrazione
- data del deposito
- designazione
- nome e domicilio del/la richiedente
- se del caso, nome e domicilio del/la produttore/trice
- nome e sede di un eventuale mandataro
- data e luogo di un'eventuale prima messa in circolazione della topografia

Hinterlegungen Dépôts Deposit

Cl. 03-04 129 904 11.09.2003
5 Design – Fächer
Hinterleger: Marisa Alcayde, Haldenstrasse 51a, 6006 Luzern

Ende aufgeschobene Publikation

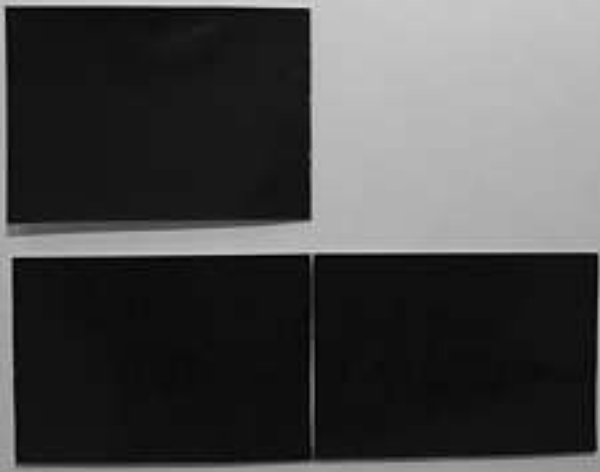

1



2



3

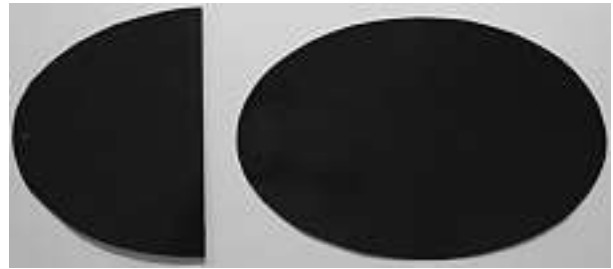

4



5

Cl. 12-12 129 936 16.09.2003
1 Design – Rollstuhl
Hinterleger: Invacare AG, Ringstrasse 15, 4123 Allschwil
Designer: Rainer Kuschall, Allschwil
Vertreter: OK pat AG, 6300 Zug

Ende aufgeschobene Publikation





K0537D-CH



Cl. 09-05 **130 042** 25.09.2003

1 Design – Beutelpackung

Hinterleger: Brian Kevin Fries, Hopfenstrasse 18, 8045 Zürich,

Andreas Bechtiger, Bucheggstrasse 43, 8037 Zürich

Vertreter: Andreas Bechtiger, 8037 Zürich

Ende aufgeschobene Publikation





Sirupperle

Cl. 06-01 130 074 17.10.2003

1 design – tabouret

Déposant: Christian Dupraz, rue Dancet 3, 1205 Genève

Fin de la période ajournement de la publication



1

Cl. 20-02 130 111 07.11.2003

2 Design – Stütze

Hinterleger: Bruno Messerli, Moosacker 134, 4587 Aetingen

Ende aufgeschobene Publikation

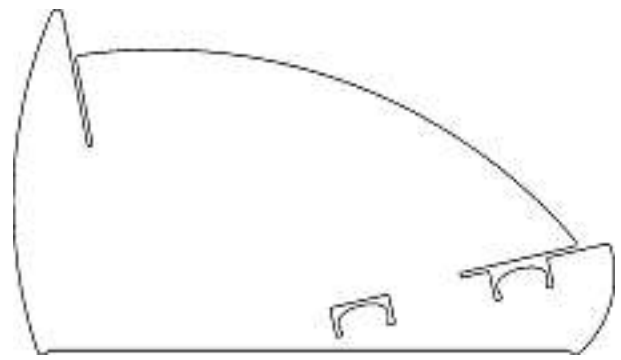

Dispenserstütze 1

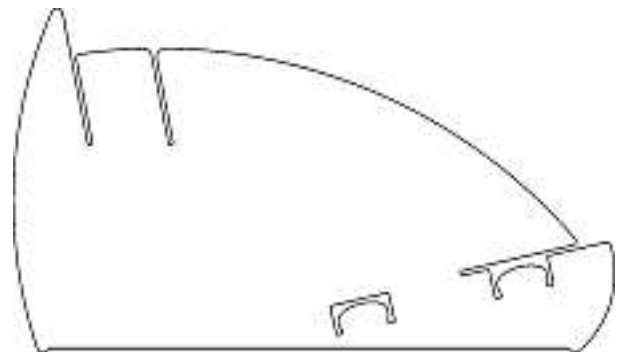

Dispenserstütze 2

Cl. 11-01 130 214 07.11.2003

55 Design – Ringe

Hinterleger: Furrer-Jacot AG, Feldstrasse 30,

8201 Schaffhausen

Designer: Lucas Ruppli, Schaffhausen

Ende aufgeschobene Publikation



71-81500



71-25500



71-81520



71-81510



71-25520



71-25510



71-81530



71-25530



71-81570



71-81540



71-25570



71-25540



71-81580



71-25580



71-81620



71-81590



71-25620



71-25590



71-81630



71-25630



71-81650



71-81640



71-25650



71-25640



71-81660



71-25660



71-25680



71-81670



71-81690



71-25670



71-25690



71-81680



71-81720



71-25730



71-25720



71-81740



71-81730



71-25740



71-81750



71-25760



71-25750



71-81770



71-81760



71-25770



62-52210



71-26220



71-26210



62-52230



62-52220



71-26230



62-52240



71-26250



71-26240



53-66070



62-52250

Cl. 12-08 **130 406** 15.03.2004

1 design – autovettura

Depositante: Honda Motor Co., Ltd., No. 1-1, 2-chome, Minami-aoyama, Minato-ku, Tokyo, JP

Designer: Akio Fumiiri, Saitama; Nobuyuki Takahashi, Saitama

Mandatario: Fiammenghi-Fiammenghi, 6900 Lugano

Priorità: JP, 22.09.2003

Fine del periodo di differimento della pubblicazione

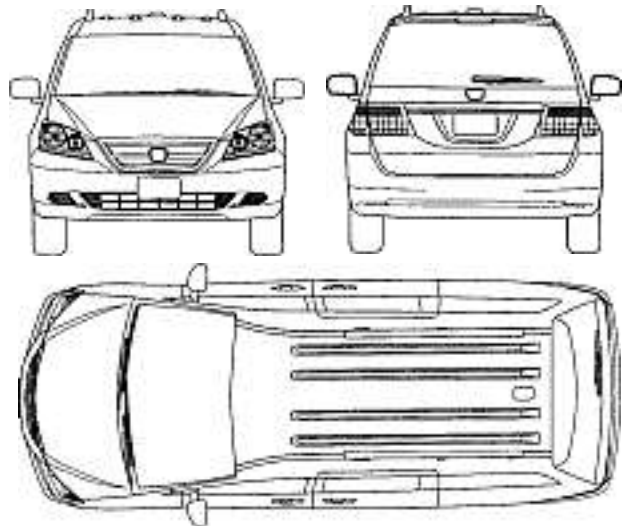

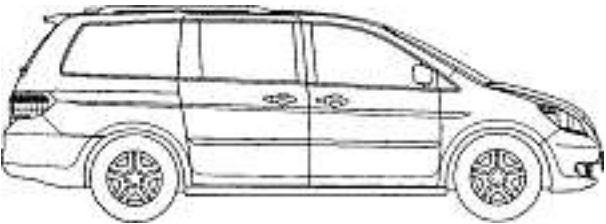
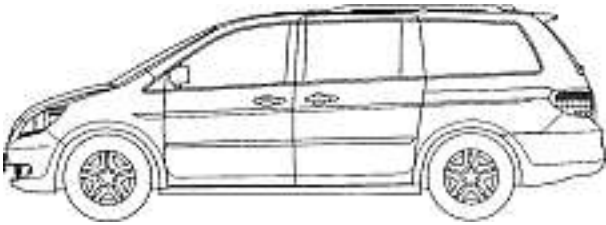
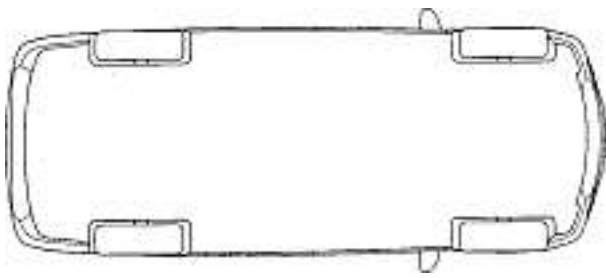

431

Cl. 26-06 **130 416** 15.03.2004

1 design – gruppo ottico anteriore per autovettura
 Depositante: Honda Motor Co., Ltd., No. 1-1, 2-chome,
 Minami-aoyama, Minato-ku, Tokyo, JP
 Designer: Takashi Nagura, Saitama; Masanori Tokutani,
 Saitama

Mandatario: Fiammenghi-Fiammenghi, 6900 Lugano

Priorità: JP, 22.09.2003

Fine del periodo di differimento della pubblicazione

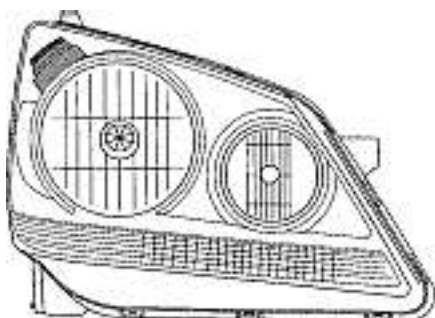
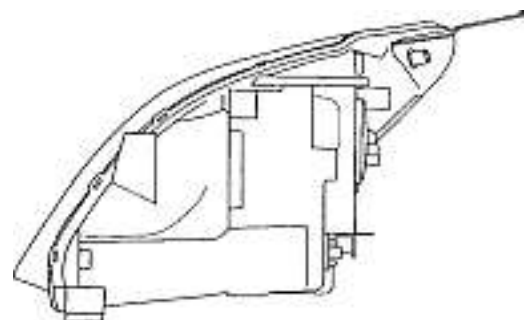
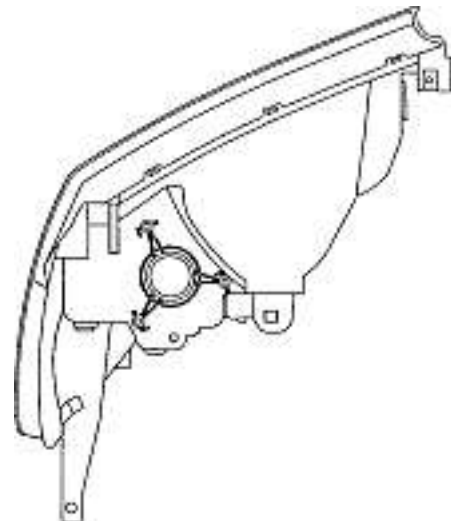
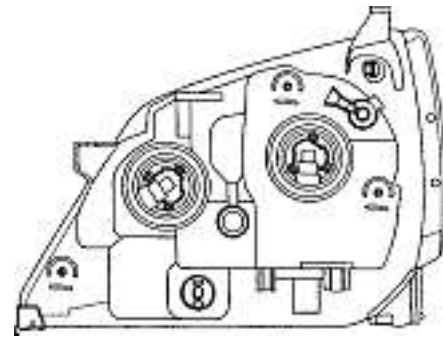

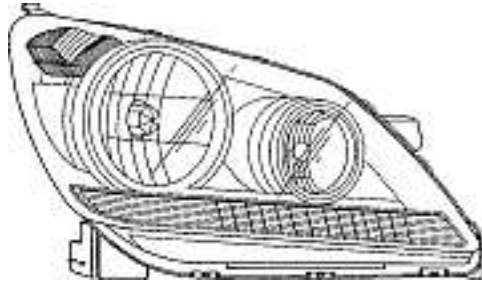
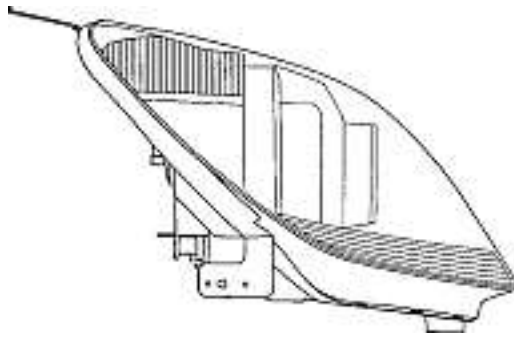

432

Cl. 26-06 **130 417** 15.03.2004
 1 design – gruppo ottico posteriore per autovettura
 Depositante: Honda Motor Co., Ltd., No. 1-1, 2-chome,
 Minami-aoyama, Minato-ku, Tokyo, JP
 Designer: Tadahiro Kamimura, Saitama; Hajime Maniwa,
 Saitama
 Mandatario: Fiammenghi-Fiammenghi, 6900 Lugano
 Priorità: JP, 22.09.2003
 Fine del periodo di differimento della pubblicazione

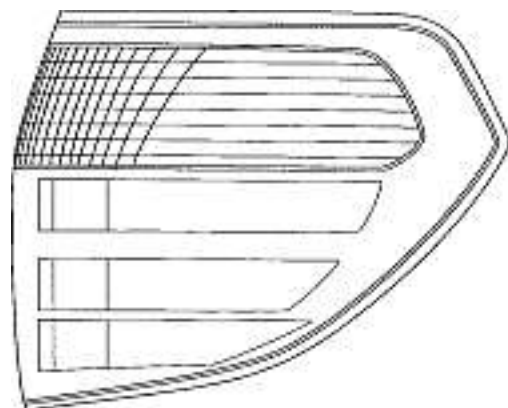
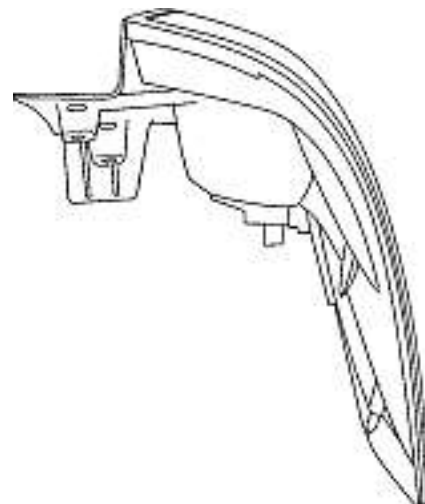
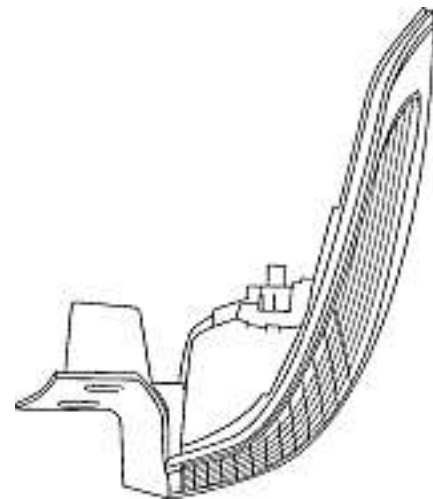
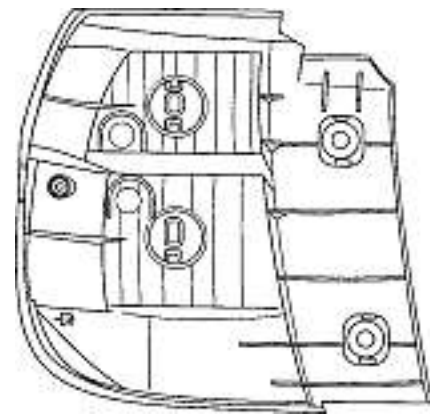
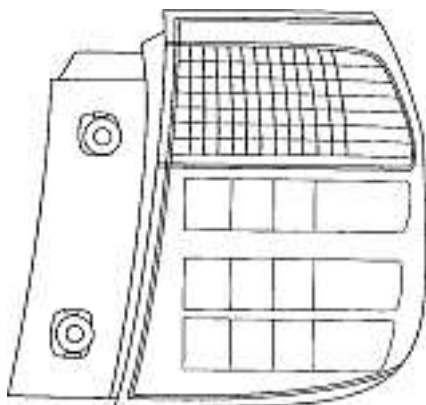

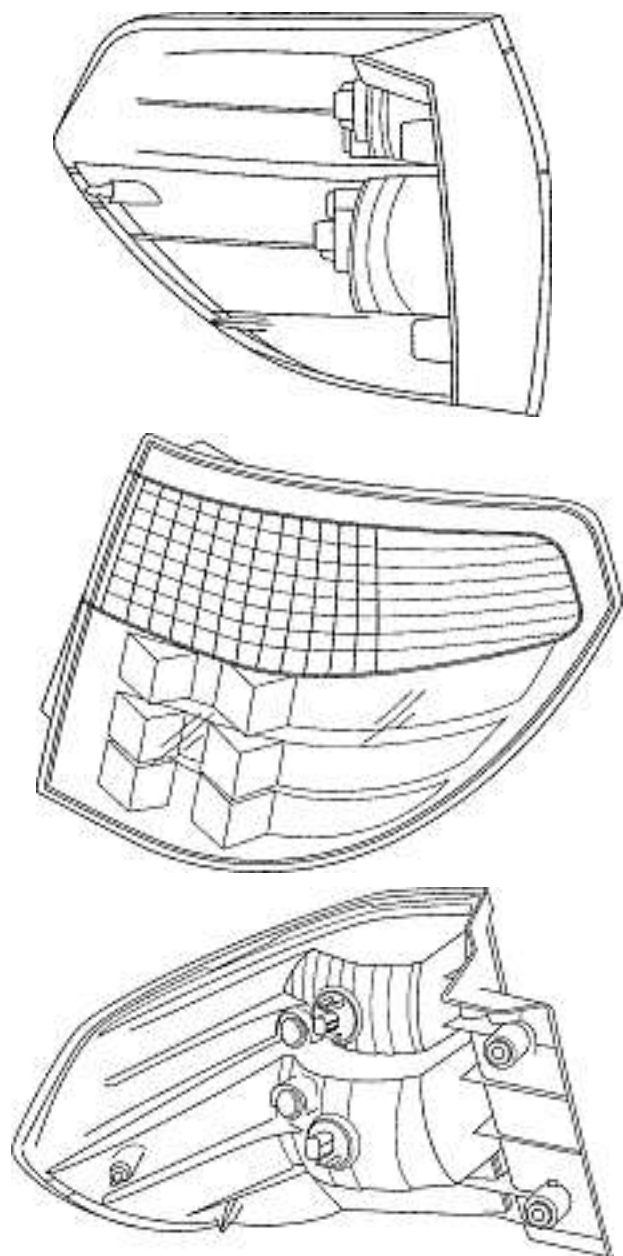

433

Cl. 26-06 130 418 15.03.2004

1 design – gruppo ottico posteriore per autovettura
 Depositante: Honda Motor Co., Ltd., No. 1-1, 2-chome,
 Minami-aoyama, Minato-ku, Tokyo, JP
 Designer: Tadahiro Kamimura, Saitama; Hajime Maniwa,
 Saitama
 Mandatario: Fiammenghi-Fiammenghi, 6900 Lugano
 Priorità: JP, 22.09.2003
 Fine del periodo di differimento della pubblicazione

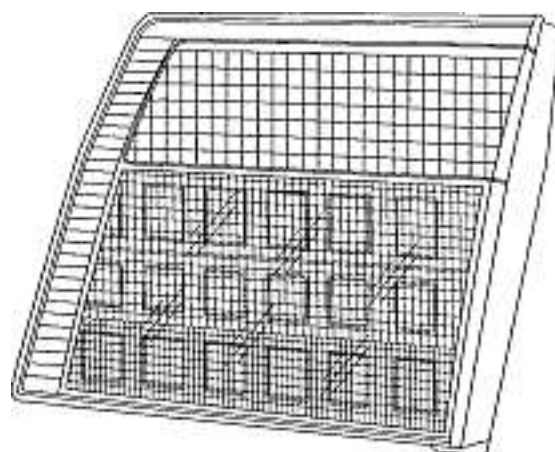
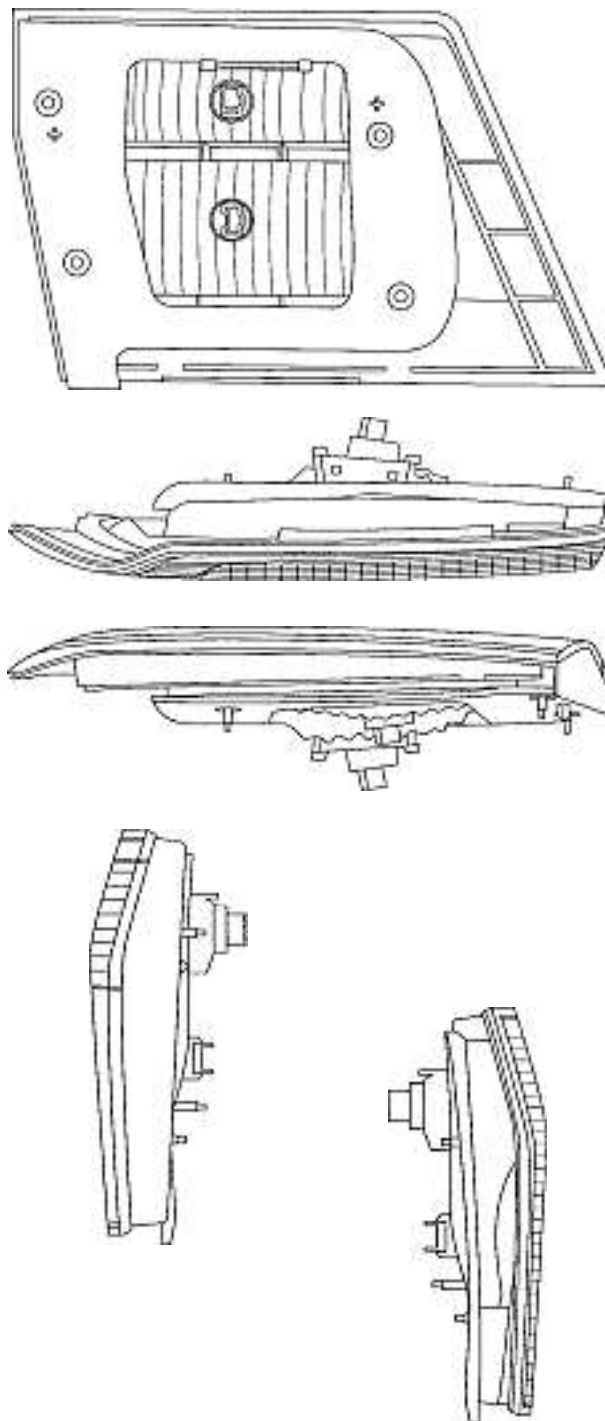
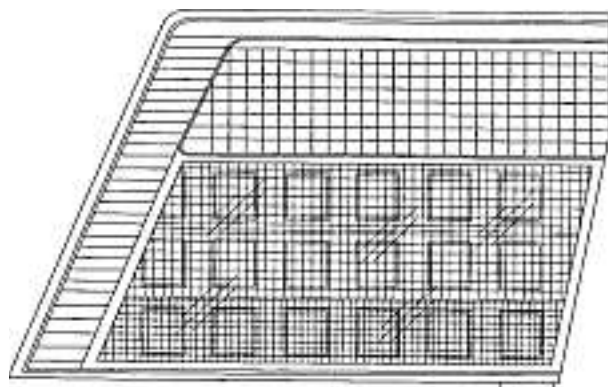

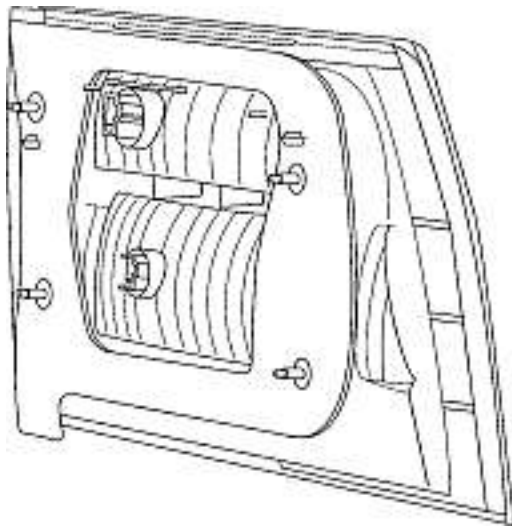

434

Cl. 23-01 132 339 22.11.2005

1 Design – Armatur

Hinterleger: Sanimatic AG, Steinhaldenstrasse 14,
8954 GeroldswilDesigner: Heinz Bögli, Fislisbach; Renato Furegati, Dietikon
Vertreter: Patentanwälte, Schaad, Balass, Menzl & Partner AG,
8034 Zürich

Ende aufgeschobene Publikation

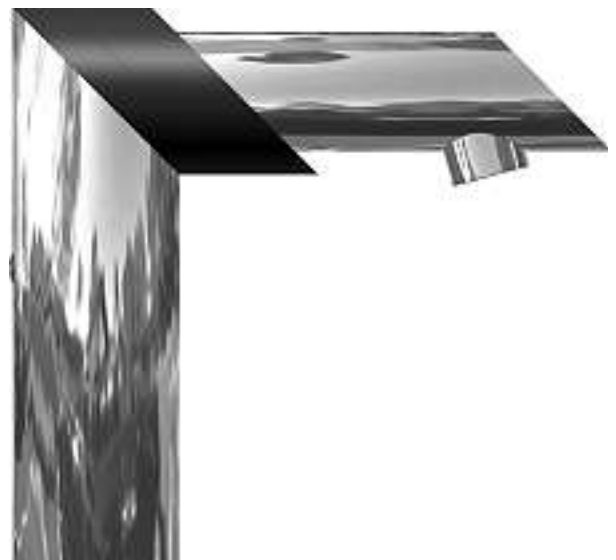



1

Cl. 01-04 **132 684** 08.03.2006
 1 Design – Fleischware
 Hinterleger: Hatecke Ludwig, Center Augustin, 7550 Scuol
 Vertreter: Diehl & Partner AG, 7513 Silvaplana



1

Cl. 03-03 **132 685** 19.03.2006
 1 design – parasol pour table
 Déposant: Gérard Wick, rue de l'Envol 34, 1950 Sion

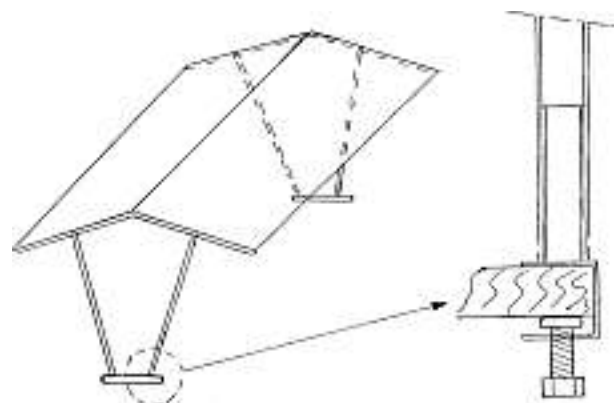

1

Cl. 04-02 **132 686** 06.04.2006
 12 Design – Zahnbürste
 Hinterleger: KerrHawe SA, Via Strecce, 6934 Bioggio
 Designer: Rosario Cipoletta, Luno; Paolo Croce, Cugnasco;
 Firmino Scodro, Arcisate
 Vertreter: E. Blum & Co., 8044 Zürich

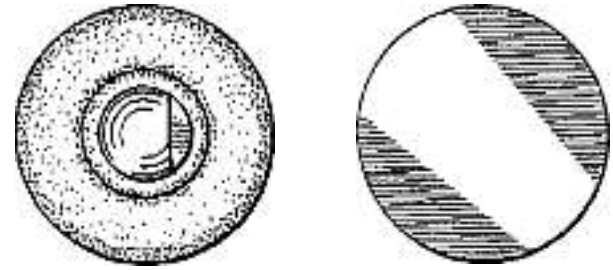
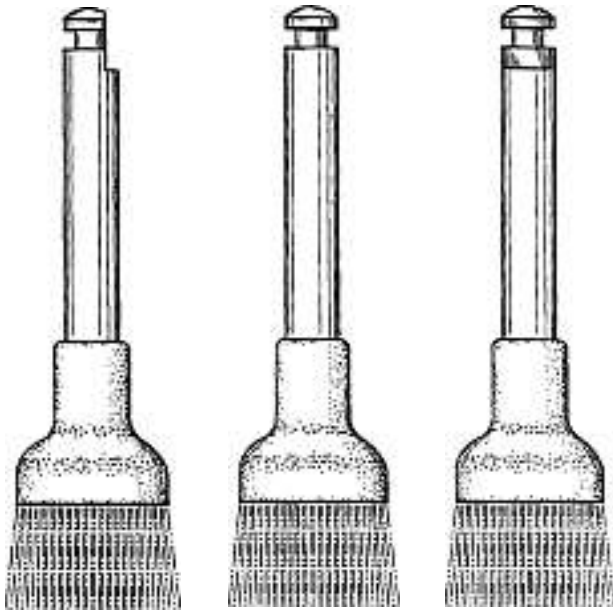

1

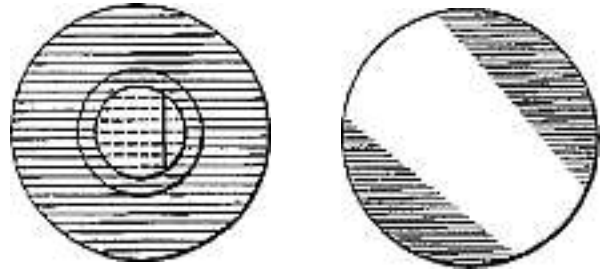
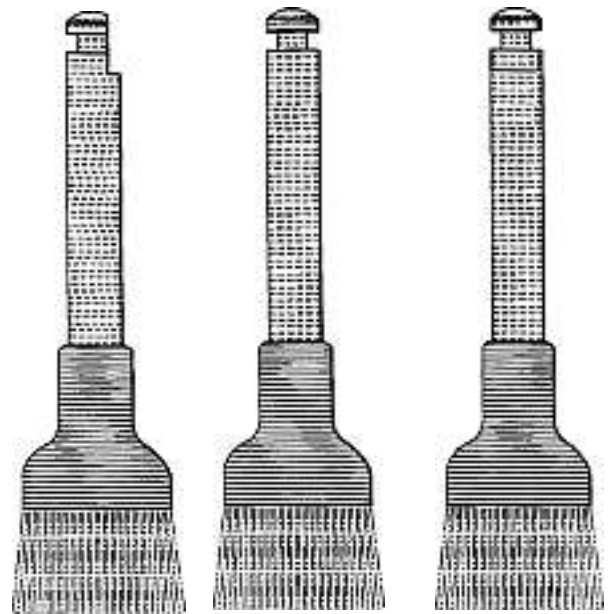

3

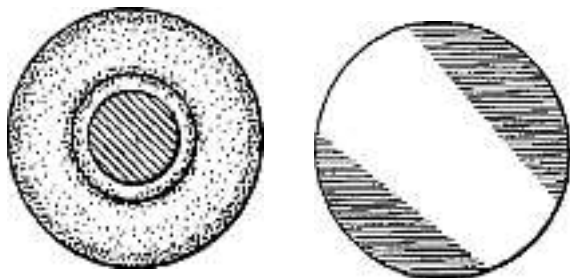
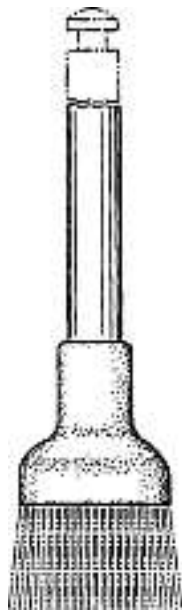

2

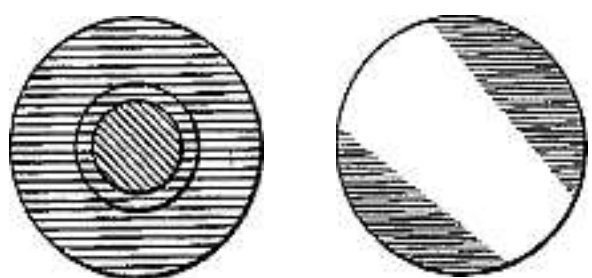
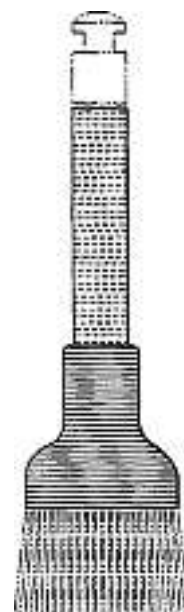

4

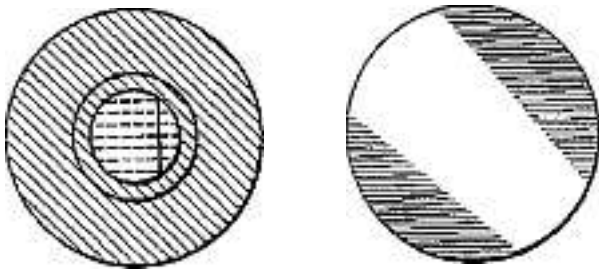
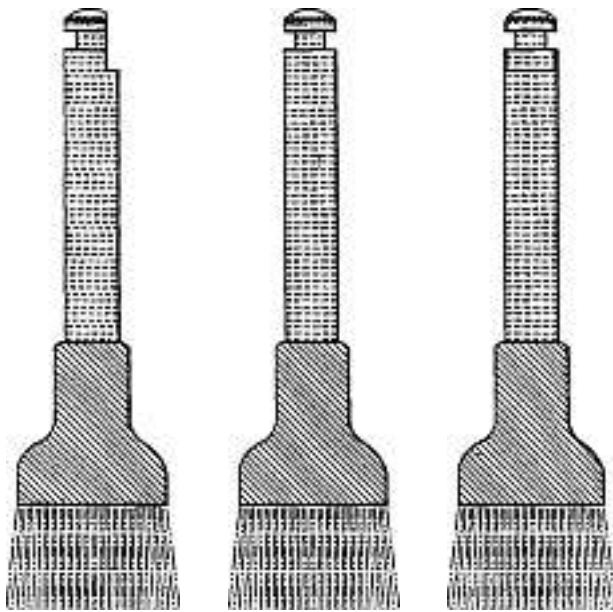

5

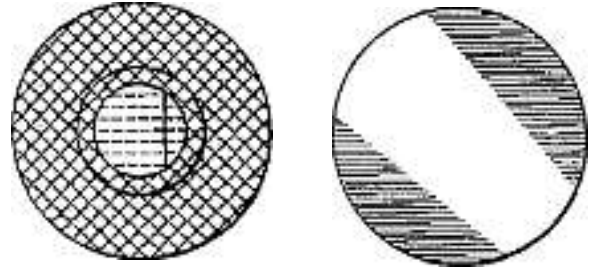
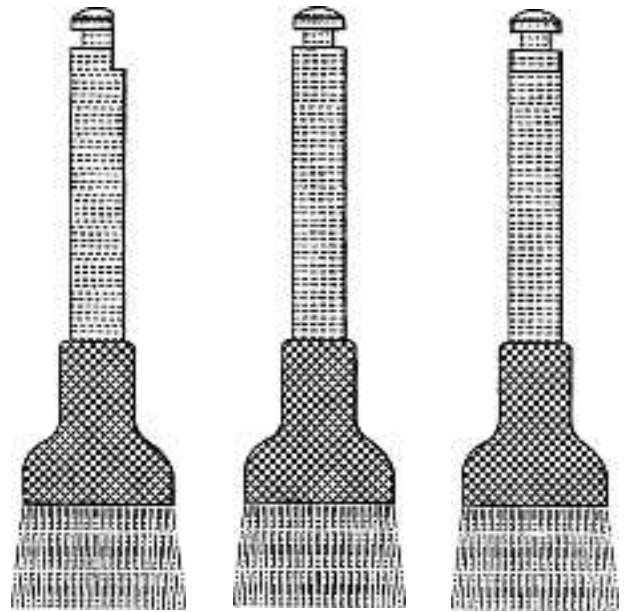

7

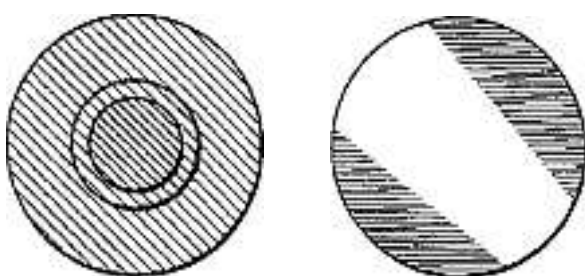
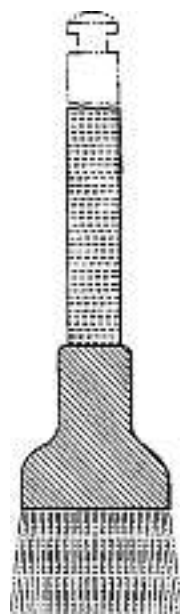

6

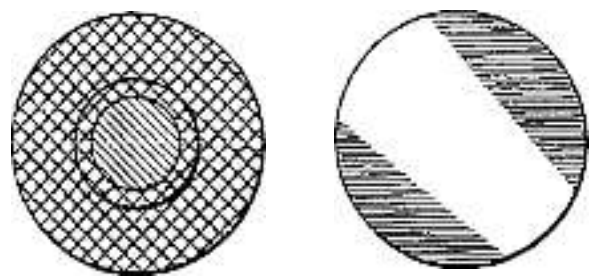

8

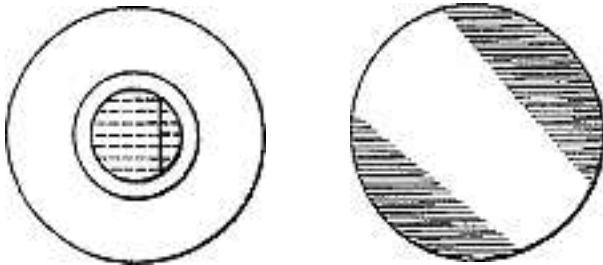
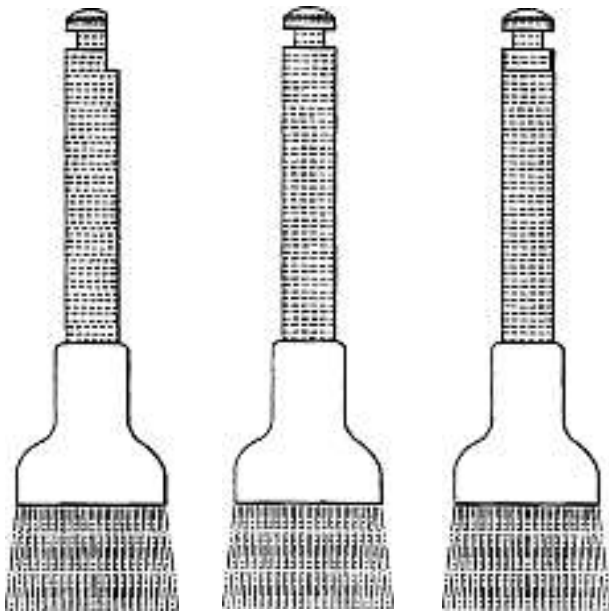

9

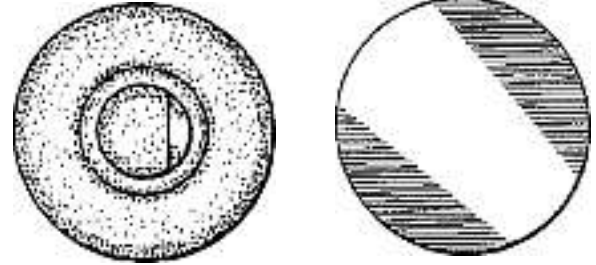
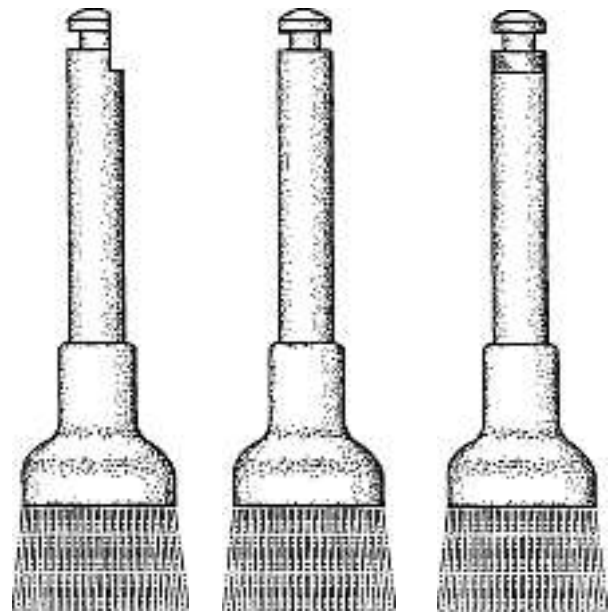

11

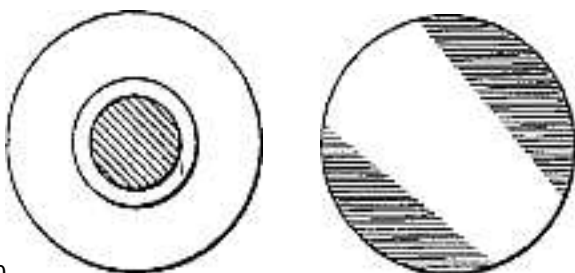
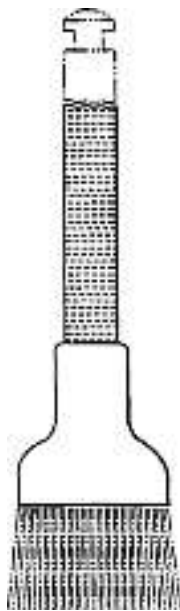

10

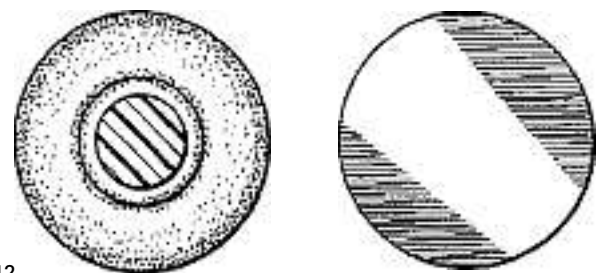
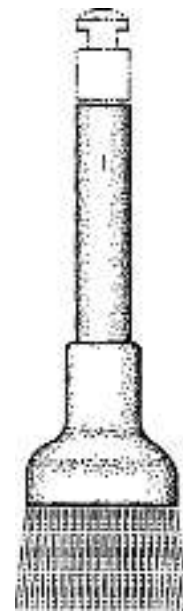

12

Cl. 06-01, 06-03 132 687 13.03.2006
 2 Design – Tisch, Bank
 Hinterleger: Stefan Ludwig, Kirchgasse 6, 7204 Untervaz



10 Tisch



11 Bank

Cl. 06-02 132 688 31.01.2006
 1 Design – Bett
 Hinterleger: Nicola Enrico Stäubli, Junkerngasse 35, 3011 Bern

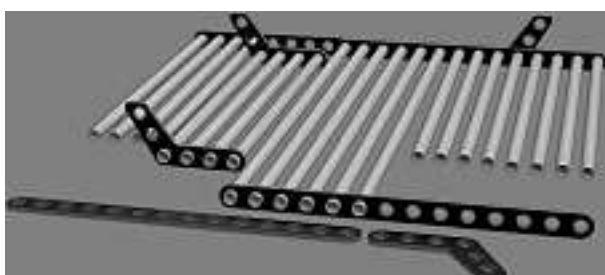

1

Cl. 07-01 132 689 09.03.2006
 5 Design – Trinkgläser
 Hinterleger: PI-DESIGN AG, Kantonsstrasse 100, 6234 Triengen
 Designer: Jorgen Bodum, St. Niklausen
 Vertreter: Isler & Pedrazzini AG, 8023 Zürich
 Priorität: DK, 14.09.2005

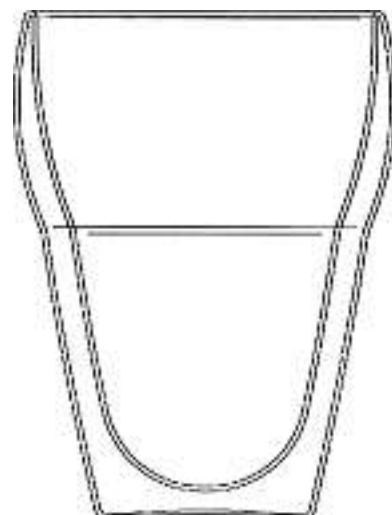

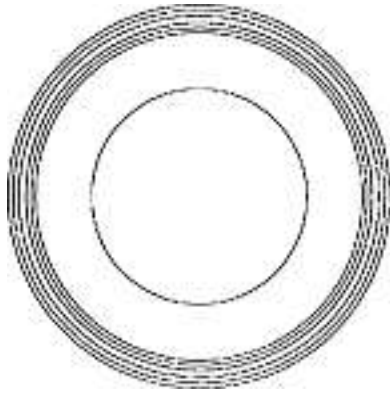
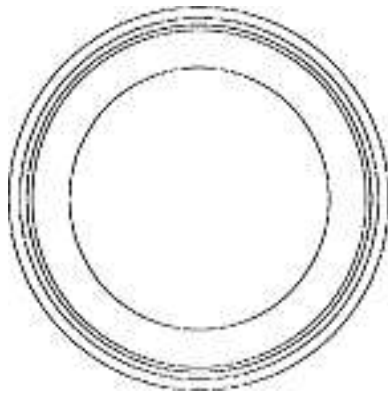

1

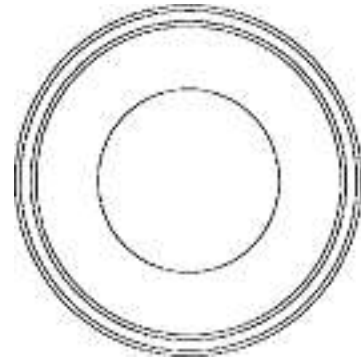
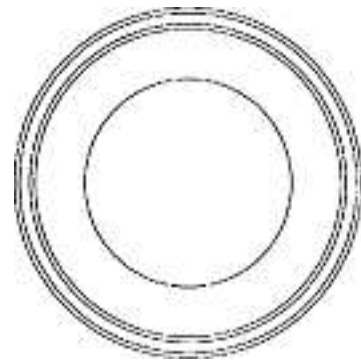
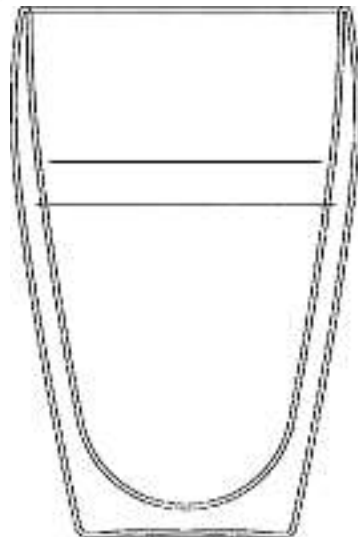

2

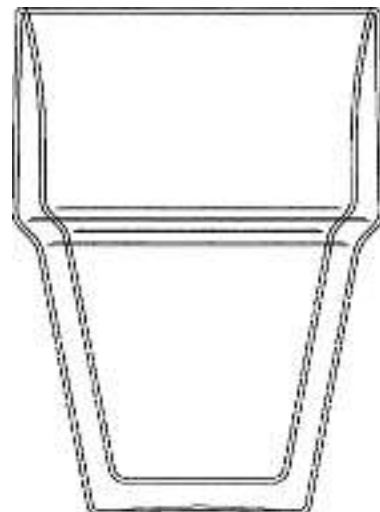
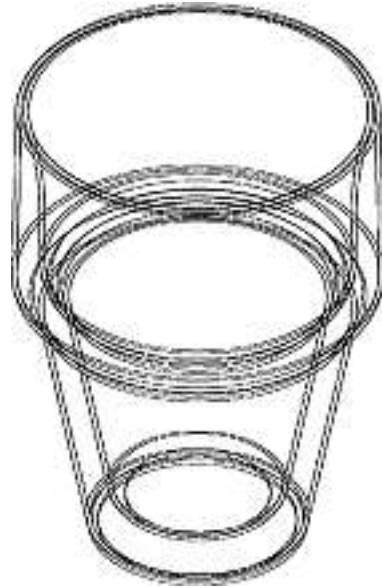

3



4

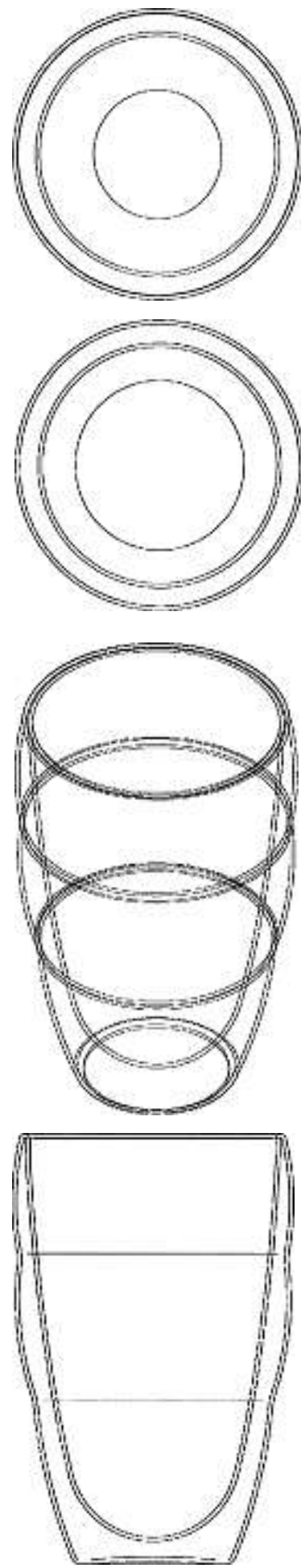

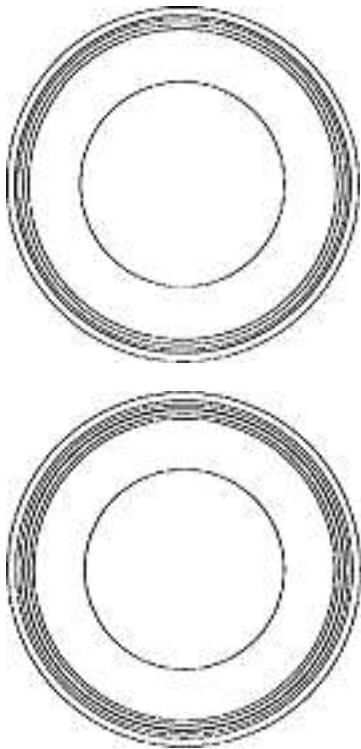

5

Cl. 07-02 **132 690** 09.03.2006
 1 design – support pour machine à café
 Déposant: Société des Produits Nestlé SA, 1800 Vevey
 Designer: Antoine Cahen, Lausanne
 Mandataire: Nestec S.A., 1800 Vevey

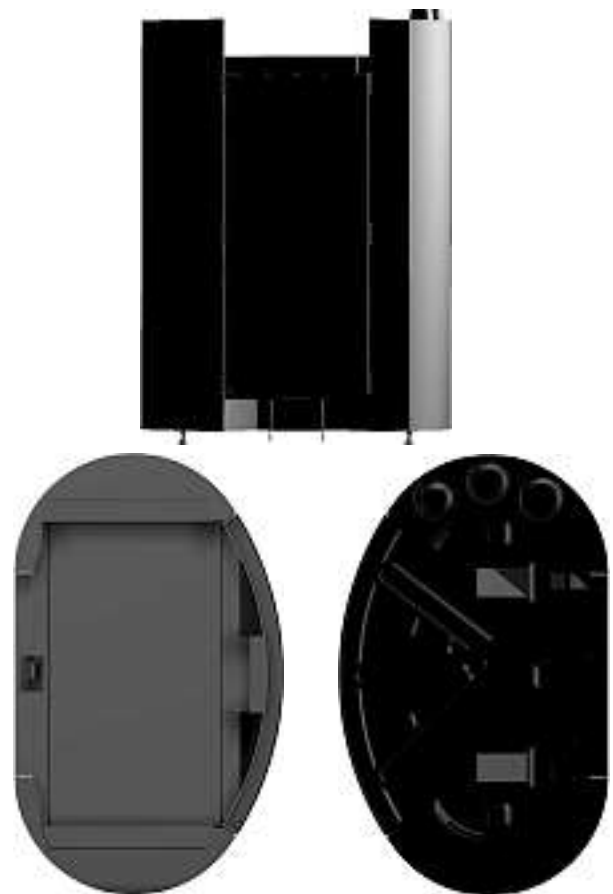
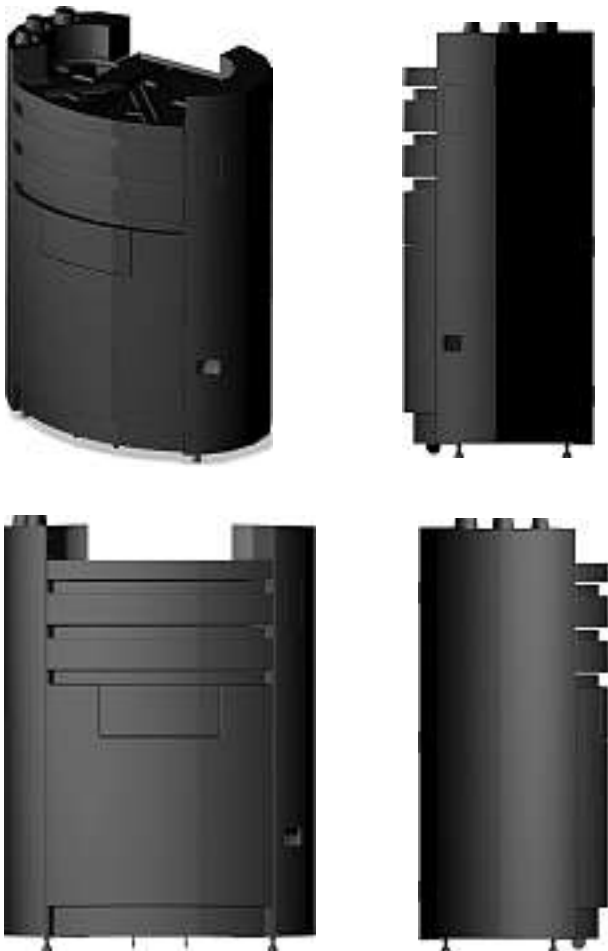

FL 60688

Cl. 07-02 **132 691** 09.03.2006
 1 design – distributeur de capsules pour machine à café
 Déposant: Société des Produits Nestlé SA, 1800 Vevey
 Designer: Antoine Cahen, Lausanne
 Mandataire: Nestec S.A., 1800 Vevey



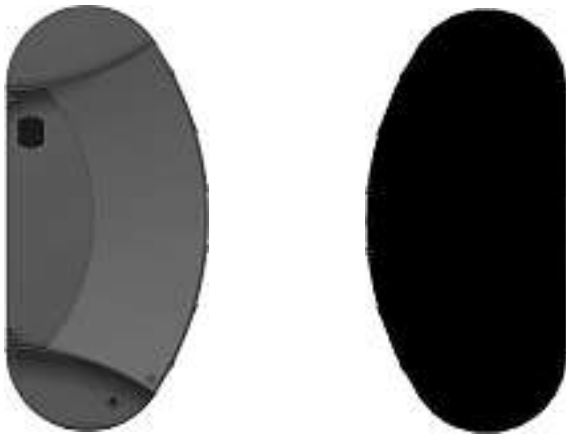
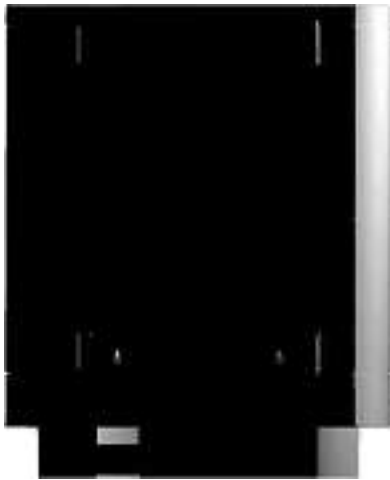

FL 60689

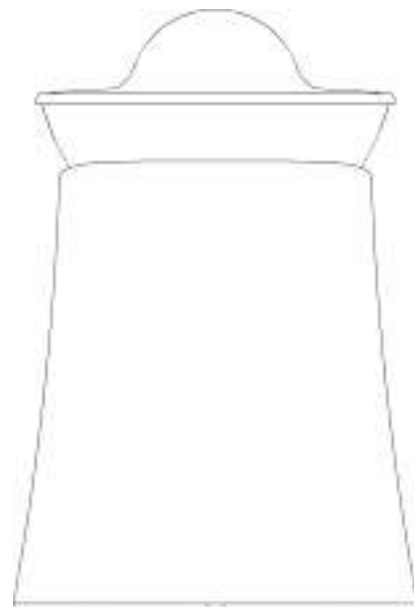

Cl. 07-04 **132 692** 21.03.2006
1 Design – Saftpresse
Hinterleger: PI-DESIGN AG, Kantonsstrasse 100,
6234 Triengen
Designer: Jorgen Bodum, St. Niklausen
Vertreter: Isler & Pedrazzini AG, 8023 Zürich
Priorität: DK, 18.10.2005

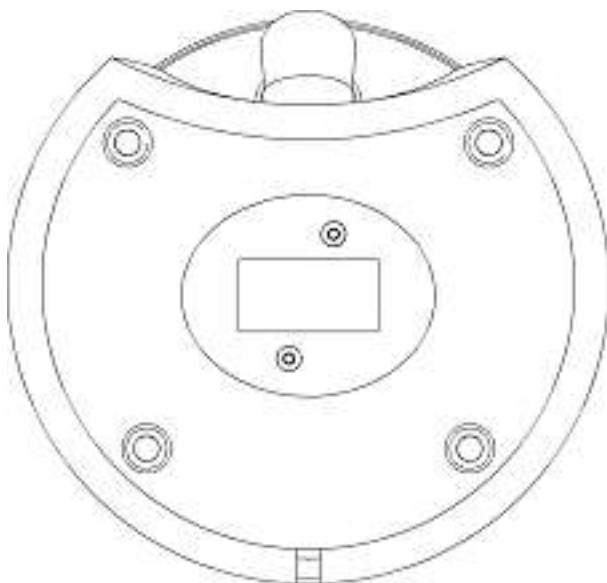
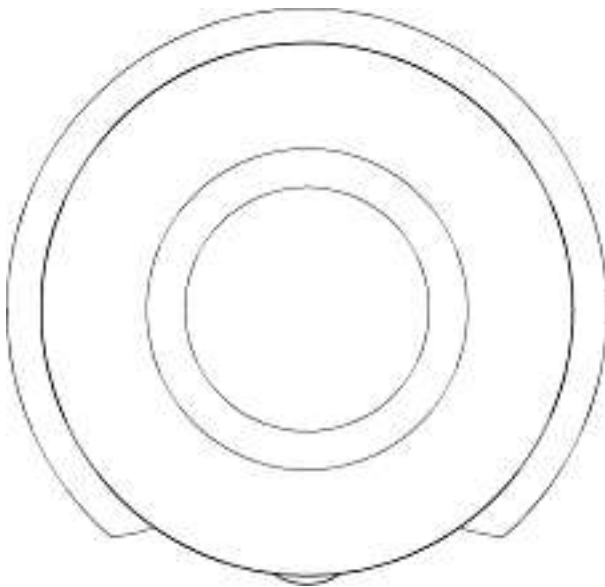

M13140

Cl. 07-99 132 693 23.03.2006

1 design – plateau (ménage)
 Déposant: Artek W - Design Sàrl,
 Boulevard du Pont-d'Arve 19, 1211 Genève 4
 Designer: Philippe Comtesse, St-George
 Mandataire: Lemman Consulting S.A., 1260 Nyon

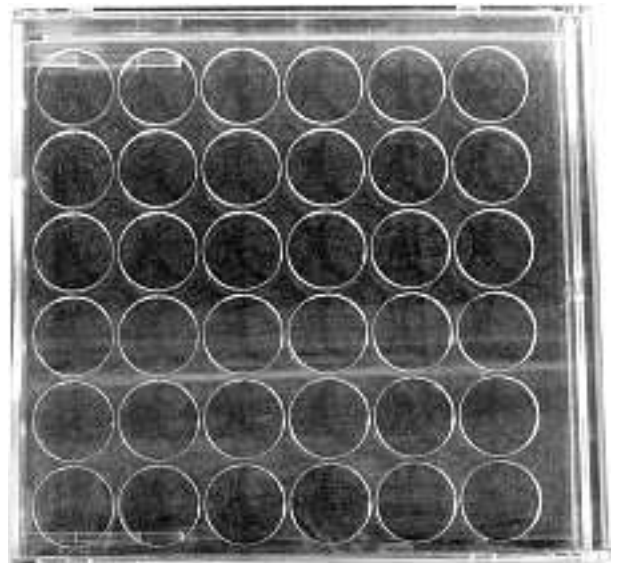

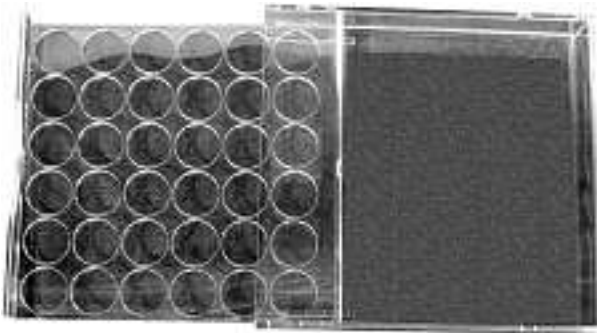

Plateau

Cl. 09-01 132 694 02.05.2006
 1 design – bouteille
 Déposant: Société des Produits Nestlé SA, 1800 Vevey
 Designer: Zhu Honghua, Shanghai
 Mandataire: Nestec S.A., 1800 Vevey

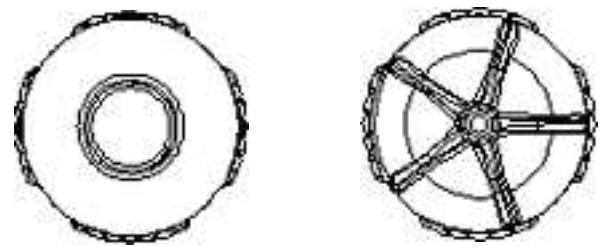
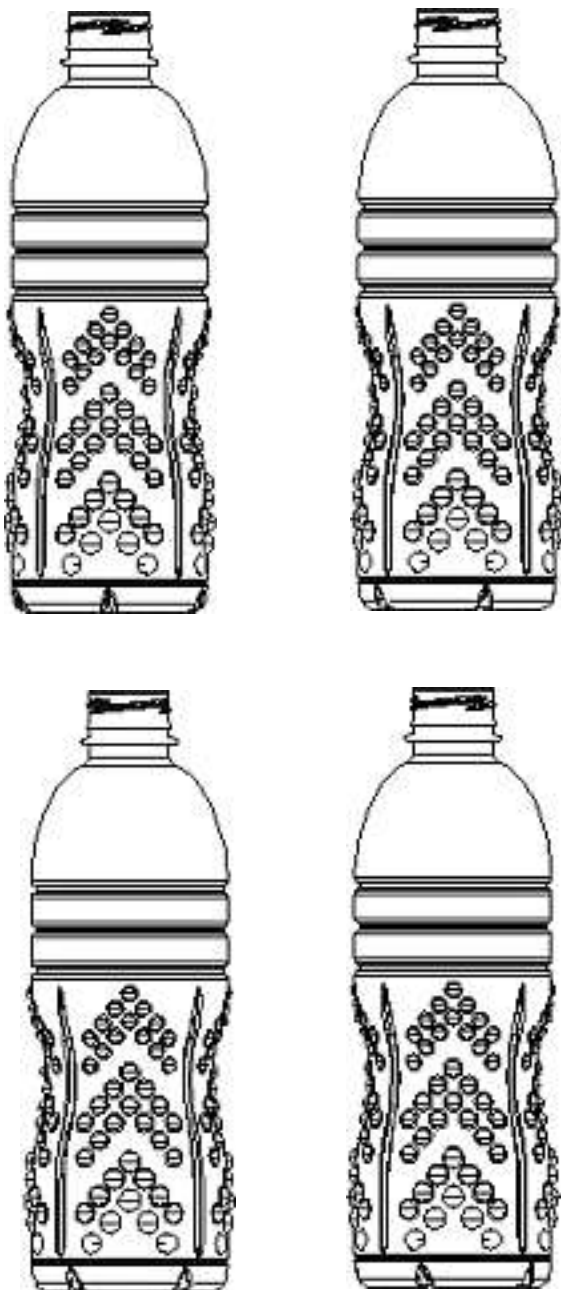

1

Cl. 09-03 132 695 08.03.2006
 1 Design – Verpackung
 Hinterleger: Hatecke Ludwig, Center Augustin, 7550 Scuol
 Vertreter: Diehl & Partner AG, 7513 Silvaplana



2

Cl. 09-03 132 696 21.03.2006
 2 Design – Verpackung, Verpackungsbemusterung
 Hinterleger: TBG Technisches Büro Geissberger GmbH,
 Feerstrasse 4, 5200 Brugg AG
 Designer: Urs Geissberger, Brugg



K2781-1007-04-000



K2781-1007-04-001

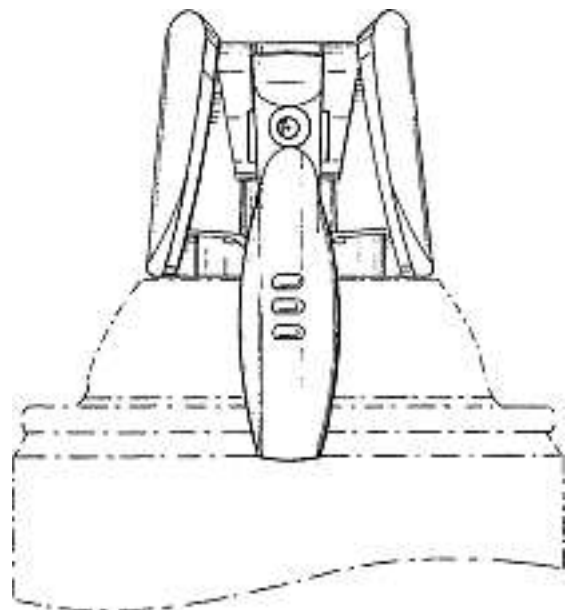
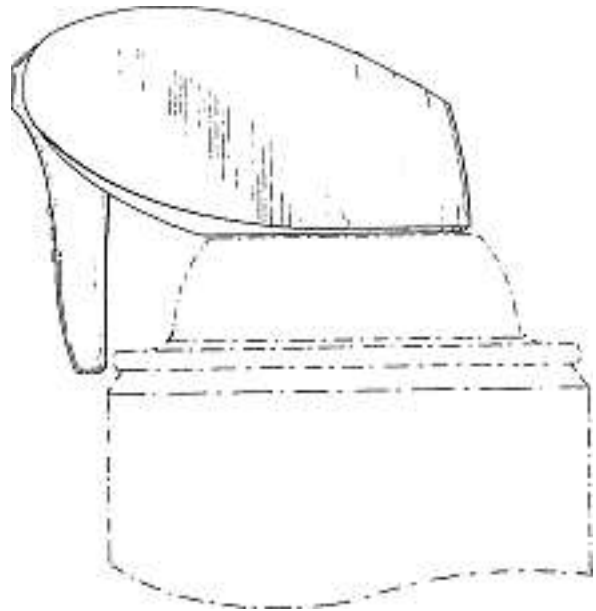

Cl. 09-07 **132 697** 21.03.2006
 1 Design – Sprühventil
 Hinterleger: WD-40 Company, 1061 Cudahy Place,
 San Diego (CA 92110), US
 Designer: Gad Shaanan, La Jolla; Douglas John Todd,
 San Diego; Francois Duval, Terrebonne; Ivan Brousseau,
 Montreal; Predrag Pudar, Montreal
 Vertreter: Schneider Feldmann AG, Patent- und
 Markenanwälte, 8039 Zürich
 Priorität: US, 07.10.2005

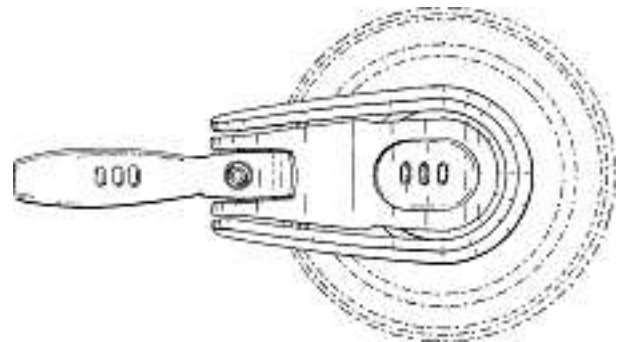
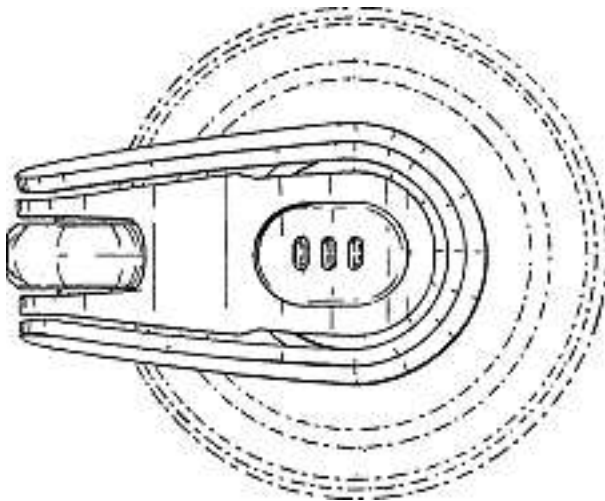
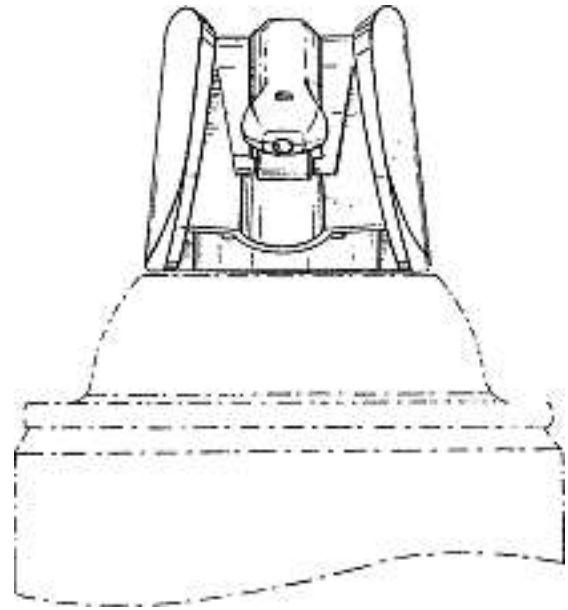
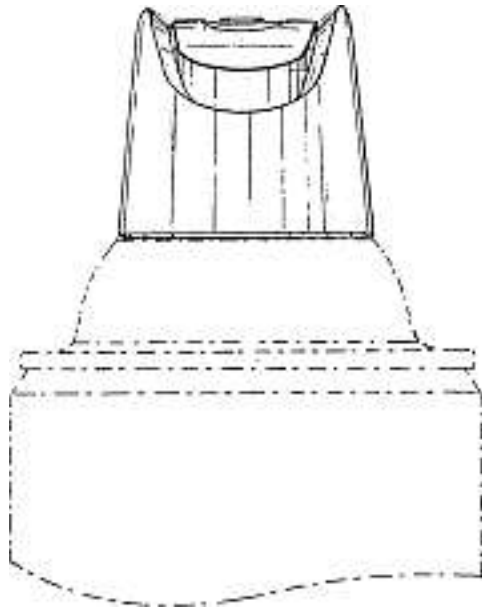

WDC-001-D-CH

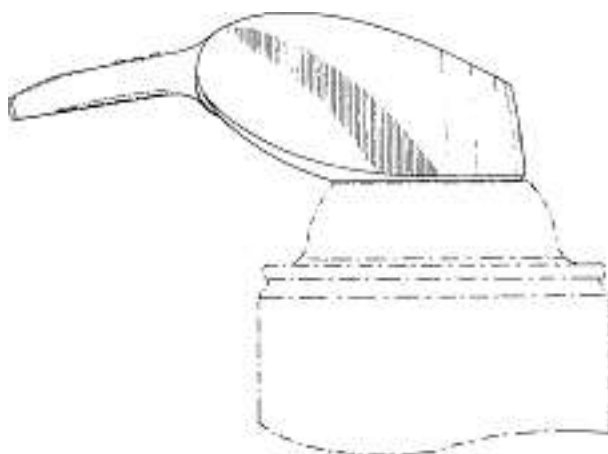
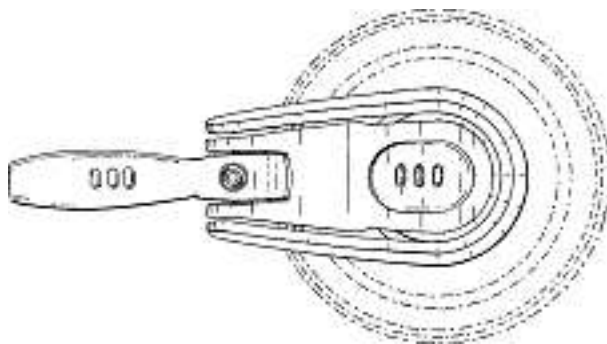

Cl. 10-02 132 698 17.03.2006

1 design – montre-bracelet
Déposant: Desco von Schulthess AG, Brandschenkestrasse 2,
8002 Zürich
Designer: Sandro Reginelli, Neuchâtel
Mandataire: Inteltech SA, 2001 Neuchâtel





Cl. 10-02, 10-07 132 699 18.03.2006
 3 Design - Lunette, Uhren
 Hinterleger: Urs Ryser Swiss Timepieces,
 929 Sir Francis Drake BLVD # 204, Kentfield / CA, US
 Designer: Urs Ryser, Kentfield
 Vertreter: Rosmarie Ryser, 2515 Prêles



RK1



RK2



RK3

Cl. 10-02, 10-07 132 700 22.03.2006
 2 design – montre-bracelet, protège-couronne
 Déposant: Ball Watch Company SA, Rue J.-L. Pourtalès 10,
 2000 Neuchâtel
 Designer: Henry Duong, Hong Kong
 Mandataire: Inteltech SA, 2001 Neuchâtel



1

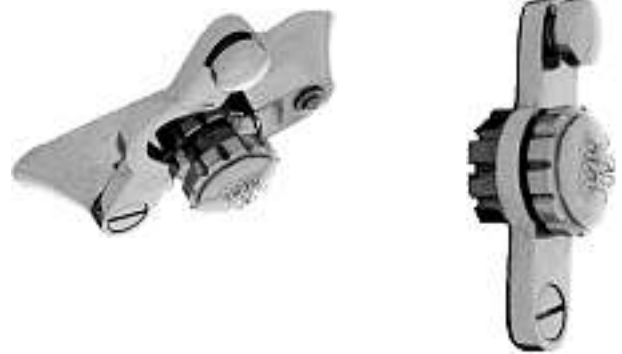

2

Cl. 10-04, 10-06, 10-07 132 703 09.03.2006
 4 design – cadran de montre, cadrans d'instrument de
 mesure et de signalisation
 Déposant: Les Ateliers Louis Moinet S.A.,
 Rue des Epancheurs 24, 1202 Auvier
 Designer: Jean-Marie Schaller, Auvier
 Mandataire: Inteltech SA, 2001 Neuchâtel



1



2



3



4

Cl. 10-07 132 704 14.03.2006
 5 design – lunettes de montre, carrure de montre et boîte de
 montre
 Déposant: Montres Tudor S.A., 3, rue François Dussaud,
 1211 Genève 26
 Designer: Daniel Riedo, Genève
 Mandataire: Bugnion S.A., 1211 Genève 12 - Champel



1

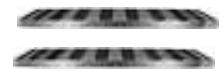

2



3



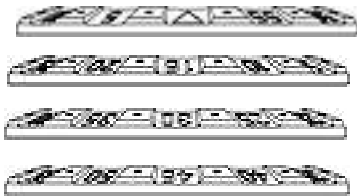

4

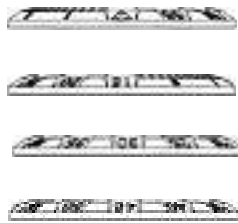

5

Cl. 11-01 132 706 22.03.2006
1 Design – Schmuckstück
Hinterleger: Jean Claude Bannier, Lindenstrasse 22,
4102 Binningen



Helvetia Pin Schweiz

Cl. 11-02 132 708 17.03.2006
1 Design – Mobile
Hinterleger: Bruno Kissling, Weststrasse 25, 3006 Bern

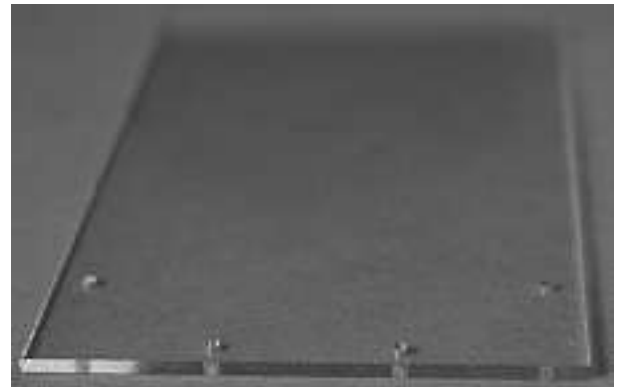
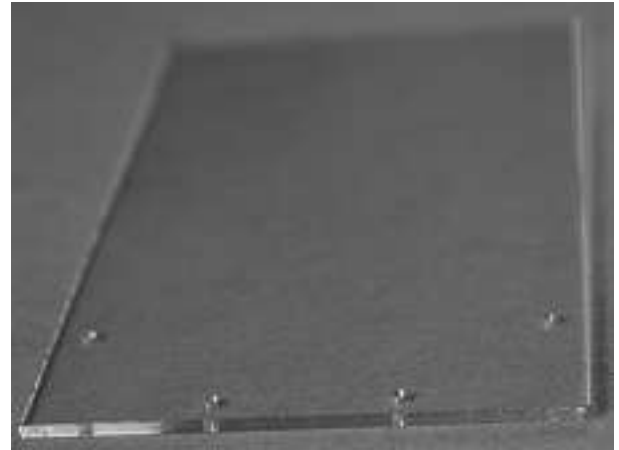
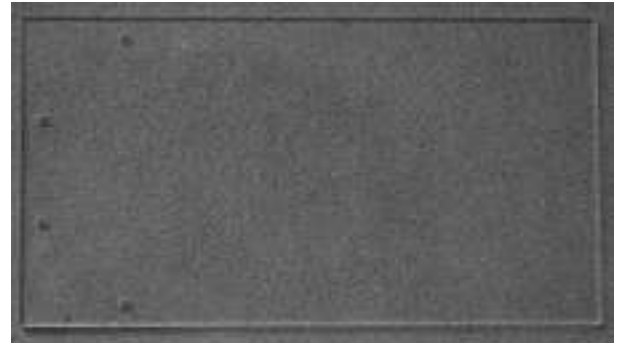

001.00

Cl. 12-15 132 709 14.03.2006
2 design – pneumatici
Depositante: Pirelli Pneumatici S.p.A., Viale Sarca 222,
20126 Milano, IT
Designer: Gunter Steinbach, Milano; Christian Casper, Milano
Mandatario: Fiammenghi-Fiammenghi, 6900 Lugano
Priorità: EM, 16.09.2005; EM, 16.09.2005



471/1

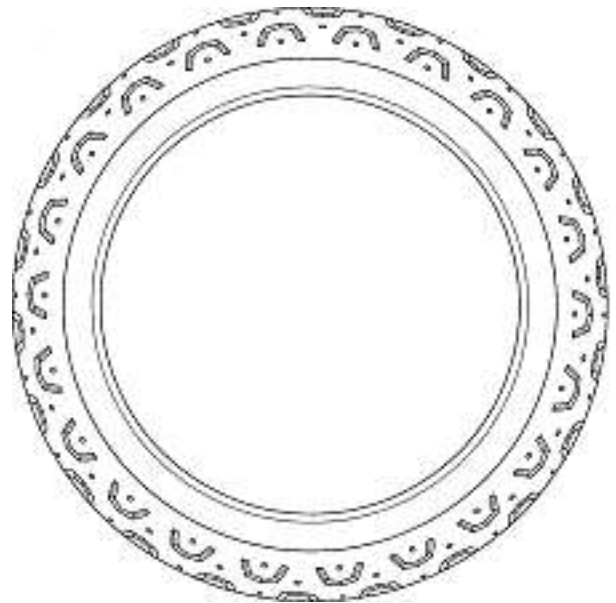
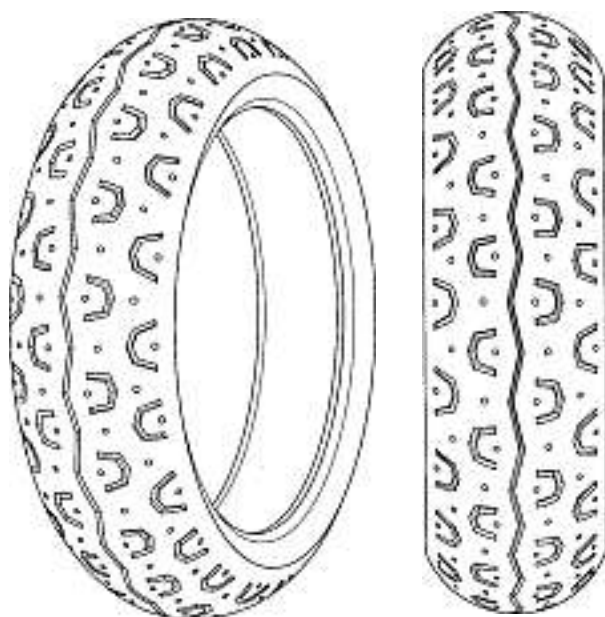

471/2

Cl. 12-15 **132 710** 14.03.2006
 2 design – pneumatici
 Depositante: Pirelli Pneumatici S.p.A., Viale Sarca 222,
 20126 Milano, IT
 Designer: Sergio Pannain, Milano
 Mandatario: Fiammenghi-Fiammenghi, 6900 Lugano
 Priorità: EM, 29.09.2005; EM, 29.09.2005

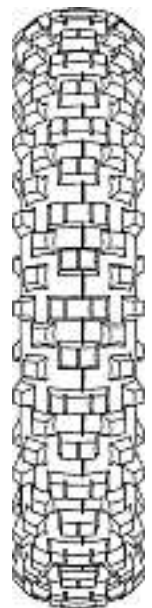
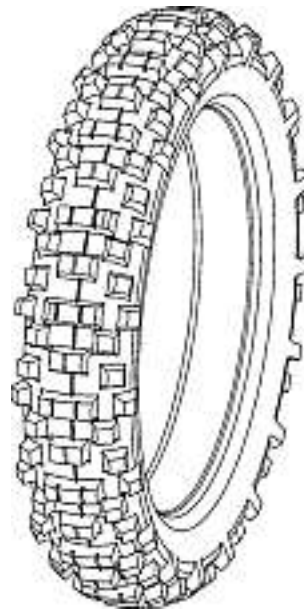

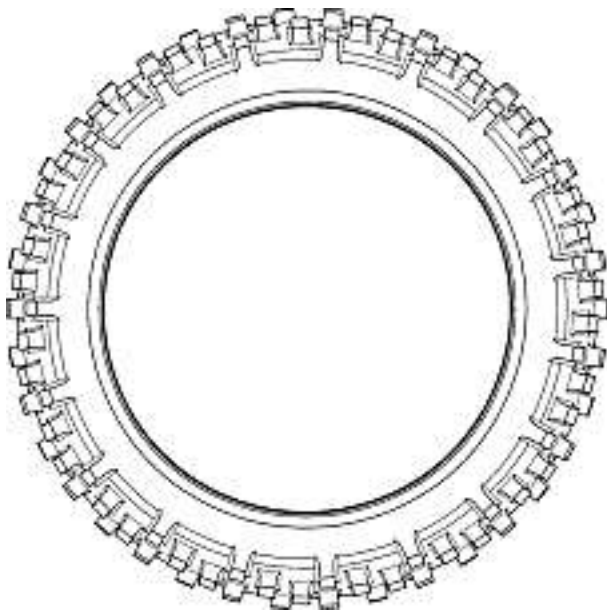

469/1

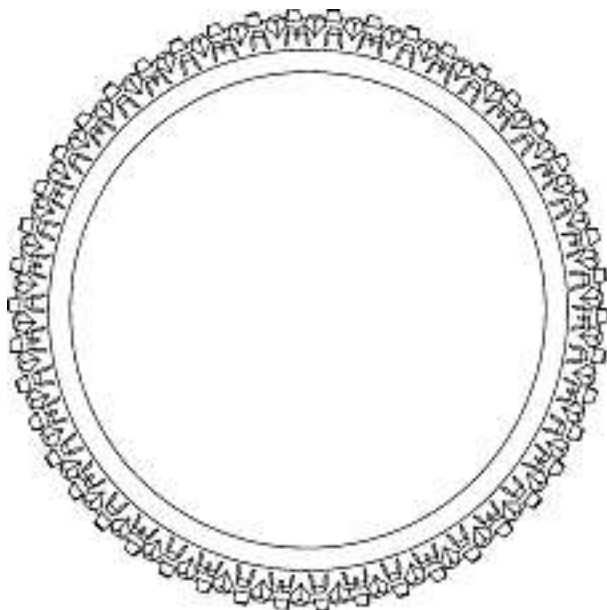

469/2

Cl. 12-16 132 711 08.03.2006
1 Design – Felge
Hinterleger: BBS Kraftfahrzeugtechnik AG, Welschdorf 220,
Schiltach, DE
Designer: Klaus Baumgartner, Schenkenzell
Vertreter: R. A. Egli & Co., Patentanwälte, 8008 Zürich
Priorität: EM, 26.01.2006





1

Cl. 12-16 132 712 14.03.2006
 1 Design – Fahrzeugfelge
 Hinterleger: Edmund Breyton, Breitere 18, Stockach, DE
 Vertreter: Hiebsch & Peege AG, Patentanwälte,
 8201 Schaffhausen



1

Cl. 14-01 132 713 23.03.2006
 1 Design – Steuerungs-/Kontrollanordnung
 Hinterleger: Shure Acquisition Holdings, Inc.,
 5800 West Touhy Avenue, Niles/IL, US
 Designer: Matthew Engstrom, Evanston; Scott Belliveau,
 Plainfield; Daniel Perez, Chicago; Ki Bok Song, Des Plaines;
 Tianzhu Wang, Chicago
 Vertreter: E. Blum & Co., 8044 Zürich
 Priorität: US, 30.11.2005

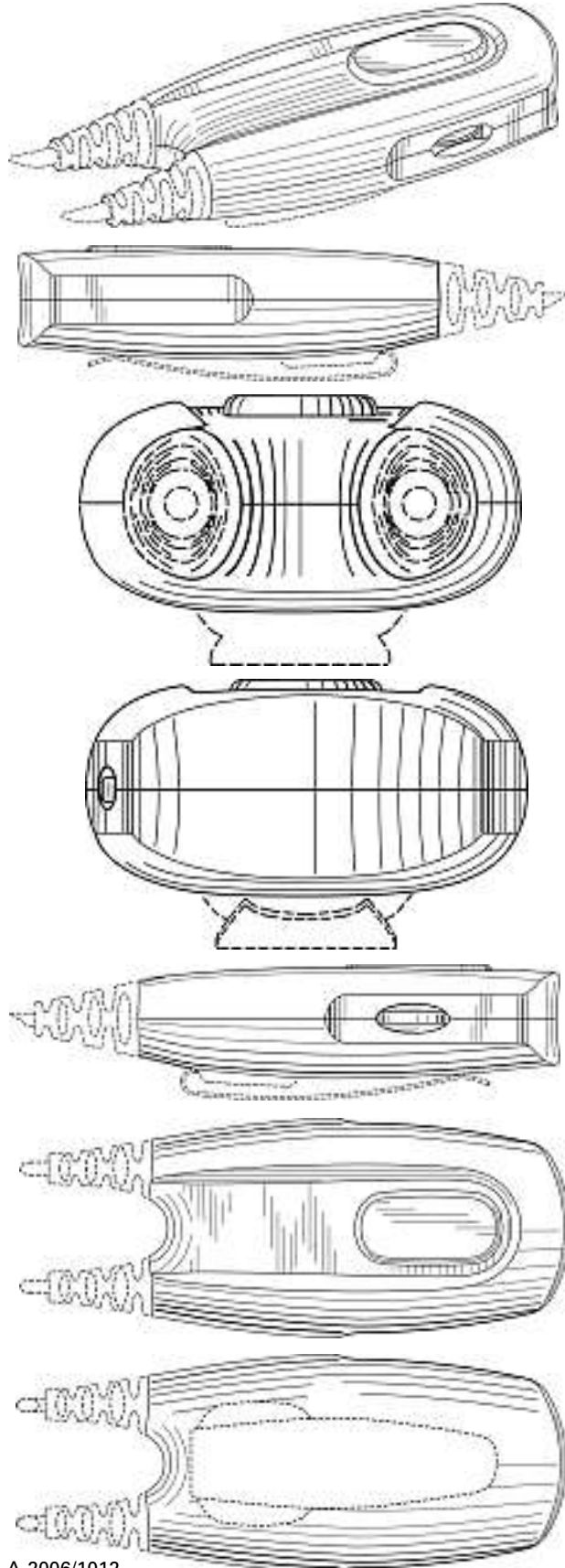

A-2006/1012

Cl. 14-03 132 714 10.03.2006
 1 Design – Radio
 Hinterleger: ETON Corporation, 1015 Corporation Way,
 Palo Alto / CA, US
 Designer: Jörg Tragatschnig, Zell am See
 Vertreter: A.W. Metz & Co. AG, 8024 Zürich
 Priorität: US, 03.01.2006

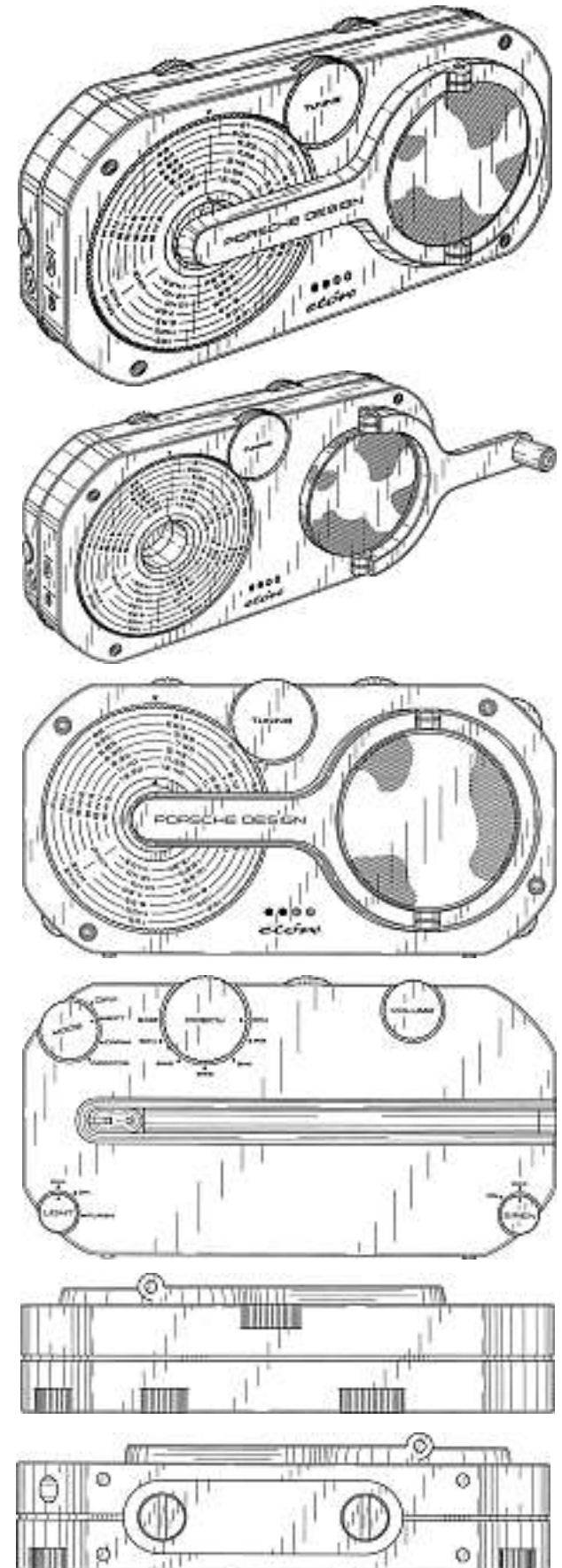

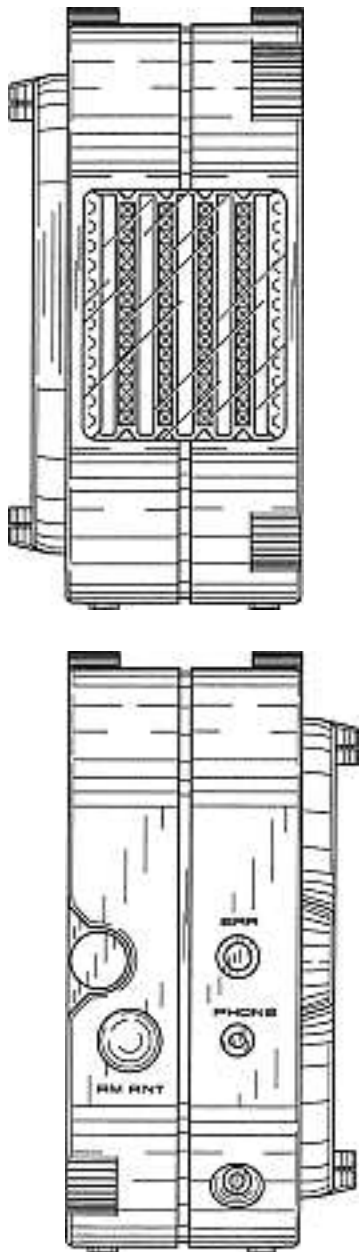

52914-CH-1-DA

Cl. 18-01 **132 715** 20.03.2006
 1 Design – Taschenrechner
 Hinterleger: MACMA Werbeartikel oHG,
 Thomas-Mann-Strasse 60, Nürnberg, DE
 Designer: Matthias Huff, Altdorf
 Vertreter: Isler & Isler, 6342 Baar



RSH109

Cl. 21-04 **132 716** 08.03.2006
 2 Design – Bar-/Festzelt
 Hinterleger: X-Top Event-Management AG, Holzweidweg 14,
 8340 Hinwil
 Designer: Wolfgang Schlumpf, Hinwil

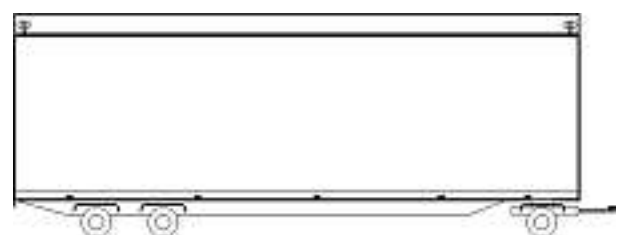

1-Barwagen

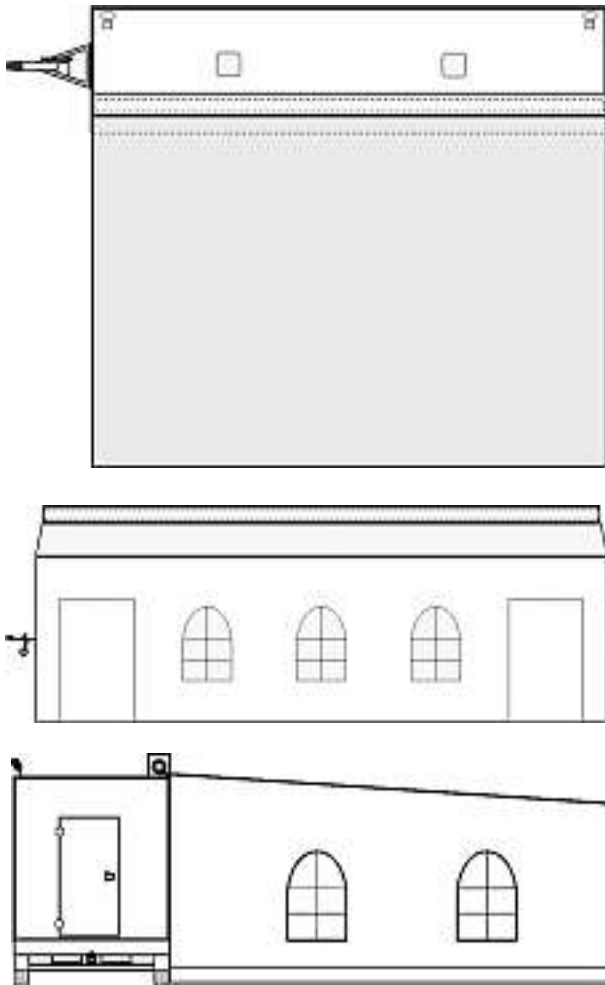

2-Zelt

Cl. 23-02 **132 717** 09.03.2006
 1 Design – Wanne
 Hinterleger: swissfloat gmbh, St. Georgenstrasse 195,
 9011 St. Gallen
 Designer: Janos Escher, Suhr; Ruedi Kamm, St. Gallen;
 Roland Gahler, St. Gallen



Wanne Typ one

Cl. 23-03 **132 718** 10.03.2006
 1 Design – Ofen
 Hinterleger: Henk Sikken, Seemattstrasse 1, 6330 Cham



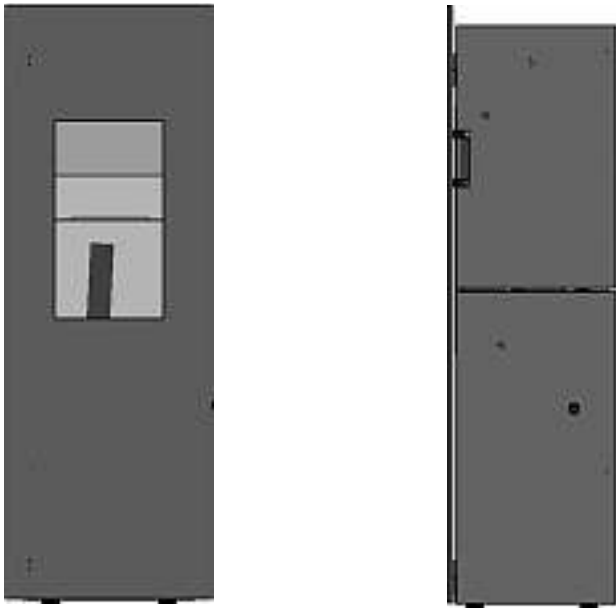

S3

Cl. 24-03 **132 719** 13.03.2006
 1 Design – Prothese
 Hinterleger: GS Development AB, Jägershillgatan 15,
 Malmö, SE
 Designer: Göran Lundborg, Genarp
 Vertreter: Staiger, Schwald & Partner, 8027 Zürich
 Priorität: EM, 13.01.2006



0051-DES-CH

Cl. 25-01 **132 720** 16.03.2006
 5 Design – Plattenbemusterung
 Hinterleger: Christian Näf, Hofstetstrasse 2, 9302 Kronbühl



Kugel



Kegel



Kubus

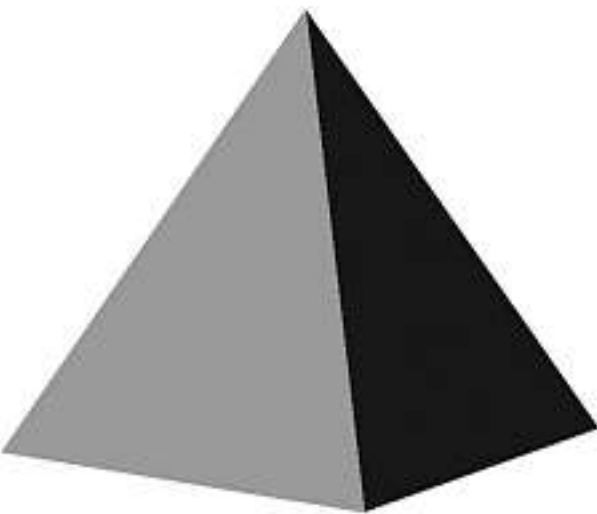

Pyramide

Cl. 26-02 132 721 20.03.2006
1 Design – Taschenlampe
Hinterleger: MACMA Werbeartikel oHG,
Thomas-Mann-Strasse 60, Nürnberg, DE
Designer: Matthias Huff, Altdorf
Vertreter: Isler & Isler, 6342 Baar

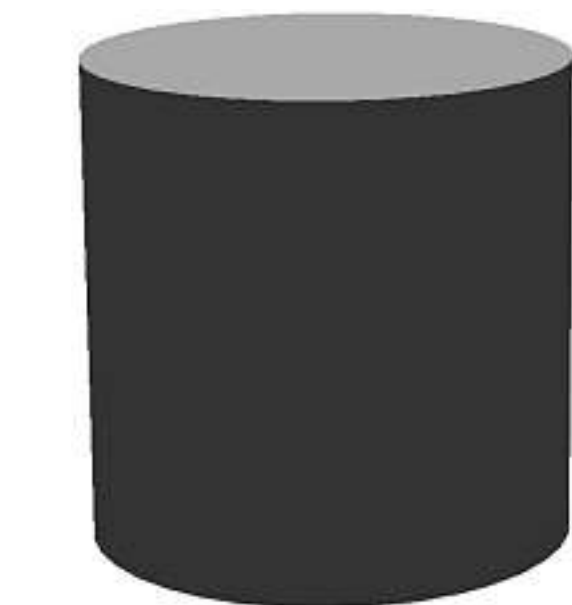

Zylinder



RSH108



Cl. 26-05 132 722 15.03.2006
1 Design – Lampe
Hinterleger: Ansorg GmbH, Solinger Strasse 19,
45481 Mülheim an der Ruhr, DE
Designer: Klaus Schwitzke, Düsseldorf
Vertreter: AXON Patent GmbH, 4147 Aesch



1

Cl. 26-05 132 723 16.03.2006
1 Design – Leuchte
Hinterleger: Zoran Spehar, Hohlstrasse 118, 8004 Zürich

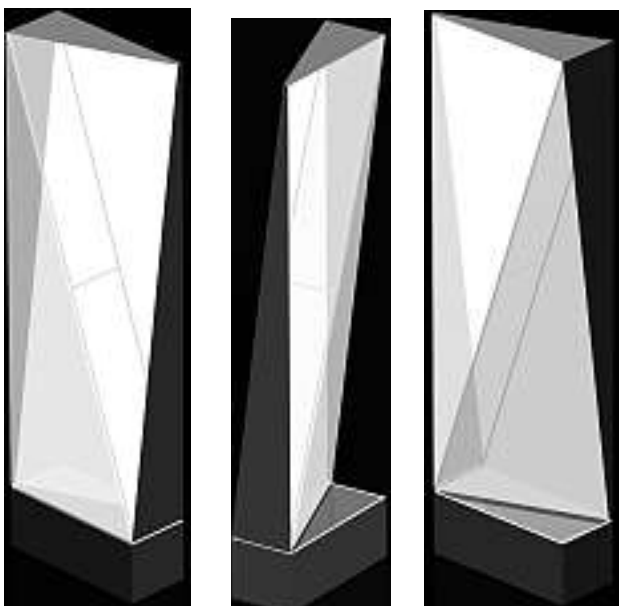

060316 Leuchte

Cl. 27-05 132 724 13.03.2006
1 Design – Feuerzeug
Hinterleger: Jens Bleich, Dornierstrasse 3, Germering, DE;
Jürgen Bleich, Dornierstrasse 3, Germering, DE
Vertreter: Ammann Patentanwälte AG Bern, 3001 Bern

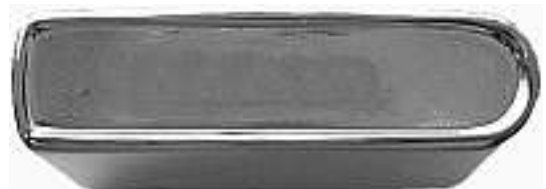



58084 CH-6

Cl. 28-03 **132 725** 09.03.2006
 2 Design – Ablagevorrichtung für Rasierer
 Hinterleger: The Gillette Company, Prudential Tower
 Building, Boston / MA, US
 Designer: Christopher Ramm, North Attleboro; Michael J.
 Gray, Duxbury
 Vertreter: A. Braun, Braun, Héritier, Eschmann AG,
 Patentanwälte, 4051 Basel
 Priorität: US, 09.09.2005

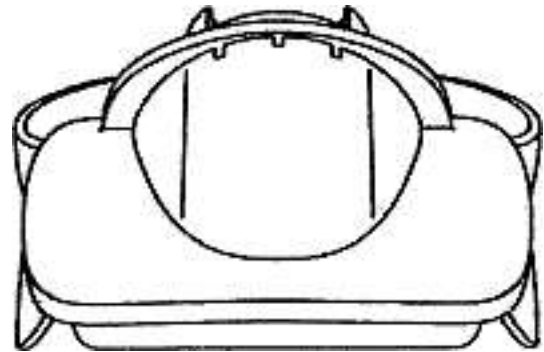
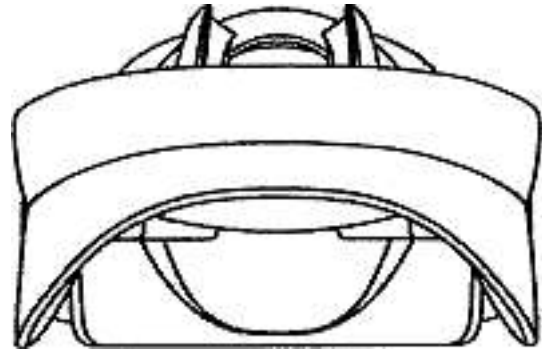
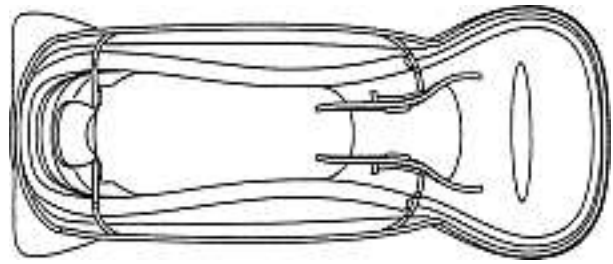

1

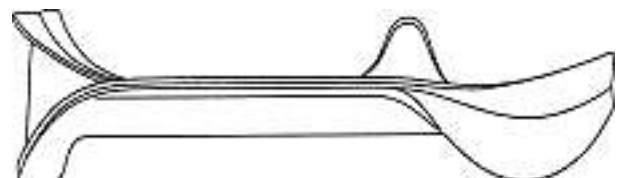
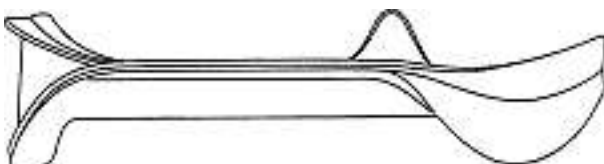
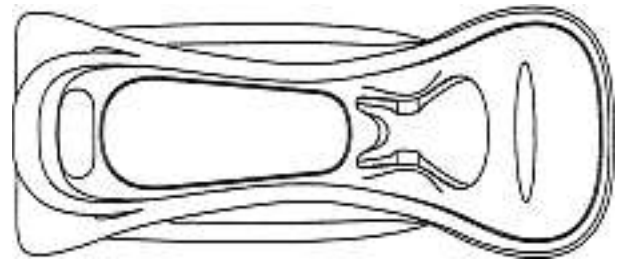
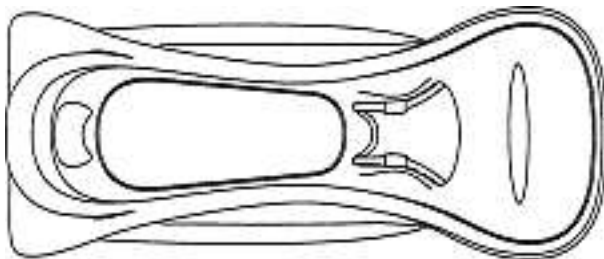
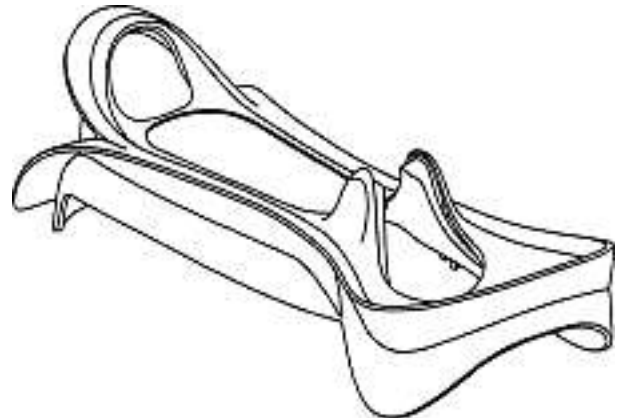
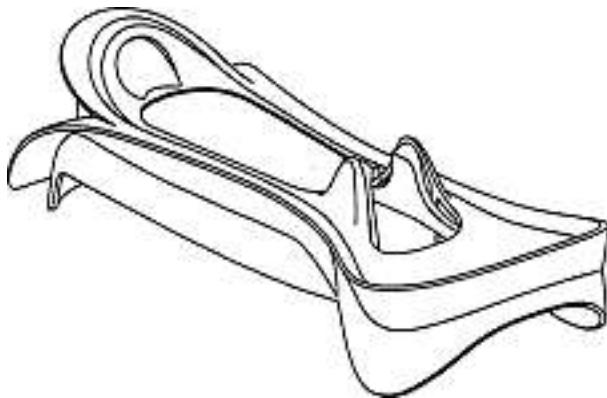

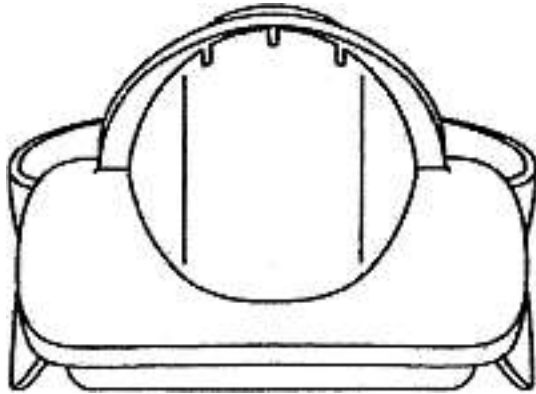
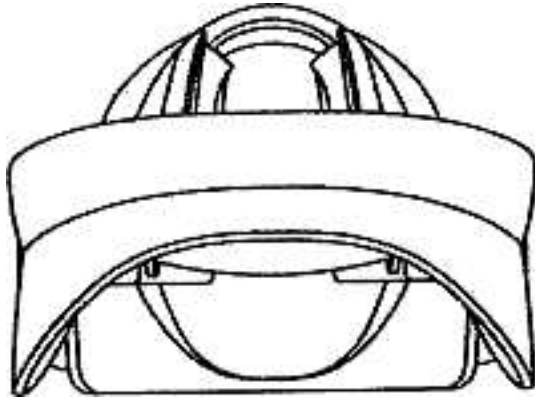
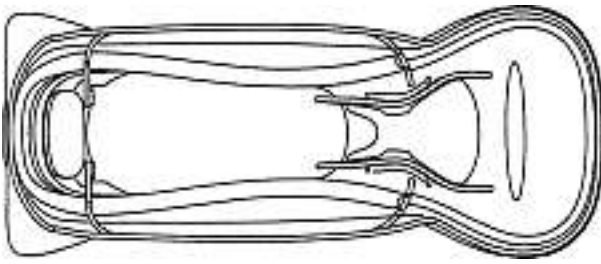

2

Cl. 31-00 132 726 08.03.2006
1 design - distributeur de boissons
Déposant: Société des Produits Nestlé SA, 1800 Vevey
Designer: Kevin Hodges, Leicester
Mandataire: Nestec S.A., 1800 Vevey

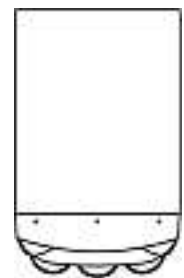
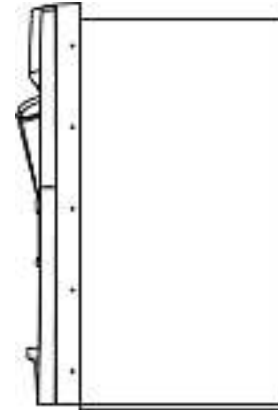
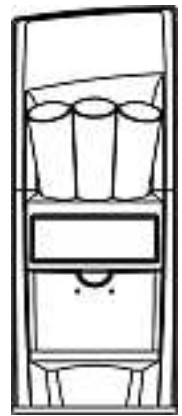
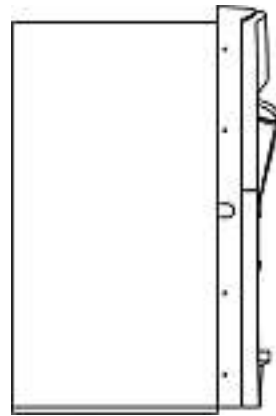

FL 60685

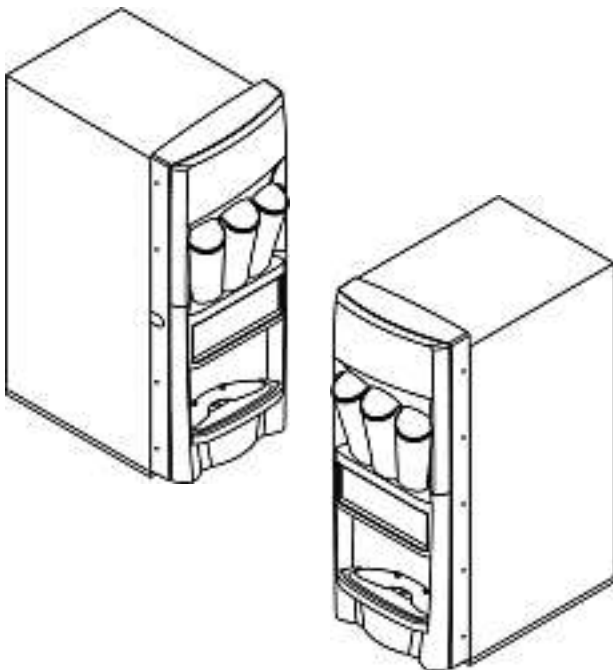

Verlängerungen Prolongations Prolongazioni

118 547 Cl. 10-02 1 Design



3

119 121 Cl. 21-01 1 Design



1

123 246	Cl.	09-03	2 Design
123 270	Cl.	28-03	2 Design
123 275	Cl.	06-03	4 Design
123 276	Cl.	06-04	1 design
123 355	Cl.	14-02	1 Design
123 359	Cl.	16-03	1 Design
123 360	Cl.	16-03	1 Design
123 401	Cl.	21-02	1 Design
123 405	Cl.	24-02	1 Design
123 442	Cl.	09-05	1 Design
123 502	Cl.	21-02	2 Design
123 503	Cl.	21-02	2 Design
123 540	Cl.	06-01	2 Design
127 906	Cl.	06-03	8 Design
127 983	Cl.	11-01	100 Design
127 986	Cl.	14-02	1 design
127 987	Cl.	14-02	2 design
127 988	Cl.	14-02	6 design
128 001	Cl.	28-03	1 Design
128 015	Cl.	09-05	1 design
128 018	Cl.	10-04	6 design
128 032	Cl.	19-06	2 Design
128 172	Cl.	26-05	1 Design
128 194	Cl.	28-03	1 design

Mutationen Modifications Modificazioni

123 246

Vertreter Firmaänderung
Vertreter: Schmauder & Partner AG, Patentanwälte VSP,
8038 Zürich

124 050

124 052

124 061

Nouveau mandataire

Mandataire: Inteltech SA, 2001 Neuchâtel

128 953

128 954

Übertragung

Hinterleger: Hitachi Global Storage Technologies Japan, Ltd.,
2880 Kozu, Odawara-shi, Kanagawa-ken, JP

Vertreter: Ammann Patentanwälte AG Bern, 3001 Bern

Löschungen
Radiations
Radiazioni

118 485	Cl.	11-02	1 Design
118 640	Cl.	07-02	1 Design
118 641	Cl.	07-02	1 Design
118 645	Cl.	09-01	2 Design
122 688	Cl.	06-06	7 Design
122 734	Cl.	06-06	1 Design
122 736	Cl.	06-08	1 Design
122 737	Cl.	06-09	1 Design
122 747	Cl.	09-01	63 Design
122 748	Cl.	09-03	1 design
122 750	Cl.	09-04	1 Design
122 784	Cl.	10-07	4 Design
122 785	Cl.	10-07	1 Design
122 818	Cl.	07-05	1 Design
127 372	Cl.	09-01	7 Design
127 373	Cl.	09-03	2 Design
127 385	Cl.	14-02	1 design
127 388	Cl.	15-05	4 Design
127 408	Cl.	02-02	17 Design
127 411	Cl.	06-04	1 design
127 412	Cl.	06-04	2 Design
127 416	Cl.	07-04	1 Design
127 418	Cl.	08-05	1 Design
127 419	Cl.	09-03	1 Design
127 420	Cl.	09-03	1 design
127 421	Cl.	09-03	4 Design
127 422	Cl.	09-03	1 Design
127 423	Cl.	09-09	1 Design
127 424	Cl.	10-07	1 design
127 425	Cl.	11-02	3 Design
127 426	Cl.	11-02	1 Design
127 429	Cl.	14-02	1 Design
127 430	Cl.	14-02	1 Design
127 441	Cl.	20-03	1 Design
127 443	Cl.	21-01	2 Design
127 444	Cl.	23-04	1 Design
127 446	Cl.	25-01	3 Design
127 447	Cl.	25-01	1 Design
127 453	Cl.	06-01	1 Design
127 454	Cl.	06-01	1 Design
127 465	Cl.	10-07	22 design
127 467	Cl.	11-01	4 design
127 472	Cl.	14-03	1 design
127 482	Cl.	26-01	2 design
127 516	Cl.	16-06	1 design

Berichtigungen
Rectifications
Rettifiche

132 664
 Rectification du nom du déposant
 Montres Choisi S. A.