

Nationale Hinterlegungen

In der folgenden Liste werden die beim Eidgenössischen Institut für Geistiges Eigentum hinterlegten Designs publiziert. Dabei sind der Reihe nach angegeben:

- internationale Klassenangaben
- Hinterlegungsnummer
- Hinterlegungsdatum
- Allenfalls Aufschub der Veröffentlichung
- Anzahl der hinterlegten Designs
- Bezeichnung
- Name und Wohnsitz des Hinterlegers oder der Hinterlegerin
- gegebenenfalls Name und Wohnsitz des Designers oder der Designerin
- Name und Geschäftssitz des allfälligen Vertreters oder der Vertreterin
- gegebenenfalls Prioritätsangaben
- gegebenenfalls Beschreibungstext
- Ordnungsnummer
- Reproduktion des Designs

Internationale Hinterlegungen

Die bei der Weltorganisation für geistiges Eigentum in Genf hinterlegten Muster und Modelle mit Benennung Schweiz geniessen den gleichen Schutz wie national hinterlegte Designs. Sie werden jeweils im Blatt «Bulletin des dessins et modèles internationaux» veröffentlicht. Dieses Publikationsorgan ist deshalb für eine vollständige Recherche unbedingt beizuziehen.

Topographien

Angaben über die vom Eidgenössischen Institut für Geistiges Eigentum eingetragenen Topographien von Halbleitererzeugnissen werden in folgender Anordnung aufgeführt:

- Eintragsnummer
- Anmeldedatum
- Bezeichnung
- Name und Wohnsitz des Anmelders oder der Anmelderin
- gegebenenfalls Name und Wohnsitz des Herstellers oder der Herstellerin
- Name und Geschäftssitz des oder der allfälligen Bevollmächtigten
- Datum und Ort einer allfälligen ersten geschäftlichen Verbreitung der Topographie

Dépôts nationaux

Les designs déposés à l'Institut Fédéral de la Propriété Intellectuelle sont publiés dans la liste qui suit. Les indications y relatives sont mentionnées dans cet ordre:

- indications des classes internationales
- numéro de dépôt
- date de dépôt
- le cas échéant, ajournement de la publication
- nombre des designs déposés
- désignation
- nom et domicile du/de la déposant/e
- le cas échéant, nom et domicile du/de la designer
- nom et domicile de l'éventuel/le mandataire
- le cas échéant, indication de priorité
- le cas échéant, description du design
- numéro attribué à chaque design
- reproduction du design

Dépôts internationaux

Les dessins et modèles déposés à l'Organisation Mondiale de la Propriété Intellectuelle à Genève qui désignent la Suisse jouissent de la même protection que les dépôts nationaux. Ils sont chaque fois publiés dans la feuille «Bulletin des dessins et modèles internationaux». Pour une recherche complète, il est indispensable de consulter ledit organe de publication.

Topographies

Les indications concernant les topographies des produits semi-conducteurs, enregistrées par l'Institut Fédéral de la Propriété Intellectuelle, sont énumérées dans l'ordre suivant:

- numéro d'enregistrement
- date de dépôt
- désignation
- nom et domicile du/de la déposant/e
- le cas échéant, nom et domicile du/de la producteur/trice
- nom et domicile de l'éventuel/le mandataire
- date et lieu d'une éventuelle première mise en circulation de la topographie

Depositi nazionali

Nella lista seguente vengono pubblicati i design depositati presso l'Istituto Federale della Proprietà Intellettuale. Sono menzionati nel seguente ordine:

- indicazioni delle classi internazionali
- numero di deposito
- data del deposito
- se del caso, indicazione che la pubblicazione è stata differita
- numero dei design depositati
- designazione
- nome e domicilio del depositante
- se del caso, nome e domicilio del designer
- nome e sede di un eventuale mandataro
- se del caso, indicazioni di priorità
- se del caso, descrizione del design
- numero d'ordine
- riproduzione del design

Depositi internazionali

I disegni e modelli depositati presso l'Organizzazione Mondiale della Proprietà Intellettuale a Ginevra con denominazione Svizzera godono della medesima protezione del deposito nazionale. Essi vengono pubblicati ogni volta nel foglio «Bulletin des dessins et modèles internationaux». Quest'organo di pubblicazione è da consultare se si vuole effettuare una ricerca completa.

Topografie

Le indicazioni concernenti le topografie di prodotti a semiconduttori depositati presso l'Istituto Federale della Proprietà Intellettuale sono menzionate nell'ordine seguente:

- numero di registrazione
- data del deposito
- designazione
- nome e domicilio del/la richiedente
- se del caso, nome e domicilio del/la produttore/trice
- nome e sede di un eventuale mandataro
- data e luogo di un'eventuale prima messa in circolazione della topografia

Hinterlegungen
Dépôts
Depositi

Cl. 06-01 **131 111** 06.10.2004
 1 Design – Polstermöbel
 Hinterleger: Intertime AG, Polstermöbelfabrik, Brühlstrasse
 21, 5304 Endingen
 Designer: Louis Schneider, Lengnau
 Ende aufgeschobene Publikation



2580



Cl. 06-01 **131 115** 08.10.2004
 1 Design – Polstermöbel
 Hinterleger: Intertime AG, Polstermöbelfabrik,
 Brühlstrasse 21, 5304 Endingen
 Designer: Louis Schneider, Lengnau
 Ende aufgeschobene Publikation





2590

Cl. 10-04 **131 135** 05.11.2004
1 Design - Thermometer
Hinterleger: Artsana S.p.A., Via Saldarini Catelli, 1,
Grandate CO, IT
Vertreter: R. A. Egli & Co., Patentanwälte, 8008 Zürich
Ende aufgeschobene Publikation

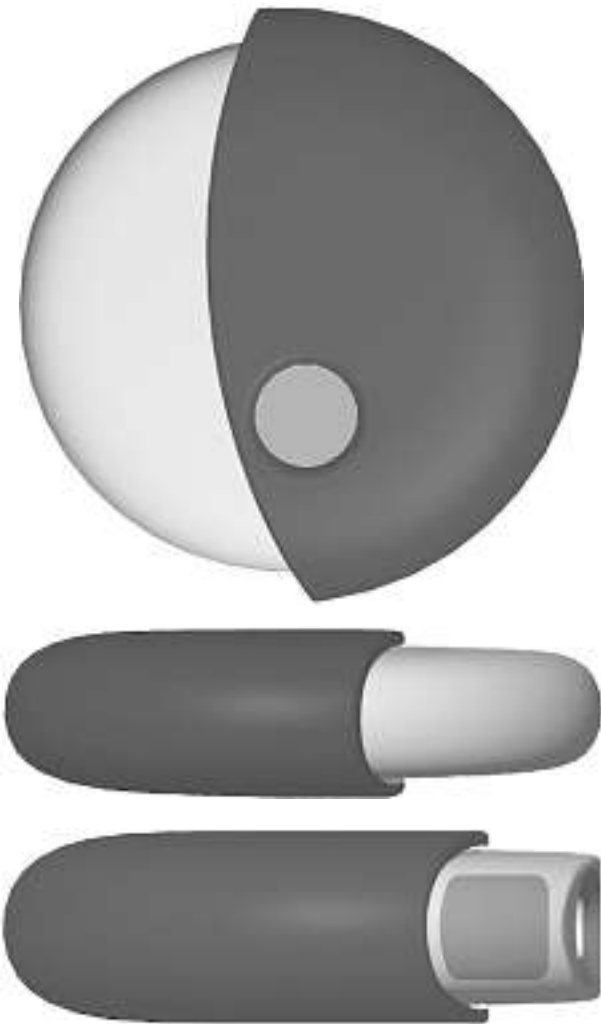
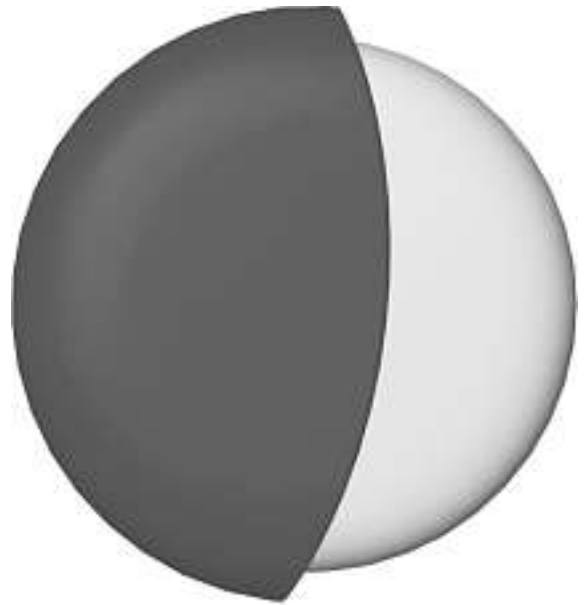

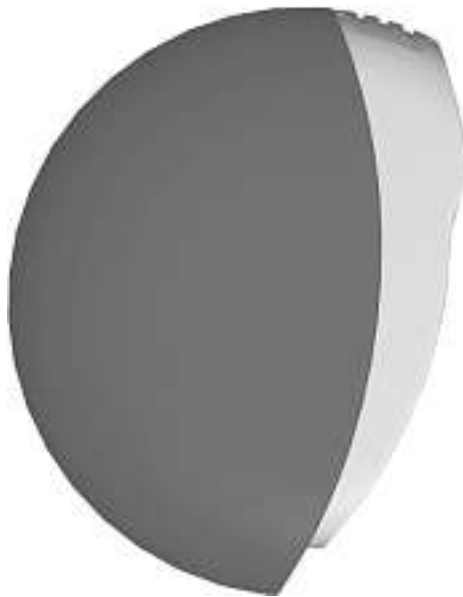

D 4277

Cl. 03-01 132 593 16.02.2006
2 design – porte-monnaie
Déposant: Willi Arpagaus, 39, route de Puplinge,
1241 Puplinge
Mandataire: Kirker & Cie S.A., Ingénieurs-Conseils,
1226 Genève - Thônex
Fin de la période ajournement de la publication



MPM/mr/310049/1

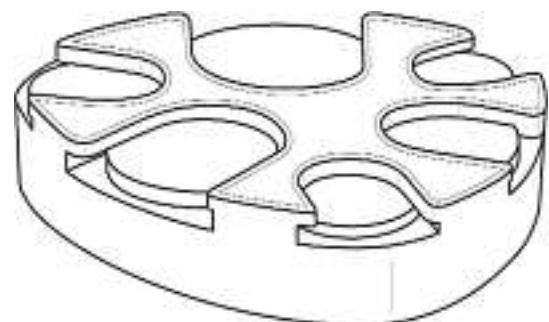

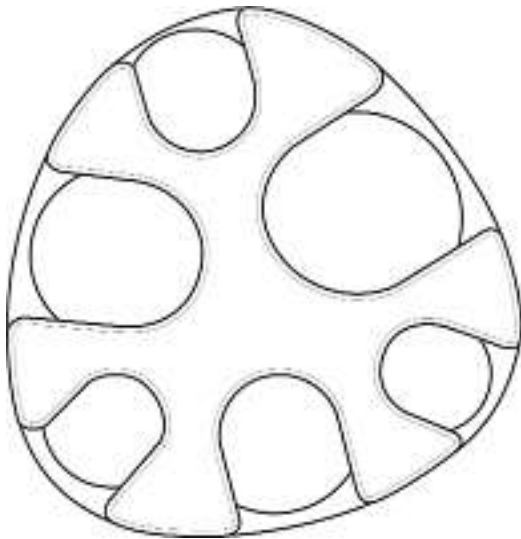

MPM/mr/310049/2

Cl. 21-01 133 355 14.11.2006

1 design – jouet sexuel
 Déposant: LRC Products Limited, 35 New Bridge Street,
 London EC4V 6BW, GB
 Designer: Sean Joseph Tasker, Manchester; Mark Vincent
 Critchley, Manchester; Suren Solanki, Cambridge; John
 Douglas Joyce, Rubi
 Mandataire: Kirker & Cie S.A., Ingénieurs-Conseils,
 1226 Genève - Thônex
 Priorité: EM, 18.05.2006
 Fin de la période ajournement de la publication

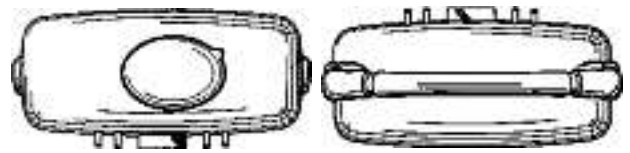
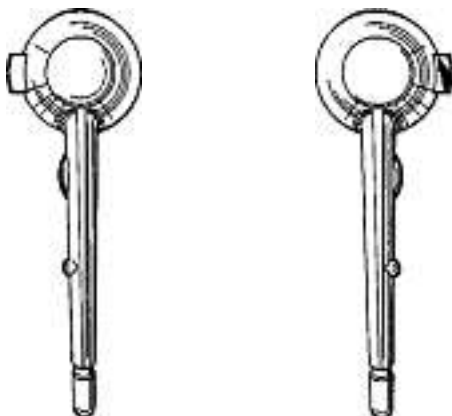
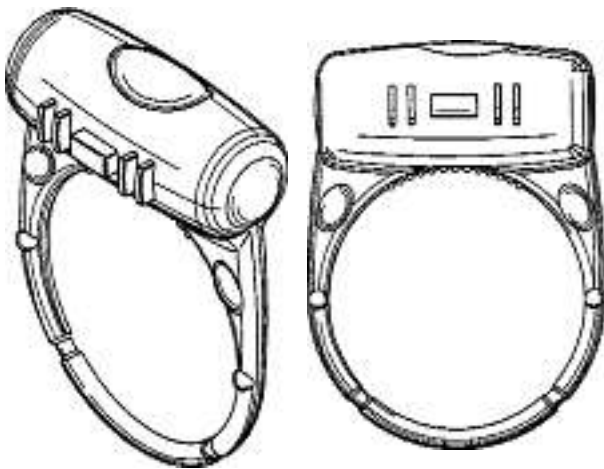

MPM/cl/310481-CH

Cl. 01-01 133 791 04.04.2007

1 design – produits alimentaires
 Déposant: Thierry Navarro, Rte de l'Etraz 1, 1196 Gland

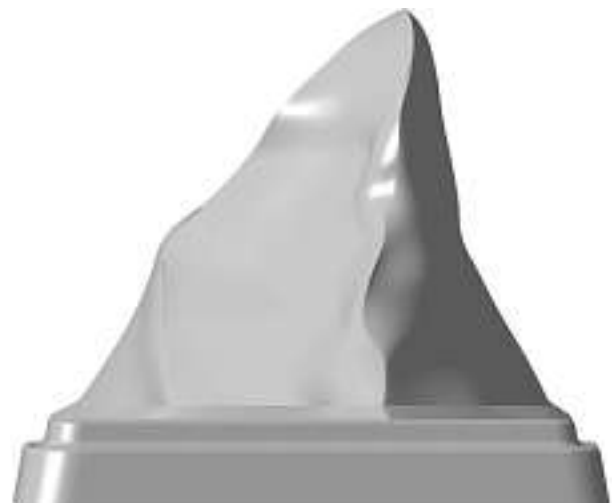

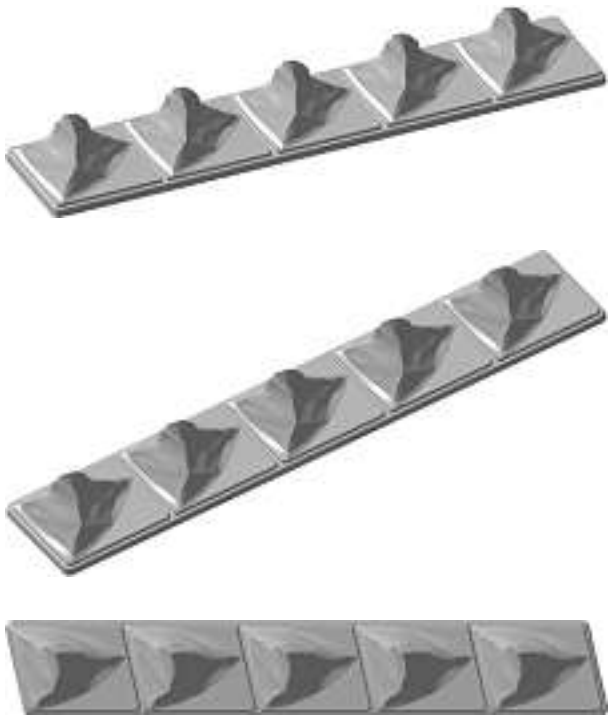

1

Cl. 04-01 133 792 09.03.2007
 1 Design – Flaschenbürste
 Hinterleger: Trisa Holding AG, Kantonsstrasse, 6234 Triengen
 Designer: Pius Thoma, Gommiswald
 Vertreter: Patentanwälte Schaad, Balass, Menzl & Partner AG, 8034 Zürich



1

Cl. 04-01 133 793 19.03.2007
 10 Design – Handwischerformen mit Kratzkanten
 Hinterleger: Bürstenfabrik Ebnat-Kappel AG, Industrie-
 strasse 34, 9642 Ebnat-Kappel
 Designer: Daniel Lutz, Nesslau
 Vertreter: Patentanwälte Schaad, Balass, Menzl & Partner AG, 8034 Zürich



1A



1B



1C



1D



1E



2A



2B



2C



2D



2E

Cl. 04-01 133 794 30.03.2007
 1 Design – Reinigungsbürste
 Hinterleger: Trisa Holding AG, Kantonsstrasse, 6234 Triengen
 Designer: Daniel Lutz, Nesslau
 Vertreter: Patentanwälte Schaad, Balass, Menzl & Partner AG, 8034 Zürich

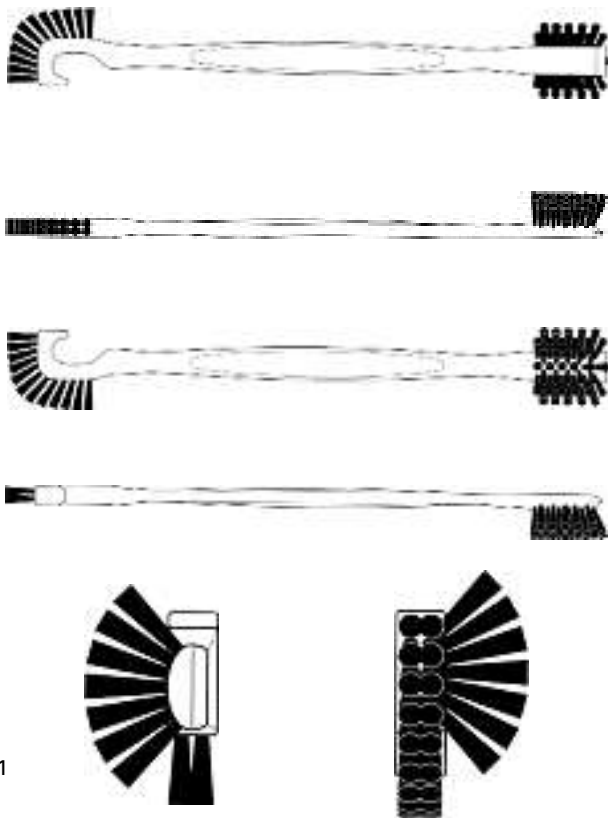

1

Cl. 06-01 133 795 08.03.2007
 1 Design – Stuhl
 Hinterleger: Design Haefeli GmbH, Buolterlistrasse 22,
 6052 Hergiswil
 Designer: Oliver Haefeli, Zumikon
 Vertreter: Oliver Haefeli, 8126 Zumikon



S1

Cl. 06-01, 06-03, 06-06 133 796 09.03.2007
 37 design – chaises, fauteuils, éléments de meubles, tables,
 banquette-lit, canapés, sièges, poufs, banquettes, tabouret
 Déposant: Double You Meubelcollectie B.V., Minervum
 7388-7390, ZH Breda, NL
 Designer: Sako Wijma, Vuren; Danielle Vosseveld, Utrecht
 Mandataire: William Blanc & Cie, Conseils en Propriété
 Industrielle S.A., 1220 Les Avanchets/Genève



1



2





10



15



11



16



12



17



13



18



14



19



20



21



22



23



24



25

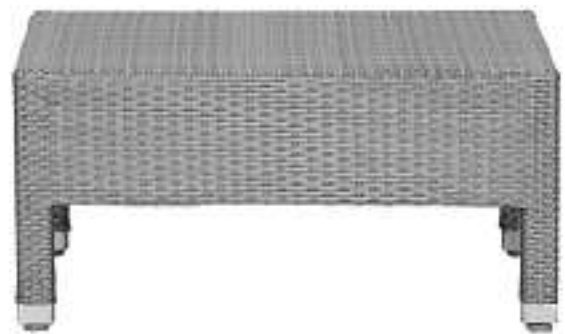

26

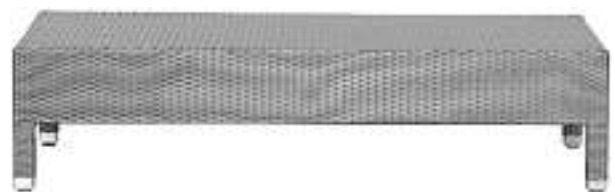

27



28



29



33



30



34



31

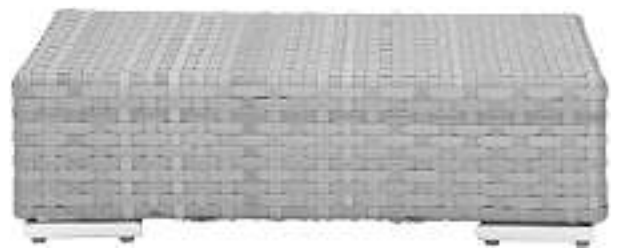

35



32



36



37



F-D-50681-CH/1

Cl. 06-01 133 797 21.03.2007
 4 Design – Sofas
 Hinterleger: MCA-Agentur Establishment, Industriestrasse 4,
 Bendern-Gamprin, LI
 Designer: Patrick Poltera, Bendern-Gamprin
 Vertreter: BÜCHEL, KAMINSKI & PARTNER
 PATENTANWÄLTE ESTABLISHMENT, Vaduz (LI),
 Zweigniederlassung Frümser, 9467 Frümser



F-D-50681-CH/2



F-D-50681-CH/3



F-D-50681-CH/4

Cl. 06-01, 06-03 133 798 29.03.2007
22 Design – Tisch, Tischelemente, Stuhl
Hinterleger: Tisch & Stuhl Willisau AG, Menznauerstrasse 21,
6130 Willisau
Designer: Elsbeth Stöckli, Willisau; Martin Ballendat,
Simbach am Inn; Erwin Bachmann, Beckenried; Ulrich Kössl,
St. Erhard; Lino Amati, Willisau; Rainer Bachschmid, Sarnen



1



2



3



4





5



6



7



8



9



10



11





12

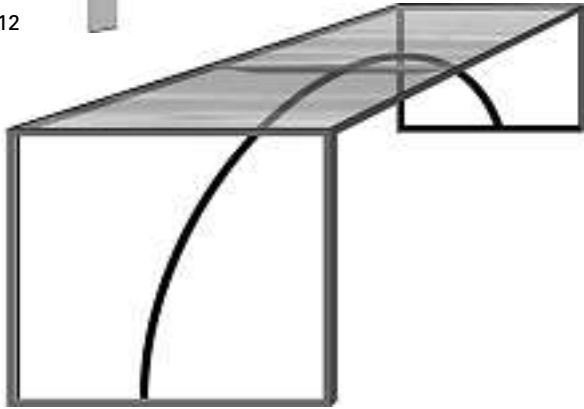

13



14



15



16



17



18



19



20



21



22

Cl. 06-01 133 799 31.03.2007
 1 Design – Barhocker
 Hinterleger: Patrick Imboden, Haus Namaste, 3929 Täsch





Cl. 06-01 133 800 04.04.2007
4 Design – Stühle, Sessel, Sitzbank, Sitzelement
Hinterleger: Dauphin Entwicklungs- u. Beteiligungs GmbH,
Industriestrasse 11, 91217 Hersbruck, DE
Designer: Elke Dauphin, Offenhausen
Vertreter: Peter Rutz, 6304 Zug
Priorität: EM, 13.10.2006





D 1020 CH-5





D 1020 CH-6





D 1020 CH-7



D 1020 CH-8



Cl. 06-04, 06-06 **133 801** 27.03.2007
3 Design – Paneelwand, Sideboard
Hinterleger: ARTE INTERIOR Objekteinrichtung GmbH,
Stralauer Allee 2, 10245 Berlin, DE
Designer: Reiner Heublein, Wilhelmshorst
Vertreter: Meyer Lustenberger, 8032 Zürich
Priorität: EM, 28.09.2006

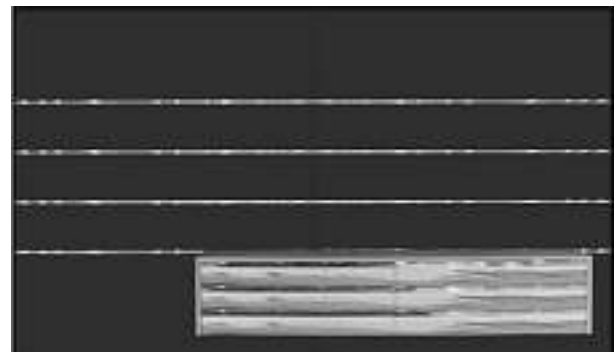

1

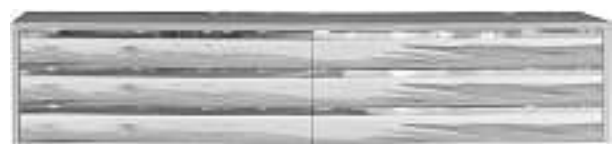

2



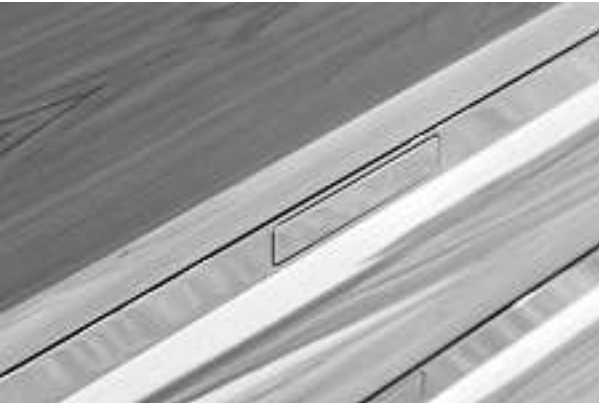

3

Cl. 06-06 133 802 11.03.2007
 1 Design – Armlehne
 Hinterleger: Dauphin Entwicklungs- u. Beteiligungs GmbH,
 Industriestrasse 11, 91217 Hersbruck, DE
 Designer: Elke Dauphin, Offenhausen
 Vertreter: Peter Rutz, 6304 Zug
 Priorität: EM, 15.09.2006





D 1015 CH

Cl. 06-06 133 803 21.03.2007
 4 Design – Tischgestelle
 Hinterleger: Michael Hasse, St. Johannis-Vorstadt 74,
 4056 Basel

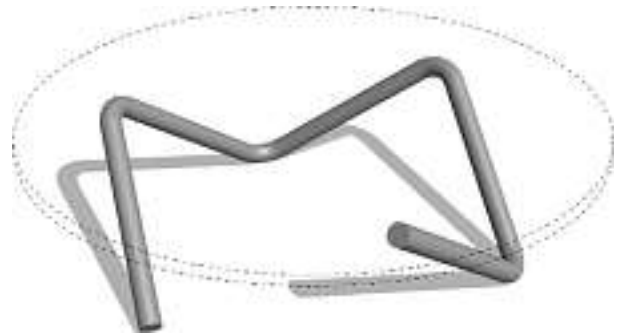

200701 ubu

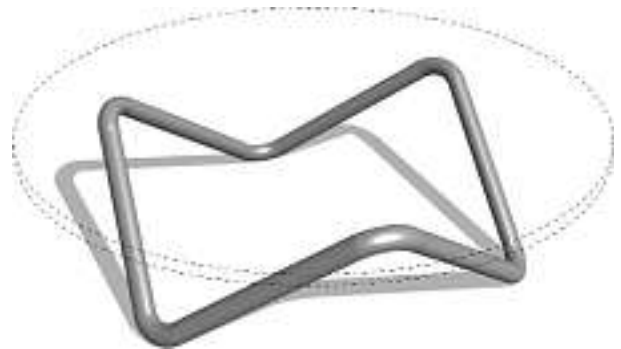

200702 ubuluup

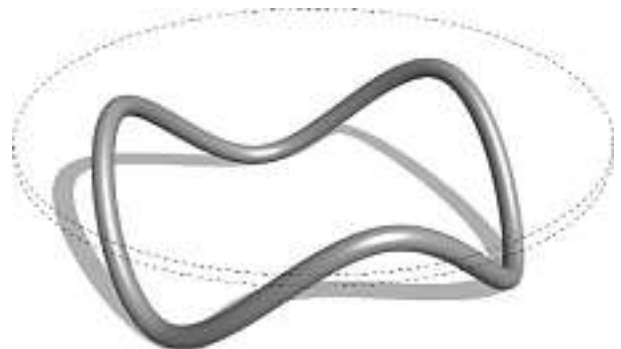

200703 flollop

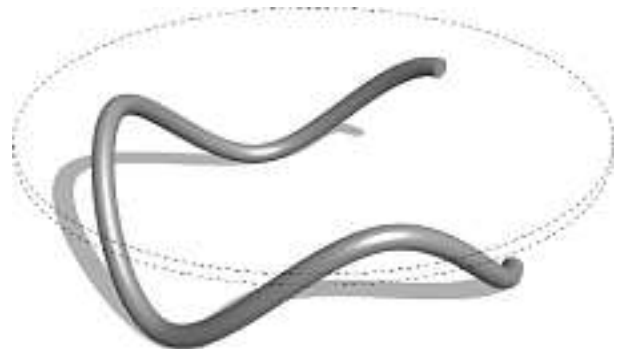

200704 openflollop

Cl. 06-09 133 804 22.03.2007
 1 design – coussin
 Déposant: "Royal Swiss" Montres et Bijoux SA, rue du
 Rhône 23, 1204 Genève
 Designer: Yves Niffeler, Genève
 Mandataire: Griffes Consulting S.A., 1206 Genève



0032-MO-0576-CH-CH-01

Cl. 06-13 133 805 14.03.2007

1 Design – Schlafsack

Hinterleger: Deck 4 GmbH, Mühlebachstrasse 174, 8008 Zürich

Designer: Lukas Imfeld, Zürich

Beschreibung des Designs: Ein Schlafsack der sich im unteren Bereich in zwei Beine teilt.



Schlafsack 07

Cl. 07-02, 07-04 133 806 21.03.2007

20 Design – Backwaren-Schablone, Tranchierbrett

Hinterleger: Betty Bossi Verlag AG, Bürglistrasse 29, Postfach, 8021 Zürich

Designer: Harald Kögel, Wädenswil; Christian Harbeke, Zürich; Oliver Berger, Zürich

Vertreter: Meyer Lustenberger, 8032 Zürich

Beschreibung des Designs: Das Gipfeli-Schablonen-Set besteht aus einer zusammenfaltbaren Schablone, einem Schaber und einem Rezeptbüchlein. Mit dieser Schablone können im Nu aus rund ausgewallten Fertigteigen (Blätter-, Kuchen-, Pizza-, Mürbteig) 16 gleichmässige Gipfeli (Apéro etc.) hergestellt werden.

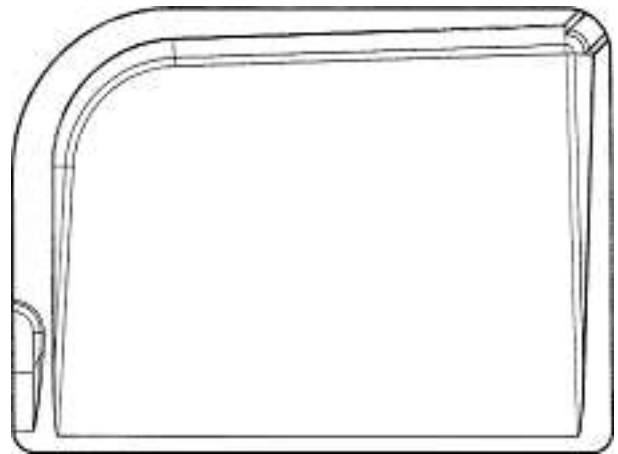

1

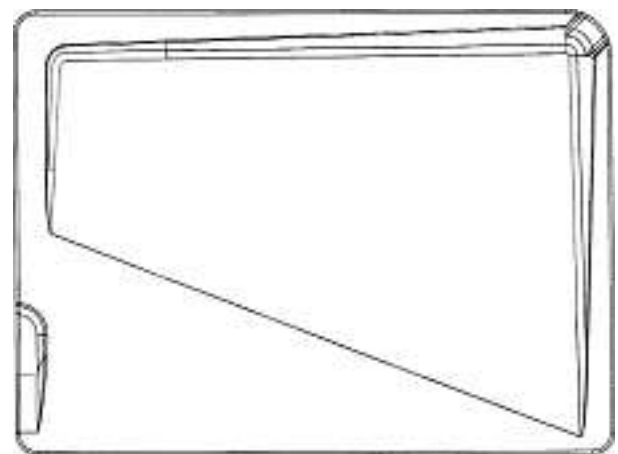

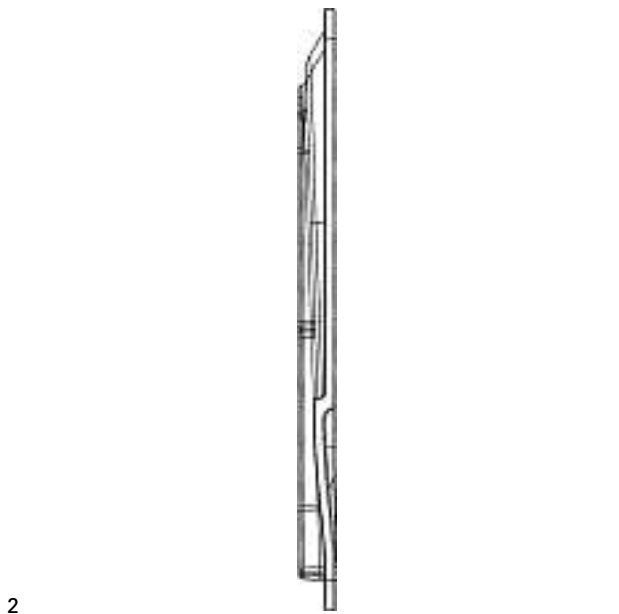

2

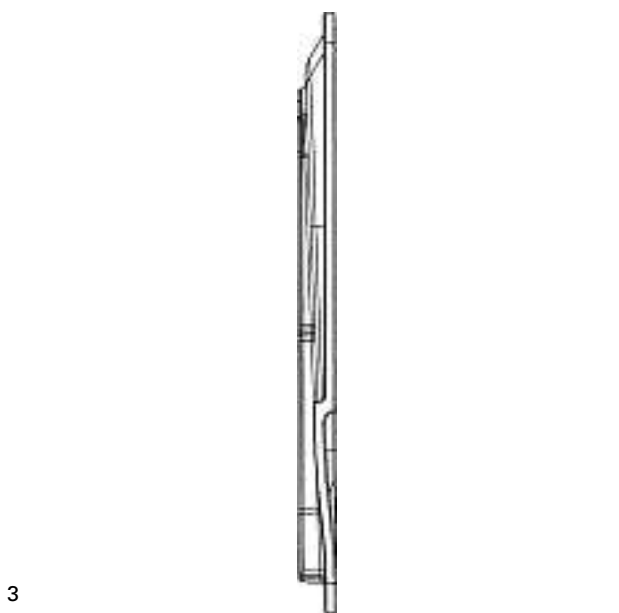
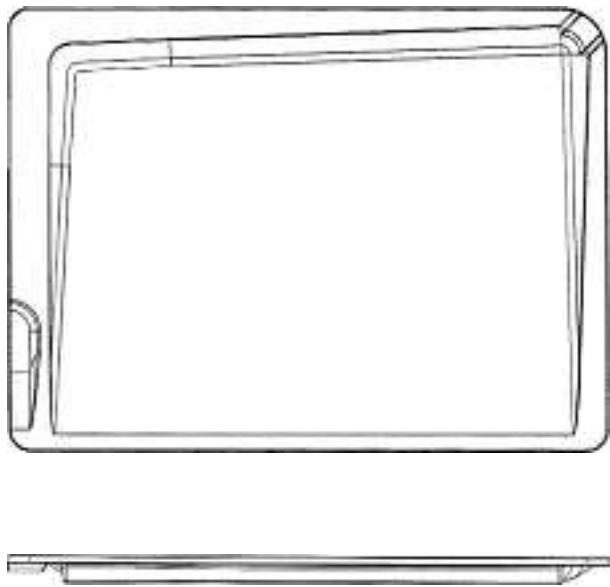

3

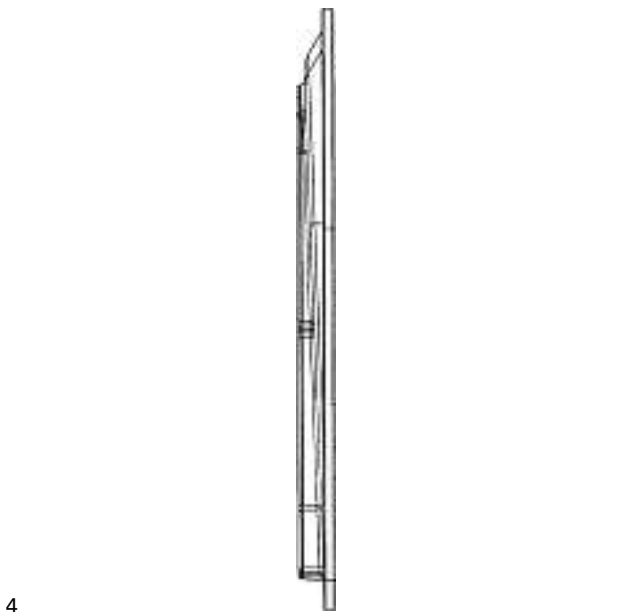
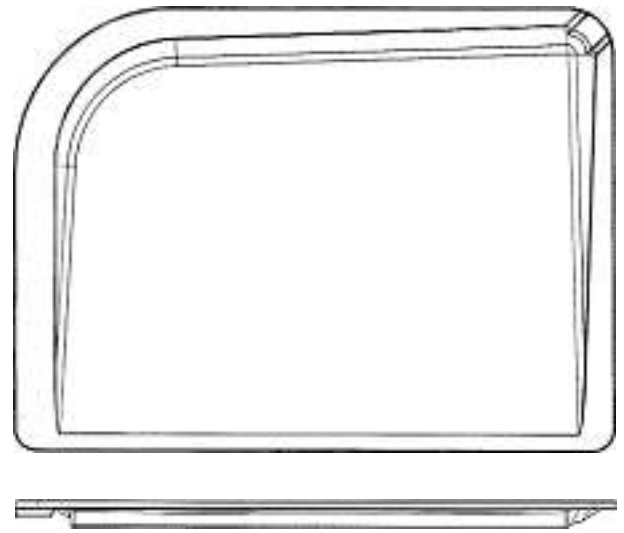

4

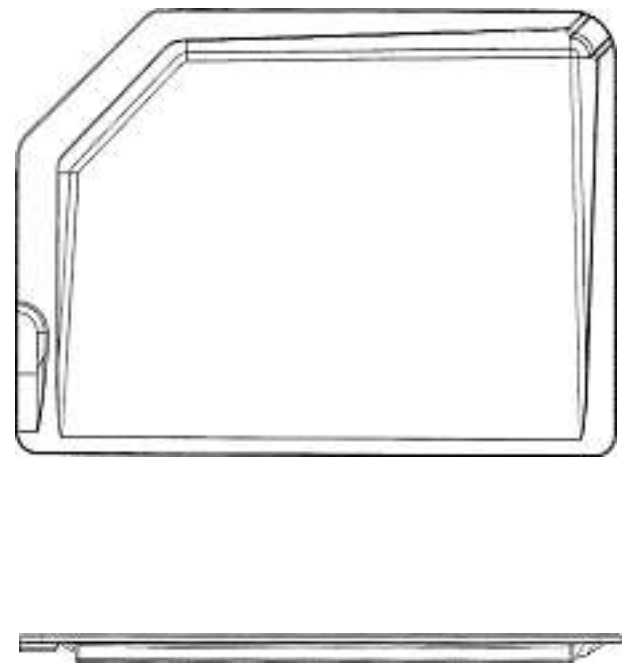

5

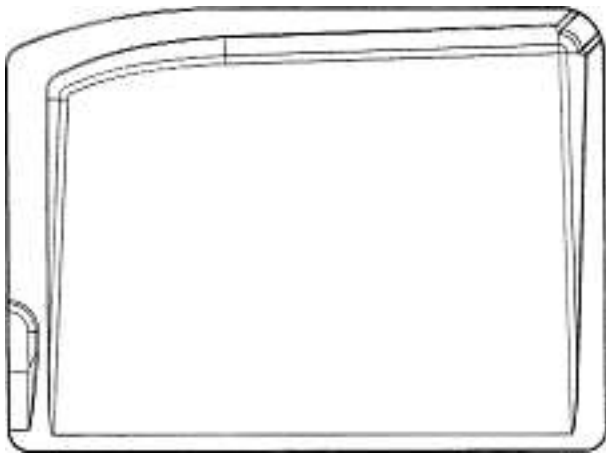

6



7

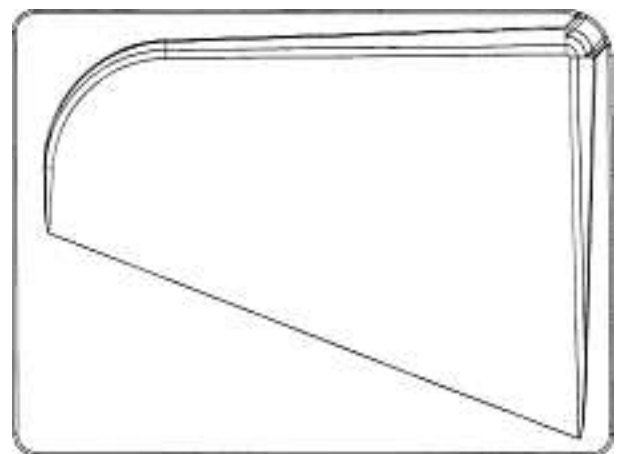
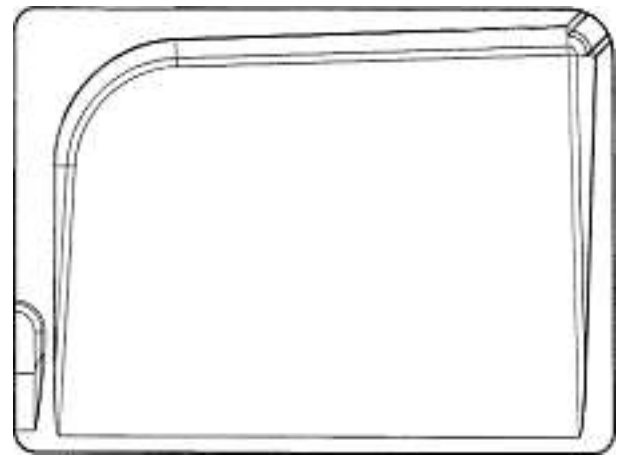

8

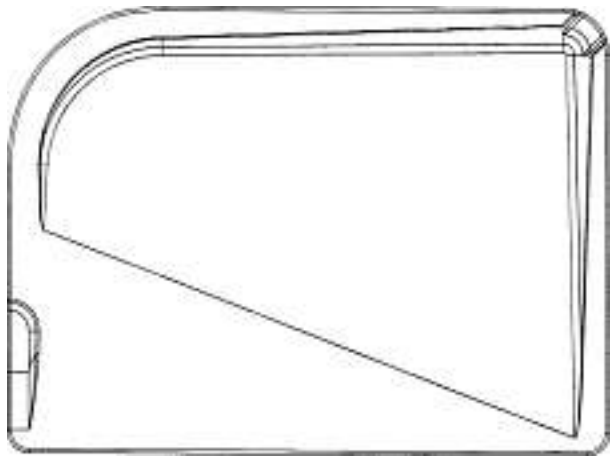

9

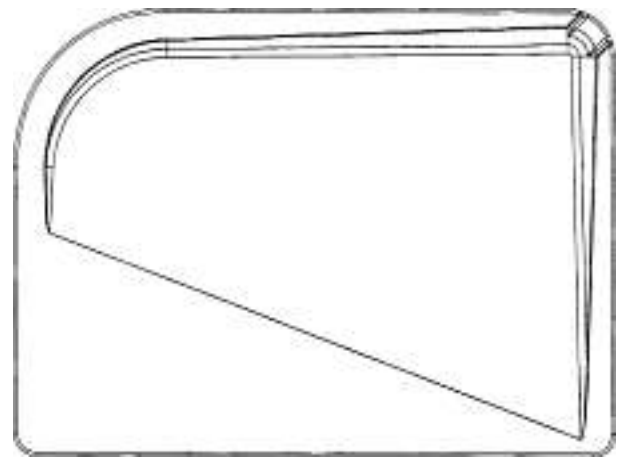

10

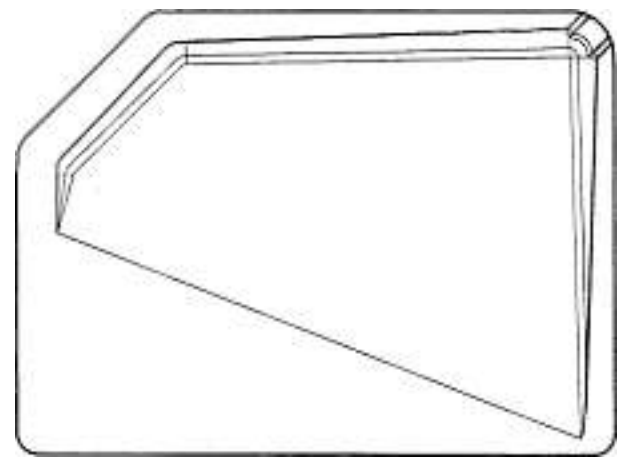

11

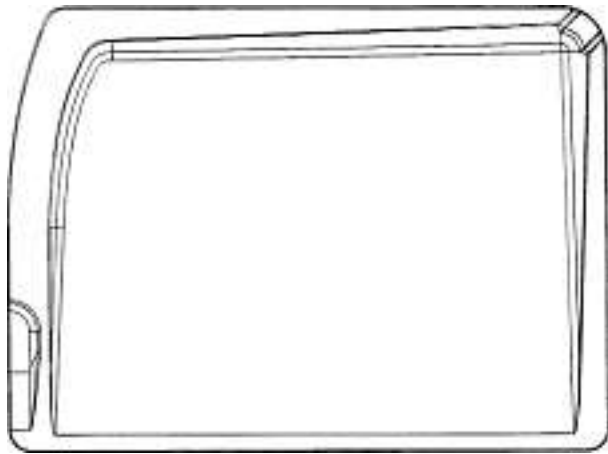

12

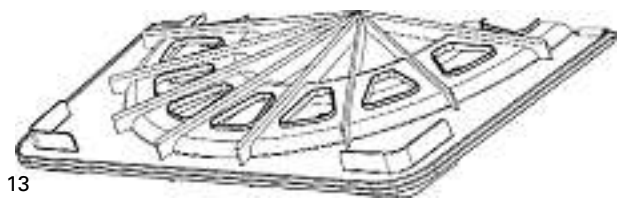
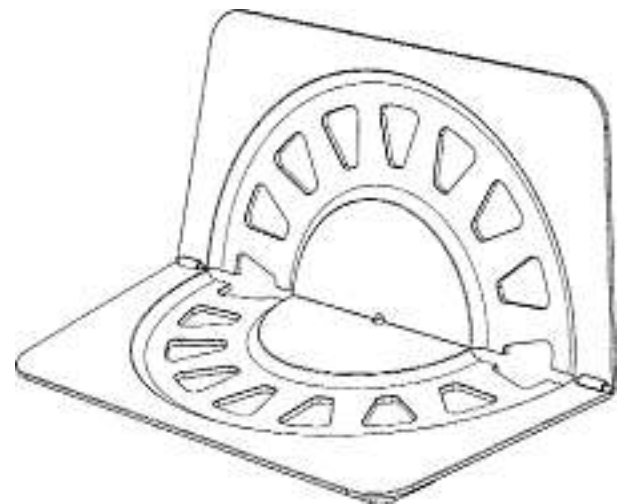
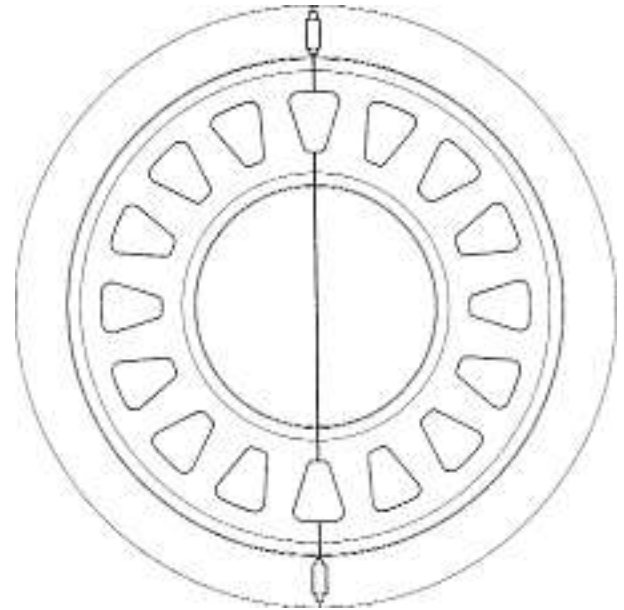

13

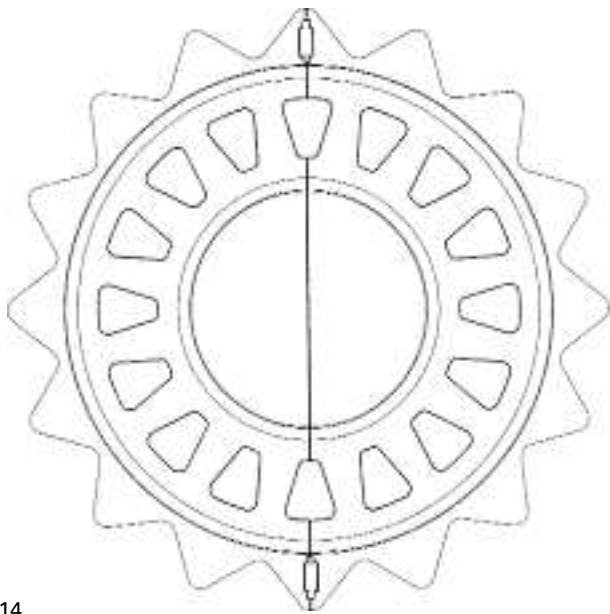

14

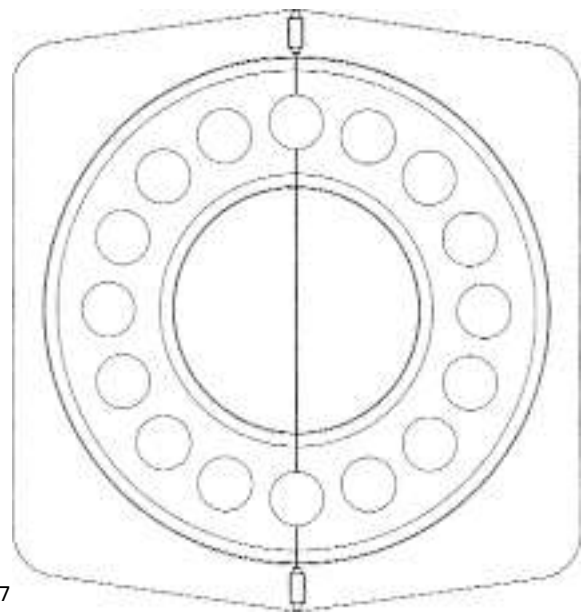

17

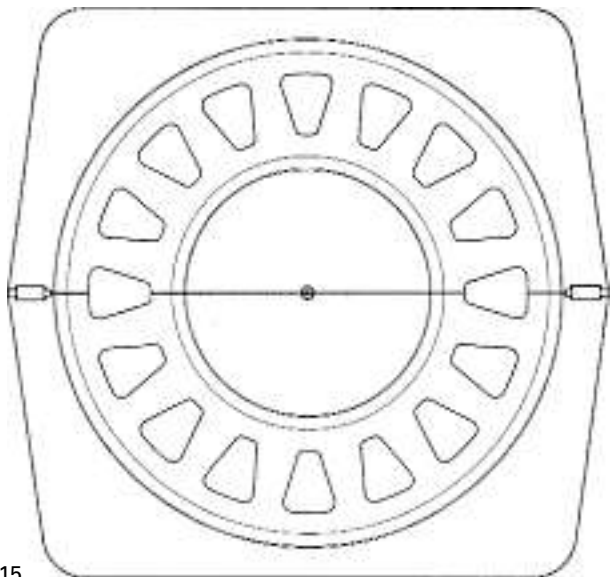

15

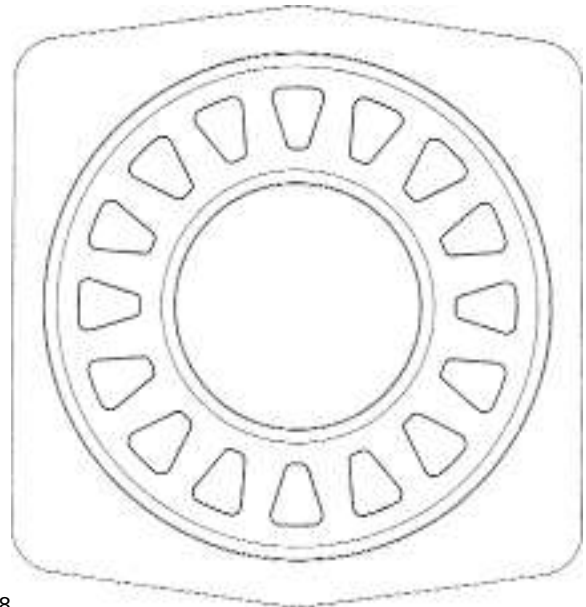

18

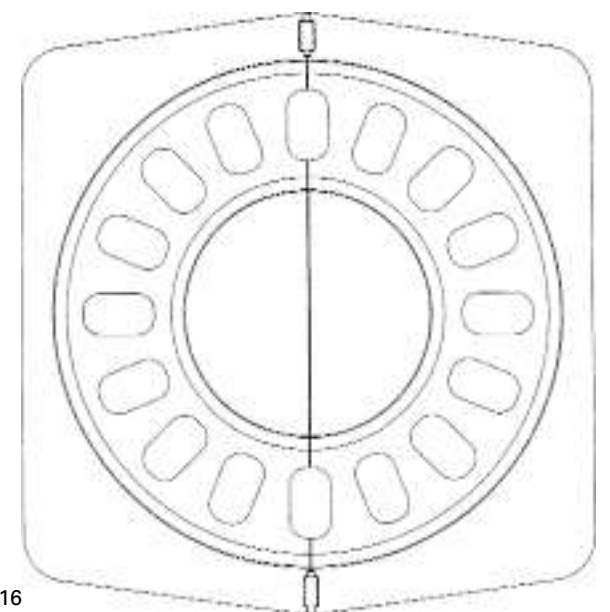

16

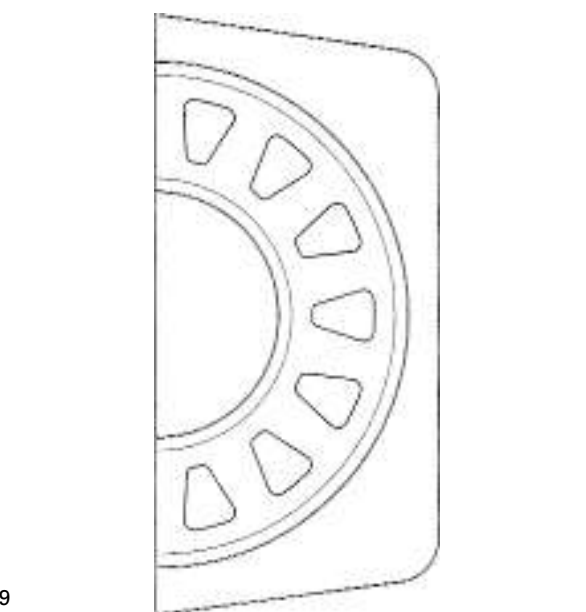

19

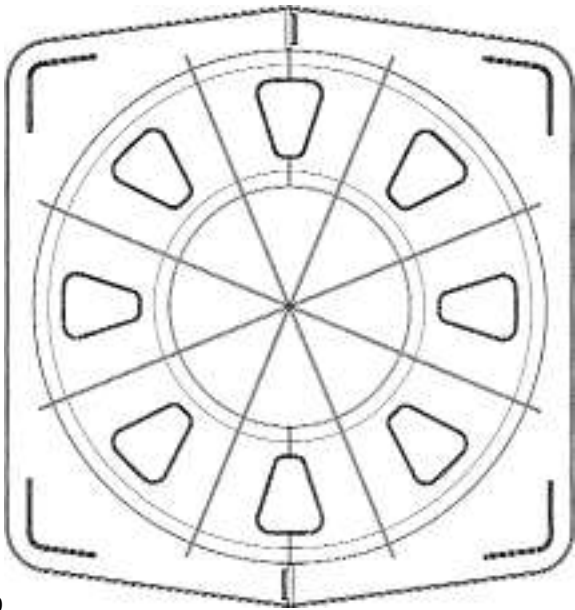

20



Cl. 07-02 133 807 30.03.2007
 1 Design – Kaffeekrug
 Hinterleger: PI-DESIGN AG, Kantonsstrasse 100,
 6234 Triengen
 Designer: Jorgen Bodum, St. Niklausen
 Vertreter: Isler & Pedrazzini AG, 8023 Zürich
 Priorität: DK, 06.10.2006



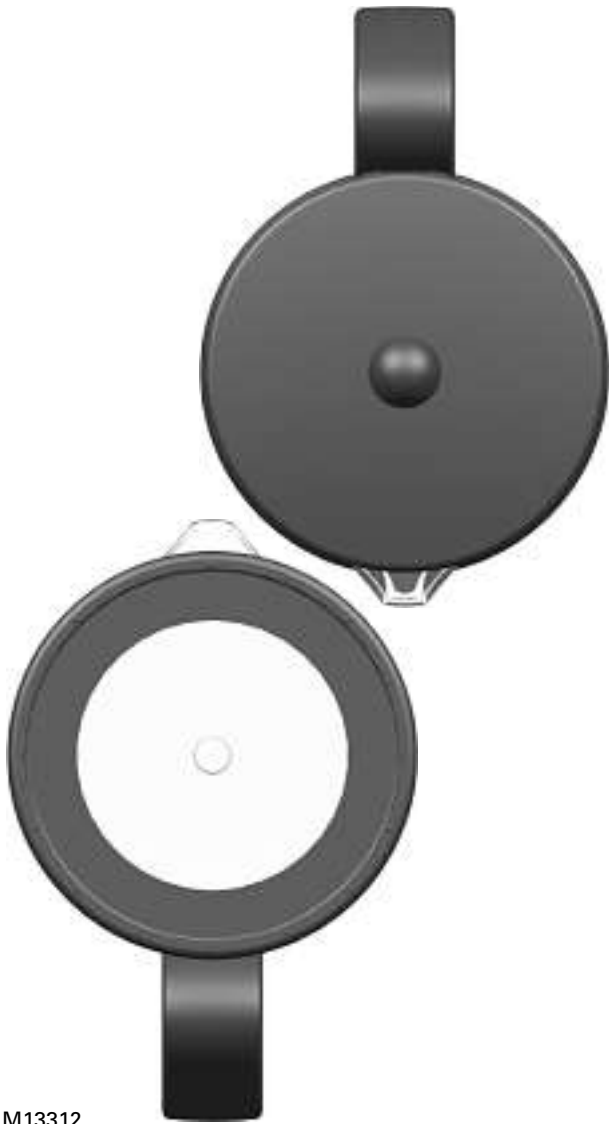

M13312

Cl. 07-02 133 808 04.04.2007
3 design – caquelon, réchaud, ensemble caquelon et réchaud
Déposant: Chocolats et Cacaos Favarger SA, chemin de la
Chocolaterie 2, 1290 Versoix
Designer: Pierre Bijotat, Cessy
Mandataire: Bugnion S.A., 1211 Genève 12 - Champel



1





2



3



Cl. 07-05 133 809 14.03.2007

1 Design – Bezug für Wischmops

Hinterleger: Carl Freudenberg KG, Hühnerweg 2-4,
69469 Weinheim, DE

Designer: Friedel Winterling, Ludwigshafen

Vertreter: Hepp Wenger Ryffel AG, 9500 Wil SG

Priorität: DE, 17.10.2006

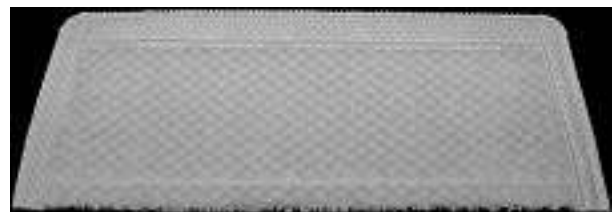

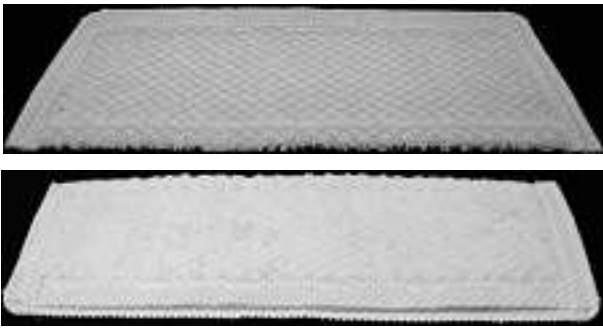

MFRE002CH

Cl. 08-05 133 810 27.03.2007
 1 Design – Giesskanne
 Hinterleger: Deck 4 GmbH, Mühlebachstrasse 174,
 8008 Zürich
 Designer: Sandra Eichmann, Zürich



Giesskanne DUO

Cl. 09-01 133 811 04.04.2007
 1 design – bouteille
 Déposant: Nestlé Waters, 20, Rue Rouget de Lisle,
 92130 Issy-les-Moulineaux, FR
 Designer: Vincent Queffelec, Suresnes
 Mandataire: Nestec S.A., 1800 Vevey
 Priorité: EM, 13.10.2006

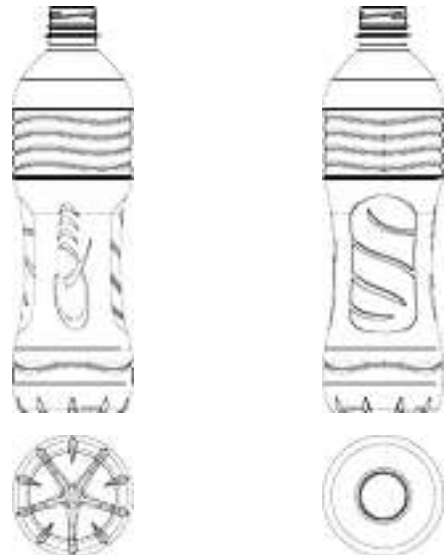

FL 65049

Cl. 09-03 133 812 02.04.2007
 2 Design – Schachtel
 Hinterleger: René Baltensperger, Chätzlerweg 10,
 8311 Brütten
 Vertreter: Hepp Wenger Ryffel AG, 9500 Wil SG

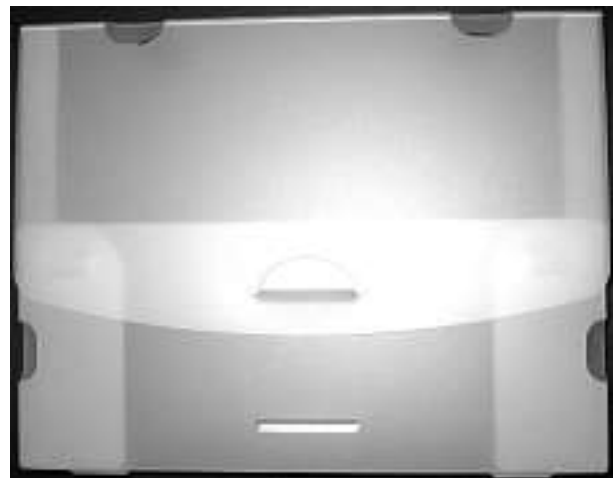



MATB002CH1-7

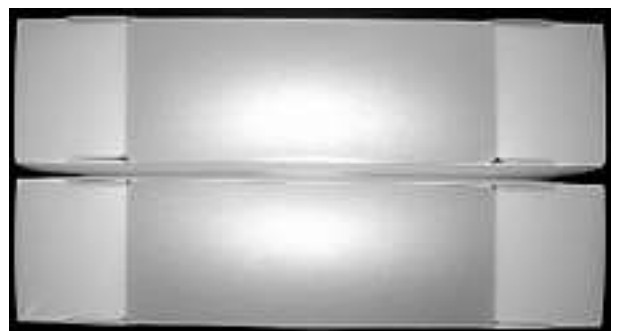
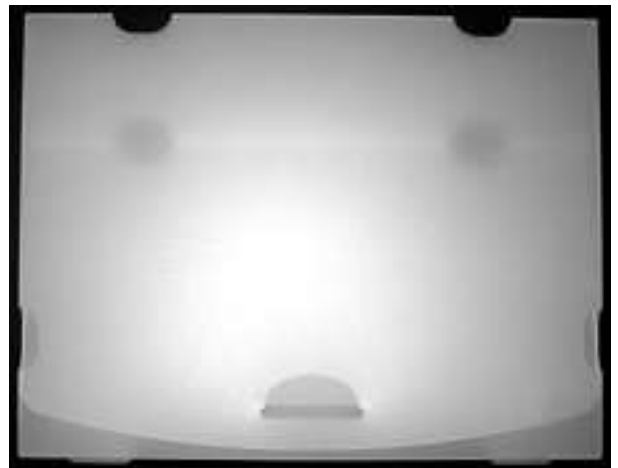
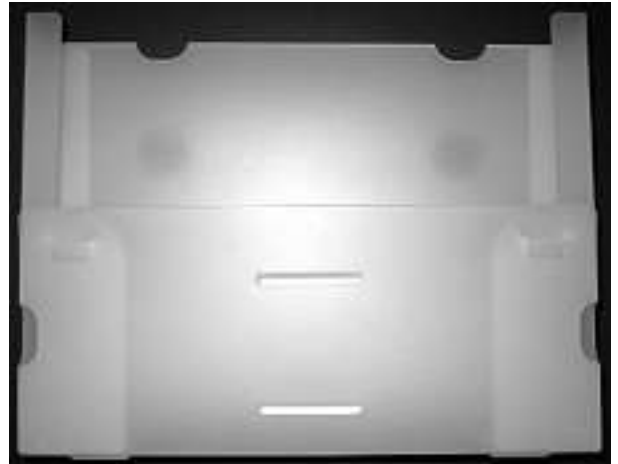

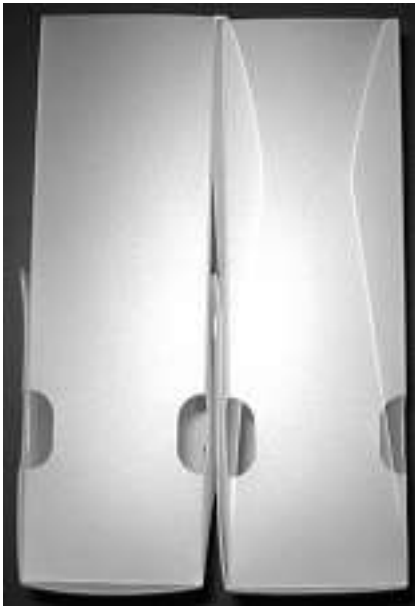

MATB002CH8-14

Cl. 10-02 **133 815** 21.03.2007
 1 Design – Uhr
 Hinterleger: Bucherer Montres S.A., Langensandstrasse 27,
 6002 Luzern
 Designer: Kurt Allemann, Stansstad; Markus Kaiser, Luzern
 Vertreter: Ritscher & Partner AG, 8702 Zollikon



1

Cl. 10-02 **133 816** 29.03.2007
 1 design – montre-bracelet
 Dépositant: Zarine B.V., Prins Bernhardplein 200, 1097 JB
 Amsterdam, NL
 Designer: Franck Dubarry, Miami
 Mandataire: Inteltech SA, 2001 Neuchâtel





Cl. 10-02 133 817 30.03.2007
 1 design – montre
 Déposant: Façonnable SAS, 107, route de Canta Galet,
 Nice, FR
 Designer: Michel Benatar, Mouans-Sartoux
 Mandataire: Griffes Consulting S.A., 1206 Genève



1160-MO-6010-CH-CH-01

Cl. 10-07 133 818 26.02.2007
 6 Design – Zierbogen für Armbanduhren
 Hinterleger: U.T.S. Präzisionstechnik GmbH, Gewerbe-
 strasse 31, 78739 Hardt, DE
 Designer: Hans Uwe Lorius, St. Georgen
 Vertreter: Schneider Feldmann AG, Patent- und
 Markenanwälte, 8022 Zürich
 Priorität: DE, 16.09.2006
 Beschreibung des Designs: Das kennzeichnende
 Designmerkmal bei den Armbanduhren ist der Bogen unter
 der "12".



PRA-001-D-CH-1

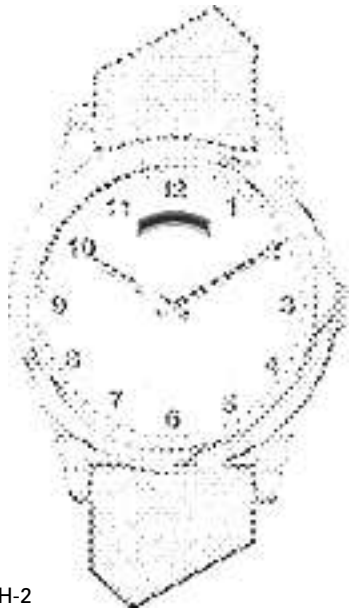

PRA-001-D-CH-2

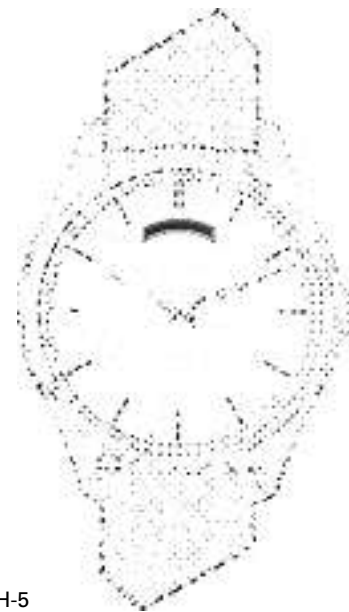

PRA-001-D-CH-5

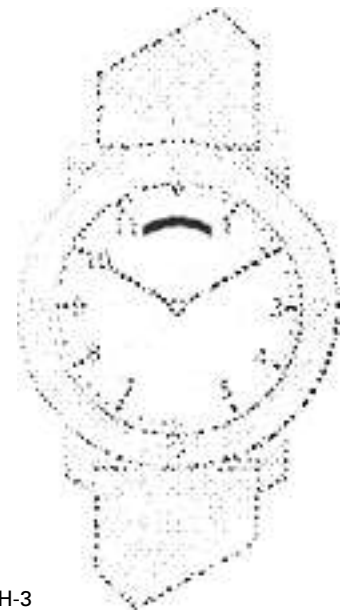

PRA-001-D-CH-3

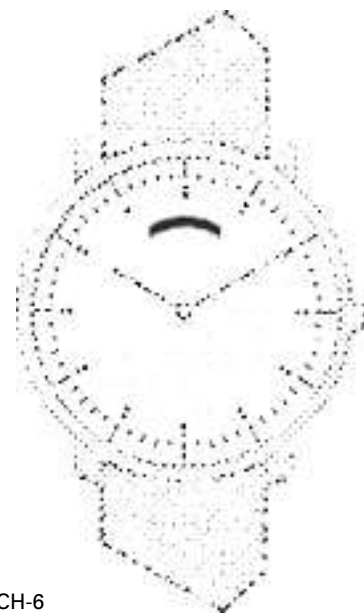

PRA-001-D-CH-6

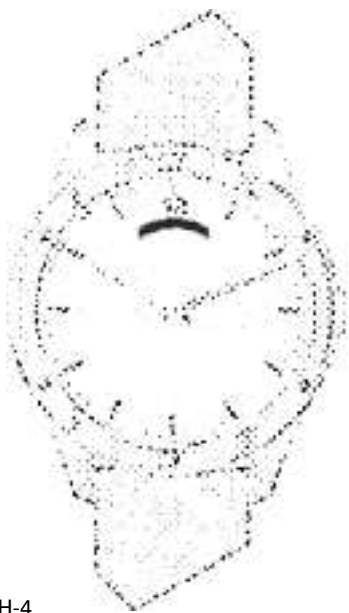

PRA-001-D-CH-4

Cl. 10-07 **133 819** 09.03.2007
5 design – cadrans de montre
Déposant: Spaetig Universe Watches, Rue du Progrès 119,
2301 La Chaux-de-Fonds
Designer: David Spaetig, La Chaux-de-Fonds
Mandataire: Griffes Consulting S.A., 1206 Genève

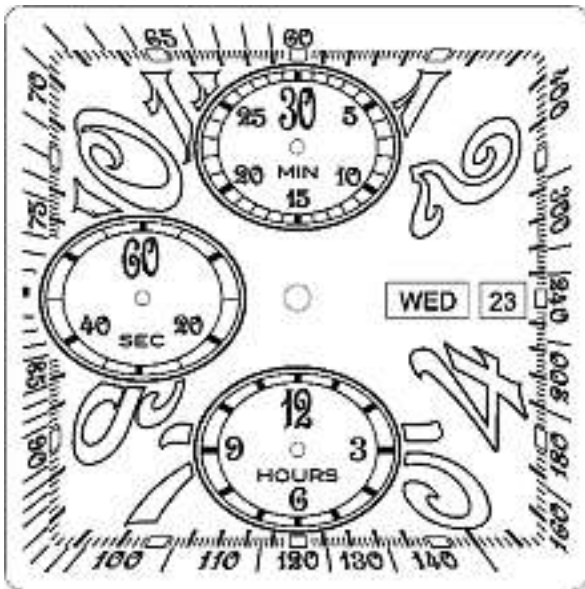

5058-MO-0001-CH-CH-01

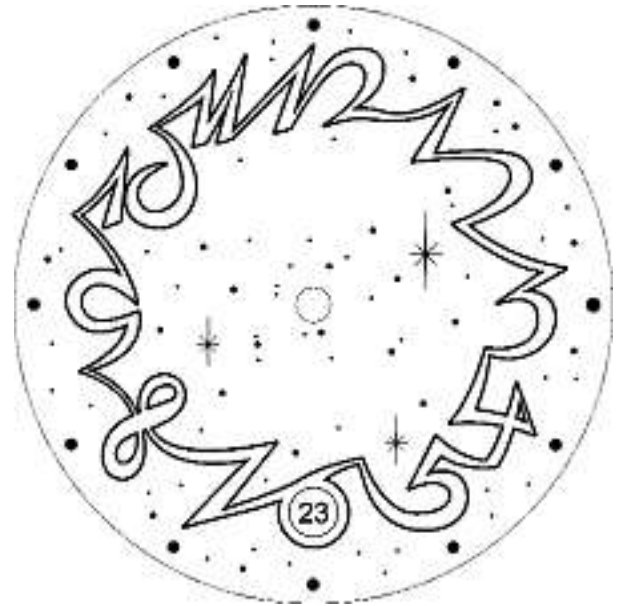

5058-MO-0004-CH-CH-01

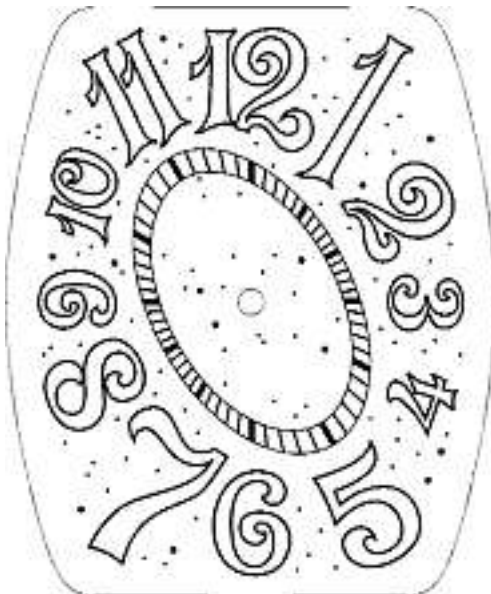

5058-MO-0002-CH-CH-01



5058-MO-0005-CH-CH-01



5058-MO-0003-CH-CH-01

Cl. 10-07 **133 820** 15.03.2007
 3 design – boîtier de montre, cadran de montre, montre
 Déposant: Montres Villemont SA, Chemin du Creux 31,
 1233 Bernex
 Designer: Jorgen Amundsen, Oslo
 Mandataire: Griffes Consulting S.A., 1206 Genève

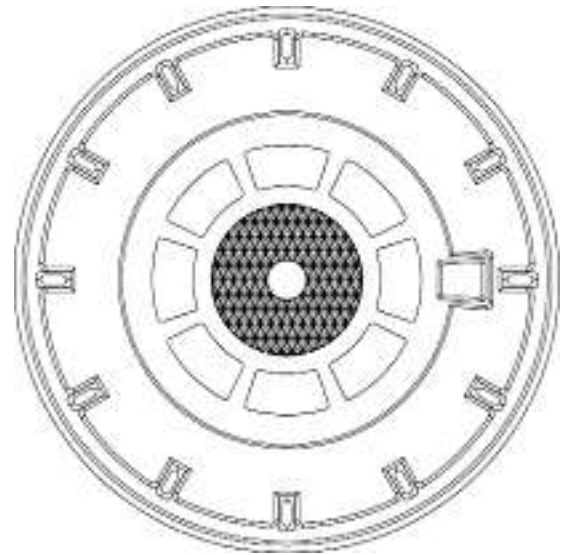
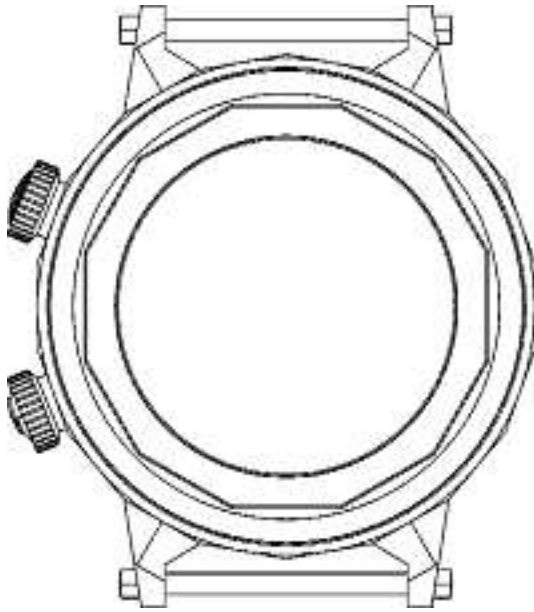

4902-MO-0004-CH-CH-01

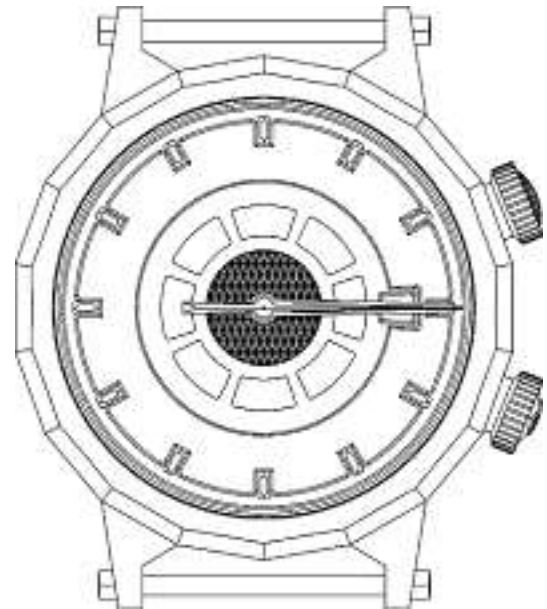
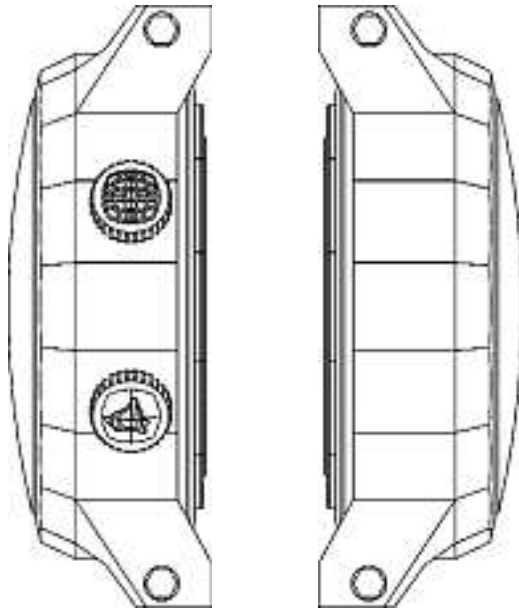

4902-MO-0005-CH-CH-01

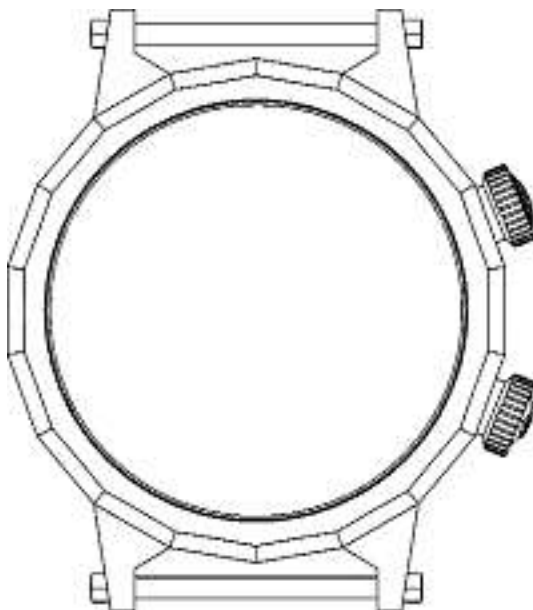

4902-MO-0003-CH-CH-01

Cl. 10-07 **133 821** 21.03.2007
2 Design – Uhrenzifferblatt
Hinterleger: Bucherer Montres S.A., Langensandstrasse 27,
6002 Luzern
Designer: Kurt Allemann, Stansstad; Markus Kaiser, Luzern
Vertreter: Ritscher & Partner AG, 8702 Zollikon





1



2

Cl. 10-07 **133 822** 26.03.2007
 4 design – pièce d’horlogerie
 Déposant: Tiffany & Co. Watch Center AG, Bahnhof-
 strasse 14, 8022 Zürich
 Designer: Steven M. Grotell, New York; Vincente Mafe,
 Buchs; Marc Jenni, Bussigny; Paul Clementi, Pontarlier;
 Stéphane Widmer, Peseux; Melinda Mellman, New York
 Mandataire: Novagraaf International SA, 1220 Les Avanchets
 Priorité: US, 26.09.2006

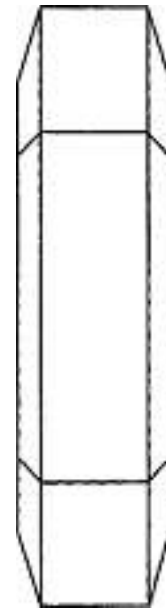
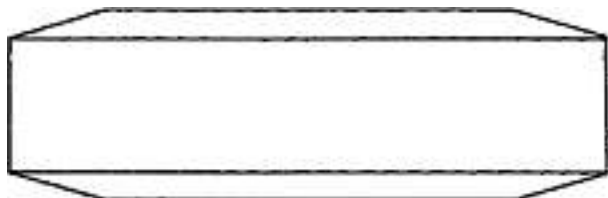
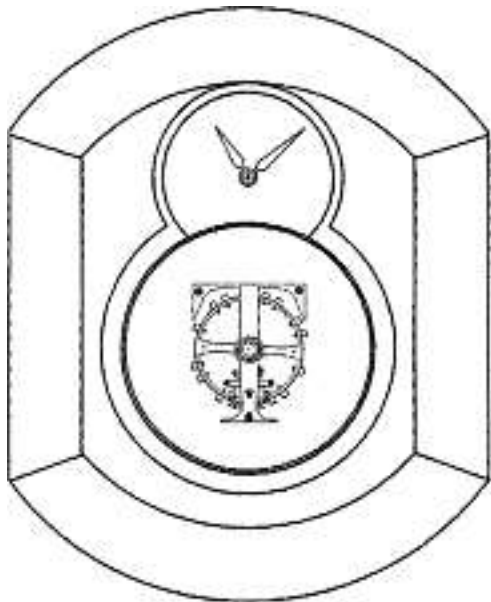

1

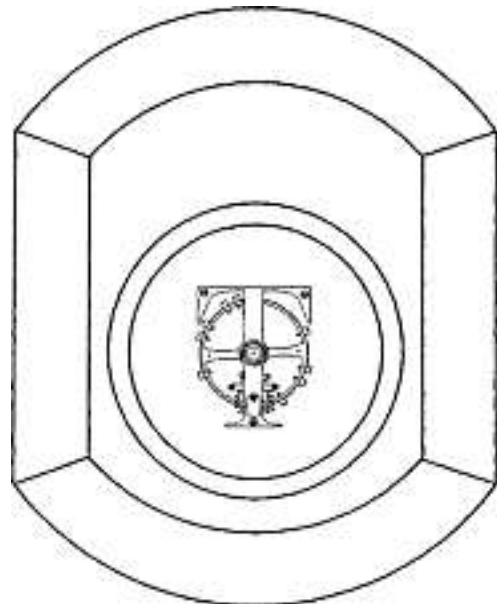

2



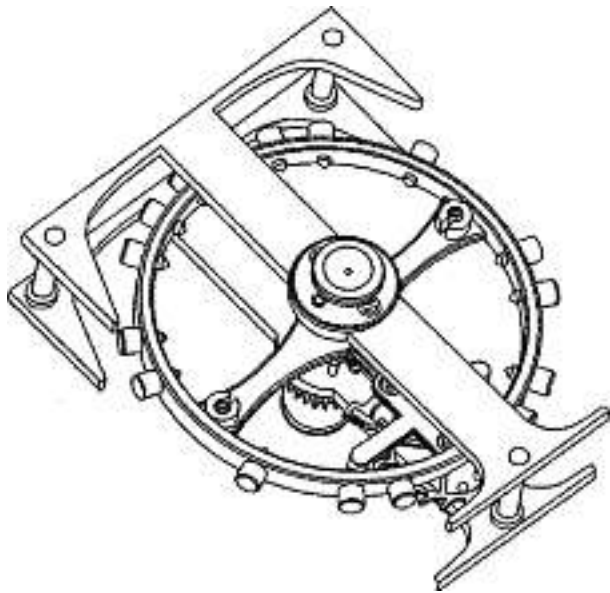

Cl. 10-07 133 823 02.04.2007
1 design – boîte de montre
Déposant: Time 4 Ever Sàrl, La Haute-Route 81,
2502 Biel/Bienne
Designer: Claudio Craighero, Bienne
Mandataire: Albert Rey-Mermet, 1204 Genève

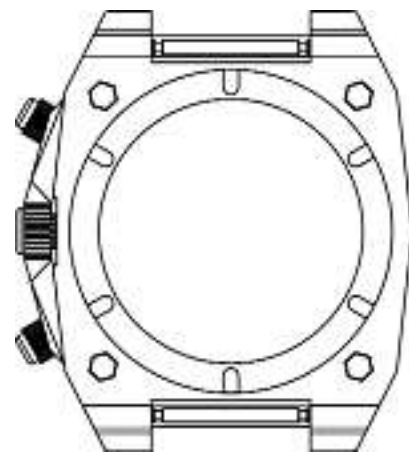
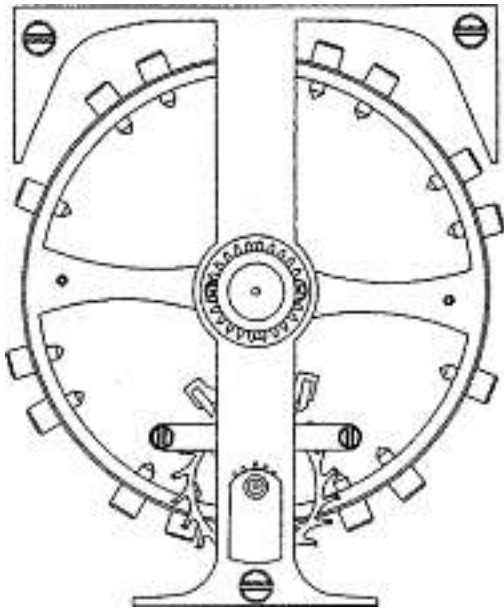
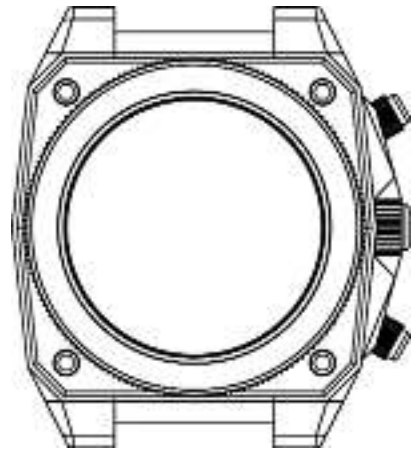

3

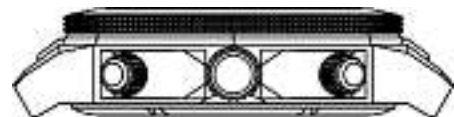
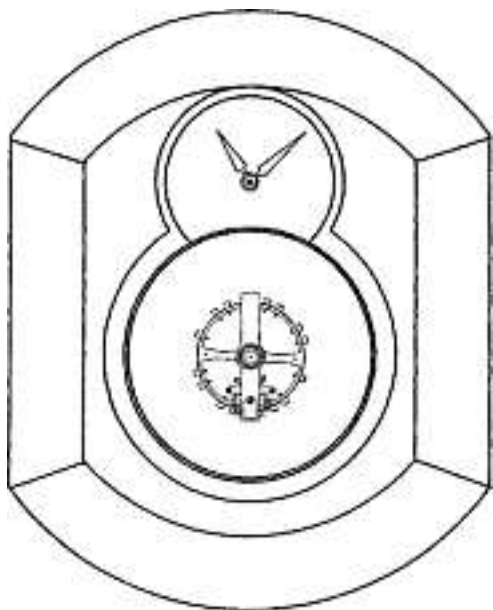
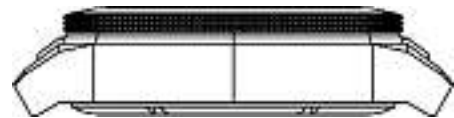

4



T4E II 07

Cl. 11-01 133 824 13.03.2007
 5 Design – Ringe
 Hinterleger: Gérald Scheurer, Schulstrasse 76, 5224 Linn

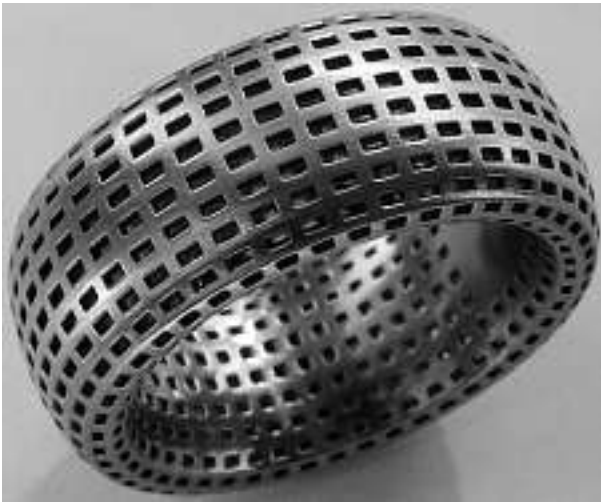

1001



1002



1003



1004



1005

Cl. 11-01 133 825 15.03.2007
 3 Design – Anhänger (Schmuck)
 Hinterleger: Ronzani & Ronzani, Hammerstrasse 58,
 8032 Zürich
 Designer: Caroline Ronzani, Zürich
 Vertreter: Daniel Ronzani, 8032 Zürich





Pendant No. 6

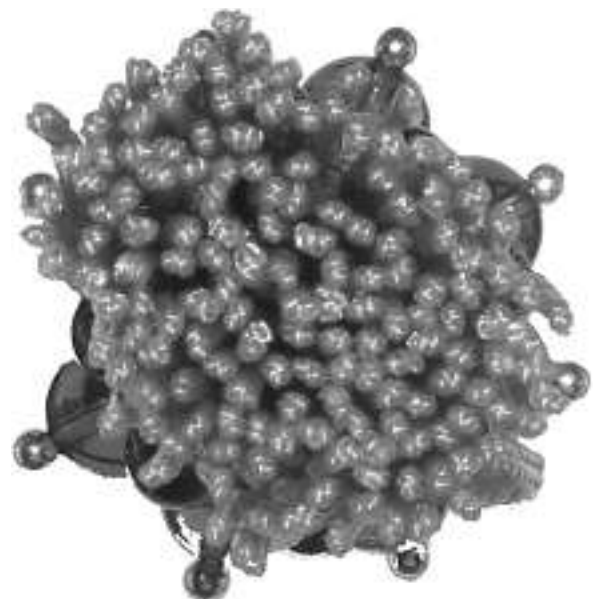

Pendant No. 7



Pendant No. 8

Cl. 11-02 133 826 09.03.2007

2 design – cache-pots

Déposant: Double You Meubelcollectie B.V., Minervum
7388-7390, ZH Breda, NLDesigner: Sako Wijma, Vuren; Danielle Vossebeld, Utrecht
Mandataire: William Blanc & Cie, Conseils en Propriété
Industrielle S.A., 1220 Les Avanchets/Genève

D-16537-CH-1



D-16537-CH-2

Cl. 11-03 133 827 27.02.2007

2 design – insignes

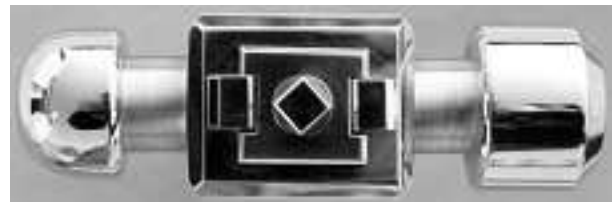
Déposant: Charles Grosbéty, Rue de l'Industrie 18,
1373 Chavornay; Franco Salzano, Rue de la Tournelle 4,
1350 OrbeDesigner: Charles Grosbéty, Chavornay
Mandataire: INFOSUISSE Information Horlogère et
Industrielle, 2302 La Chaux-de-Fonds

1

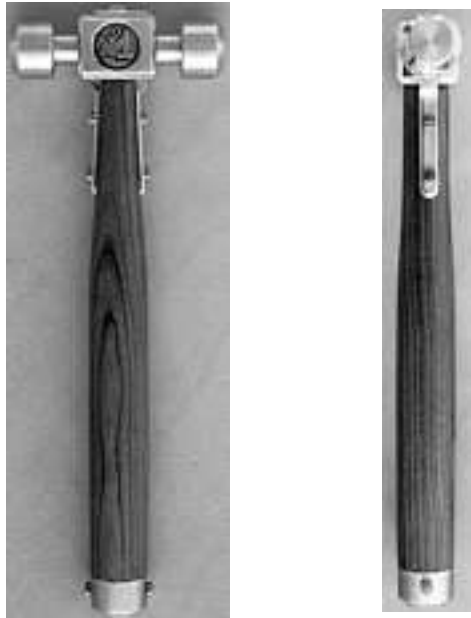

2



Cl. 12-08 133 828 28.03.2007
 1 design – automobile
 Depositante: Honda Motor Co., Ltd., No. 1-1, 2-chome,
 Minami-aoyama, Minato-ku, Tokyo, JP
 Designer: Daisuke Sawai, Saitama
 Mandatario: Fiammenghi-Fiammenghi, 6900 Lugano
 Priorità: JP, 22.12.2006

497

Cl. 12-11 133 829 22.03.2007
1 design – motorscooter
Depositante: Honda Motor Co., Ltd., No. 1-1, 2-chome,
Minami-aoyama, Minato-ku, Tokyo, JP
Designer: Yoshitaka Kubota, Saitama-ken; Maurizio
Carbonara, Roma
Mandatario: Fiammenghi-Fiammenghi, 6900 Lugano
Priorità: JP, 29.09.2006





1

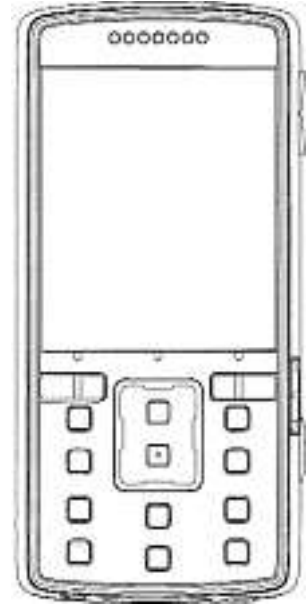
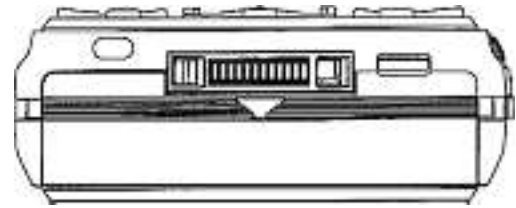
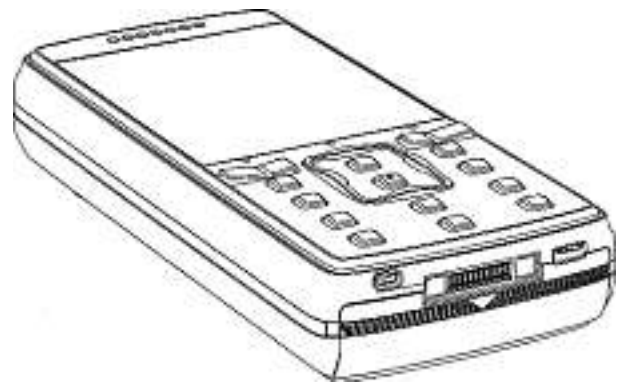

Cl. 14-03 133 830 02.04.2007
1 Design – Mobiltelefon
Hinterleger: Sony Ericsson Mobile Communications AB, Nya
Vattentornet, Lund, SE
Designer: Henrik Jensfelt, Limhamn
Vertreter: Isler & Pedrazzini AG, 8023 Zürich
Priorität: EM, 30.10.2006

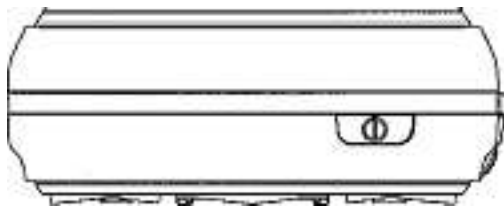

M13317

Cl. 16-05 133 832 14.03.2007
 2 Design – Kamerastativ
 Hinterleger: Ulisse Foddis, Illertalstrasse 1,
 89281 Altenstadt/Iller, DE
 Vertreter: Meyer & Kollegen, 7000 Chur
 Priorität: EM, 15.09.2006

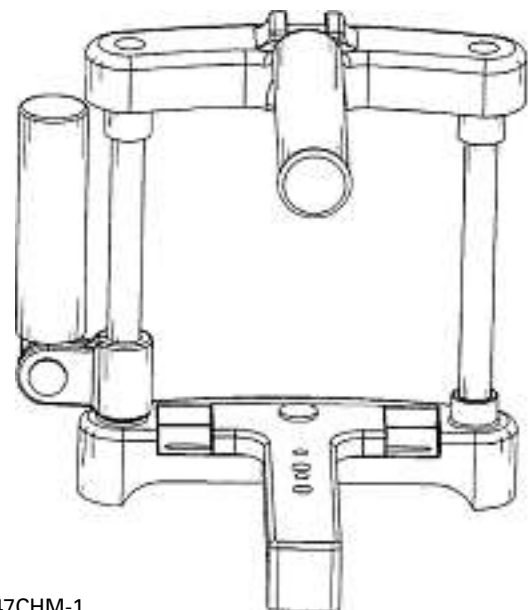
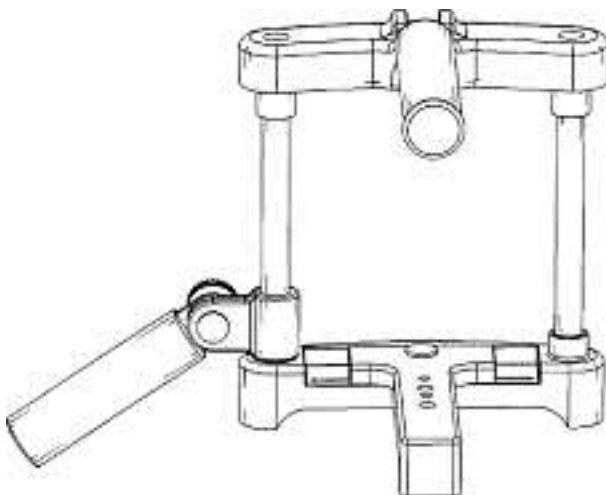
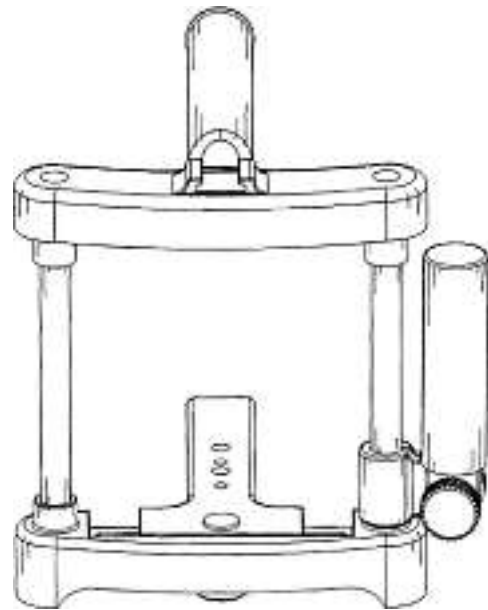
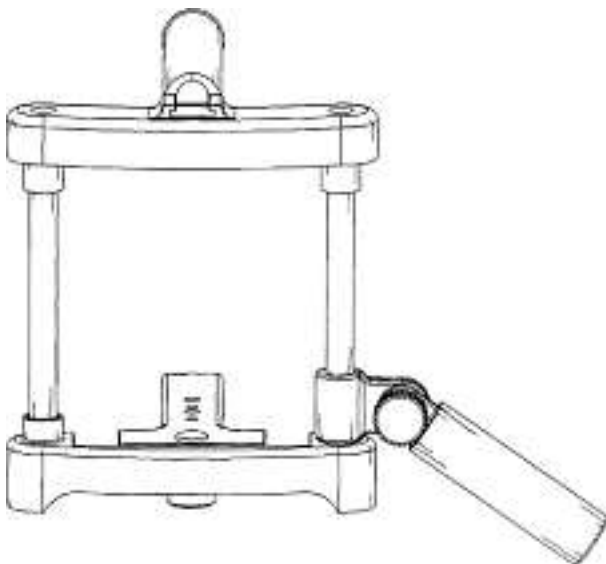
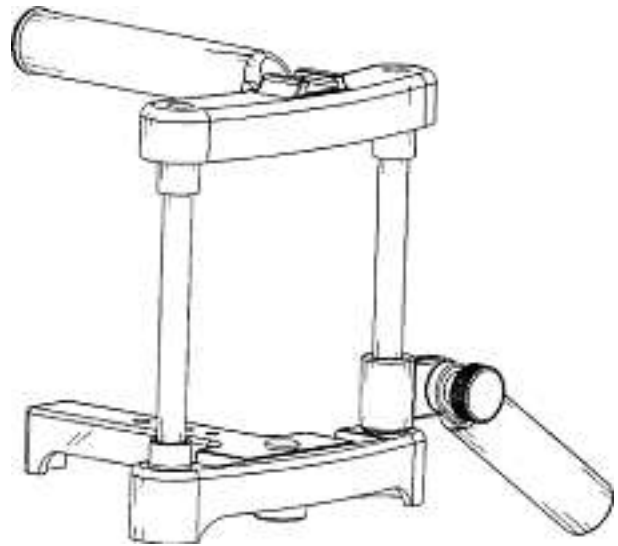

2447CHM-1

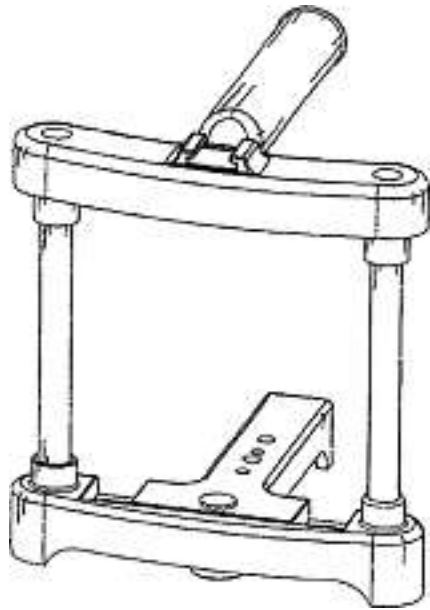

2447CHM-2

Cl. 19-02 133 833 24.03.2007

2 Design – Notizhalter

Hinterleger: Alfons Poschlod, Hardtstrasse 37a,
76185 Karlsruhe, DE

Vertreter: Heinz Sollberger, 4563 Gerlafingen

Priorität: DE, 25.10.2006

Beschreibung des Designs: Halterungsvorrichtung zur Aufnahme von Papier allgemein, Visitenkarten, Postkarten, Prospekte, Notizzettel, Fotos und andere.



Memo Dot I



Memo Dot II

Cl. 20-02 133 835 20.03.2007

2 design – carte de menus, carte des vins

Déposant: Nathalie Sylvestre-Torti, Rue des Auges 11,
1635 La Tour-de-Trême



quête-1



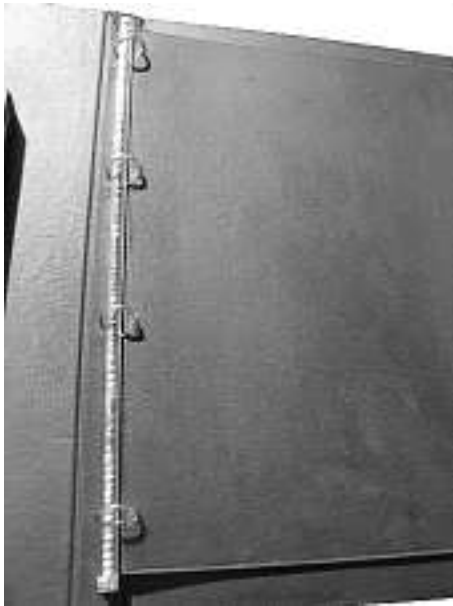

quête-2



0032-MO-0570-CH-CH-01

Cl. 20-02, 20-03 **133 836** 22.03.2007
 7 design – bustes, mannequin, colonnes
 Déposant: "Royal Swiss" Montres et Bijoux SA, rue du
 Rhône 23, 1204 Genève
 Designer: Yves Niffeler, Genève
 Mandataire: Griffes Consulting S.A., 1206 Genève



0032-MO-0571-CH-CH-01



0032-MO-0572-CH-CH-01



0032-MO-0569-CH-CH-01



0032-MO-0573-CH-CH-01



0032-MO-0574-CH-CH-01



0032-MO-0575-CH-CH-01

Cl. 20-03 **133 837** 23.03.2007
 2 Design – Kennzeichenhalter
 Hinterleger: CarSign AG, Grünaustrasse 25, 9471 Buchs
 Designer: Heinz Vogt, Schaan
 Vertreter: Riederer Hasler & Partner Patentanwälte AG,
 7310 Bad Ragaz



1



2

Cl. 21-01 **133 838** 23.03.2007
 13 Design – Spielvorlagen
 Hinterleger: Greta Simmen Eberle, Rebhaldenstrasse 1,
 8303 Bassersdorf



1



2



3



4



5



6



11



12



7



8

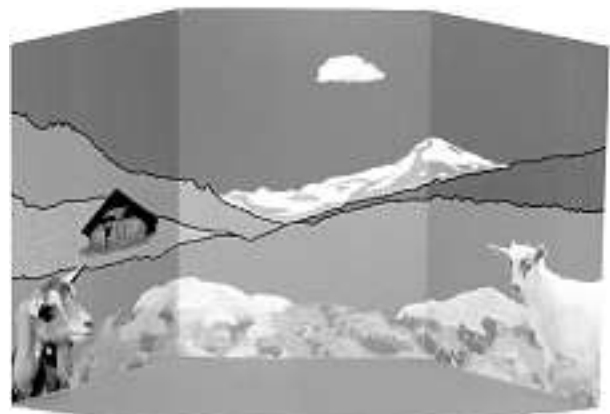

13



9



10

Cl. 23-02 **133 839** 08.03.2007
 2 Design – Waschbecken
 Hinterleger: Bombazurra Design, Béatrice R. Zurlinden
 Ryhiner, Bruderholzallee 220, 4059 Basel
 Designer: Béatrice R. Zurlinden Ryhiner, Basel





BOL 1 Tischmodell



BOL 2 Wandmodell

Cl. 23-02 **133 840** 12.03.2007
3 Design – Abläufe, Überläufe
Hinterleger: Niro-Plan AG, Franke-Strasse 2, 4663 Aarburg
Designer: Christian Bomatter, Melisey
Vertreter: R. A. Egli & Co., Patentanwälte, 8008 Zürich
Priorität: DE, 14.09.2006

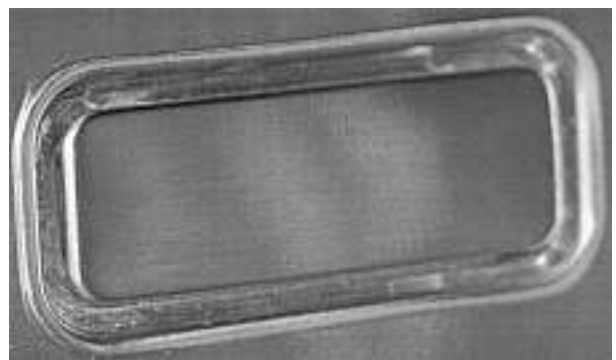

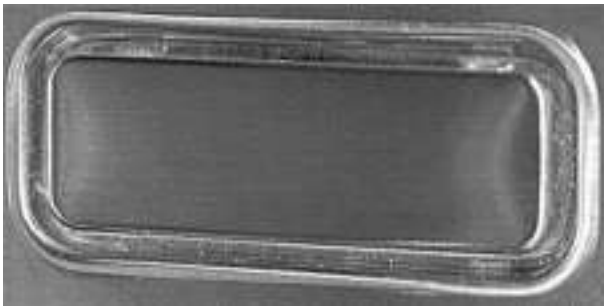
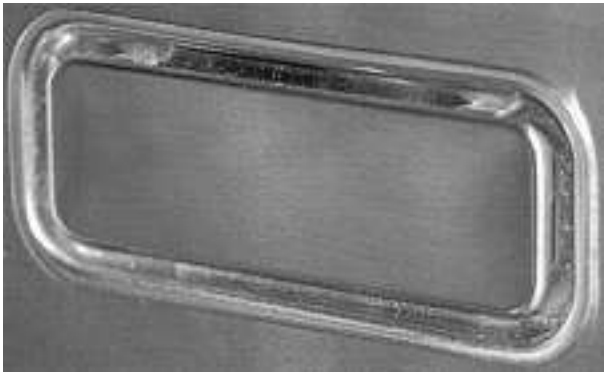

1

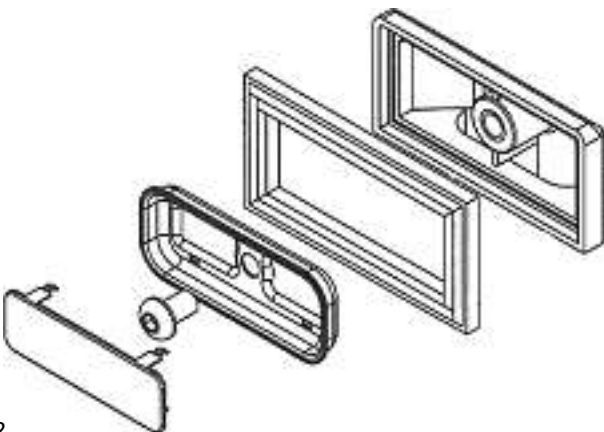
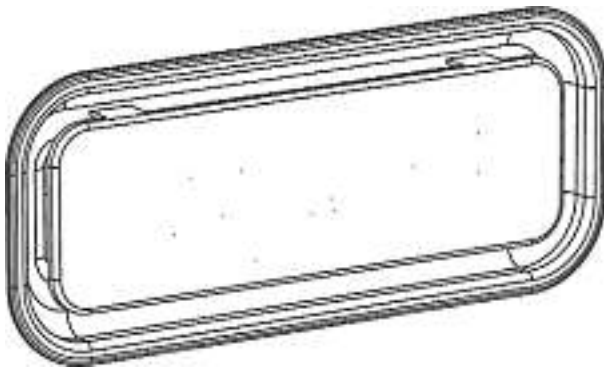

2

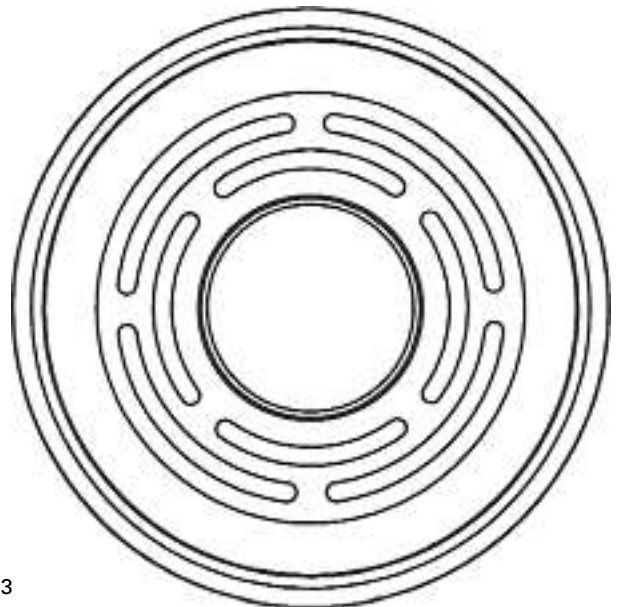
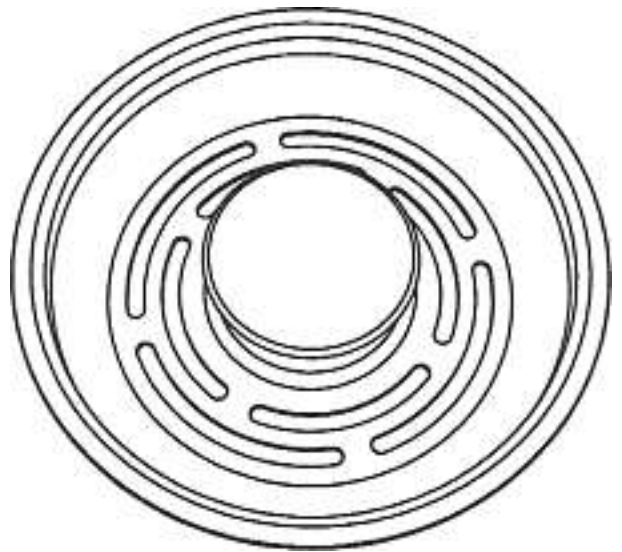
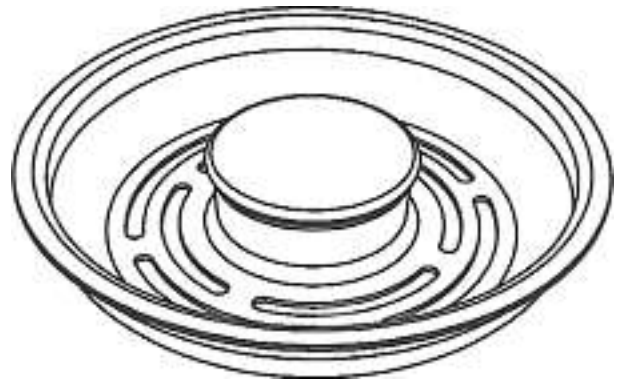

3

Cl. 24-02 **133 841** 27.03.2007
 1 Design – Untersuchungsgerät
 Hinterleger: Inverness Medical Switzerland GmbH,
 Bundesplatz 1, 6300 Zug
 Designer: Paul Laverack, Milton Keynes
 Vertreter: E. Blum & Co. AG, Patent- und Markenanwälte
 VSP, 8044 Zürich
 Priorität: GB, 27.09.2006

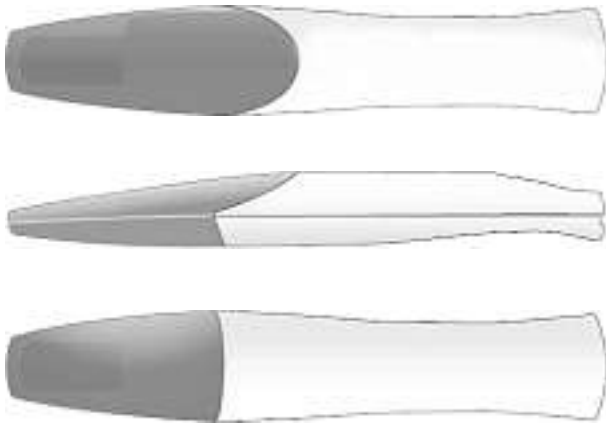

1

Cl. 24-04 133 842 12.03.2007
18 Design – Schuheinlagen
Hinterleger: Lothar Jahrling, Steinweg 58, 35440 Linden, DE
Vertreter: Patentanwälte Schaad, Balass, Menzl &
Partner AG, 8034 Zürich
Priorität: EM, 18.09.2006

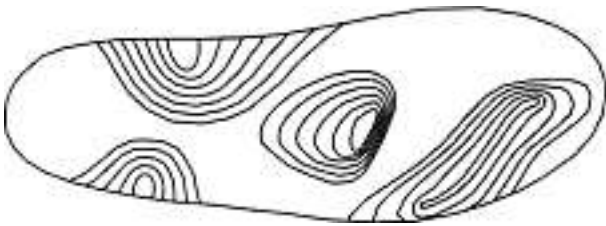

1



2

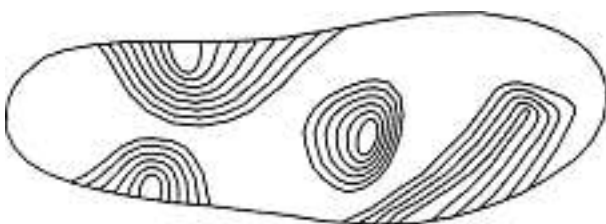

3



4

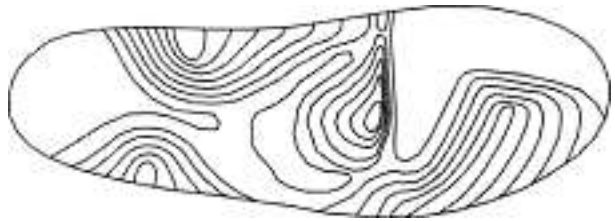

5



6

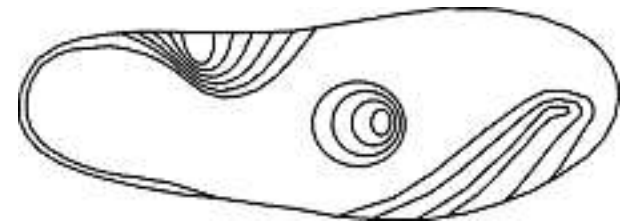

7



8

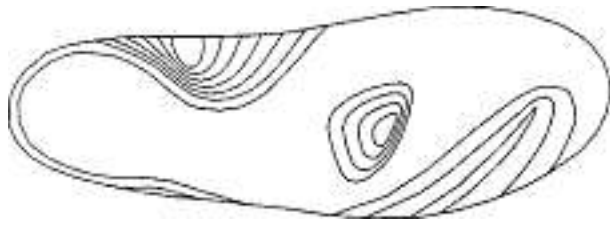

9



10

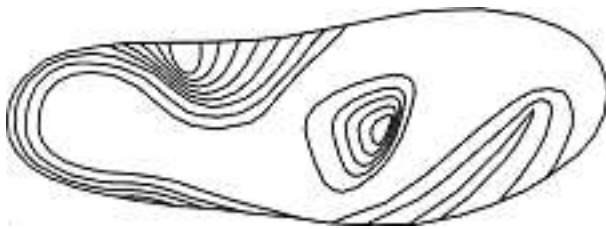

11



12

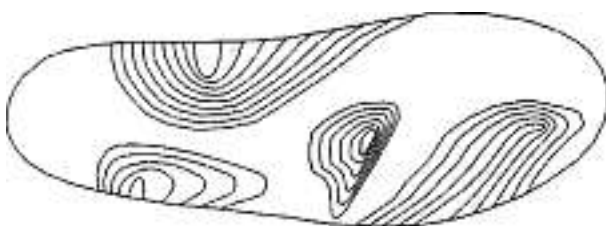

13



14

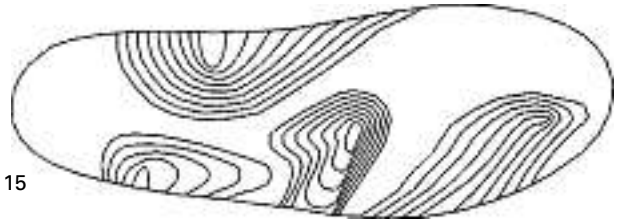

15



16

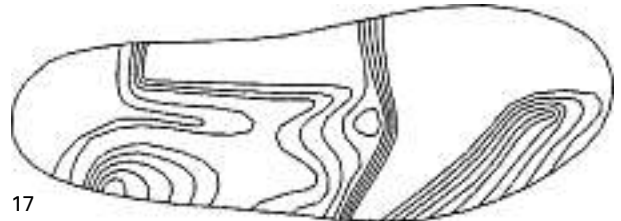

17

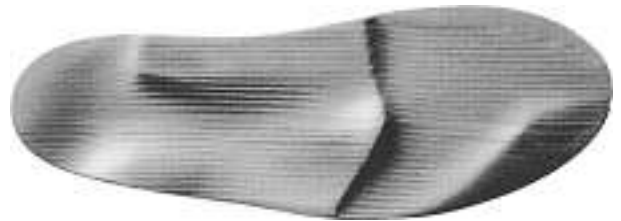

18

Cl. 26-05 133 843 12.03.2007
1 Design – Leuchte
Hinterleger: Urs Gramelsbacher, Leonhardsgraben 61, 4051
Basel

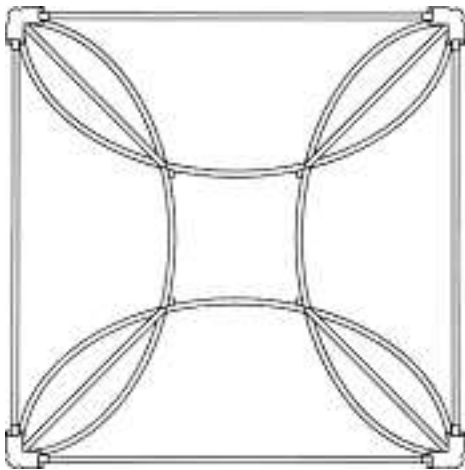
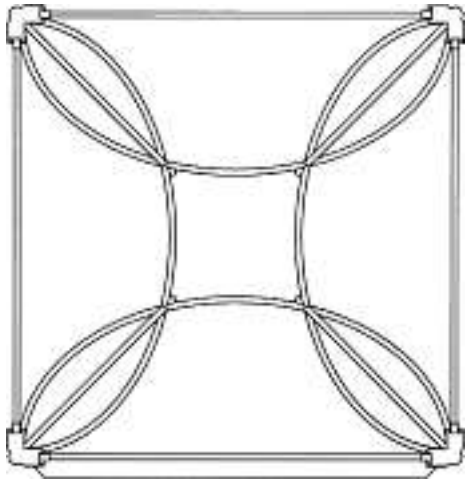

12



M3

Cl. 26-05 133 844 04.04.2007
1 Design – Leuchte
Hinterleger: Martin Iseli, Vereinsweg 18, 3012 Bern



**Verlängerungen
Prolongations
Prolongazioni**

119 512 Cl. 09-03 1 Design



1



119 625 Cl. 25-02 3 Design



SSW A1/A2 mit SEA 41

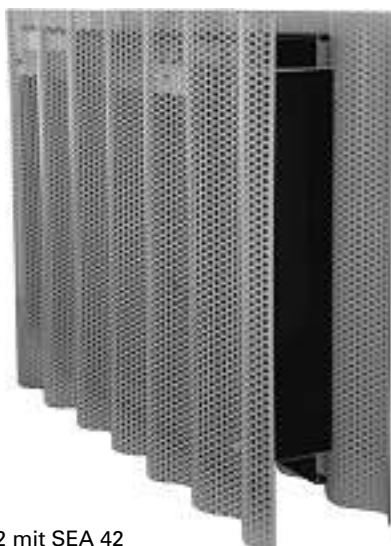

SSW A1/A2 mit SEA 42



SSW A1/A2 mit SEA 45

119 718 Cl. 21-02 2 Design

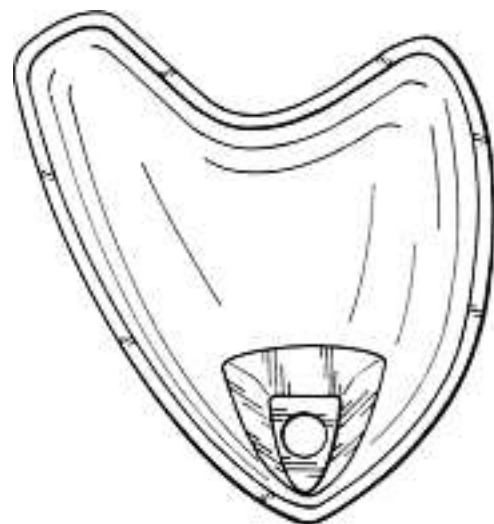
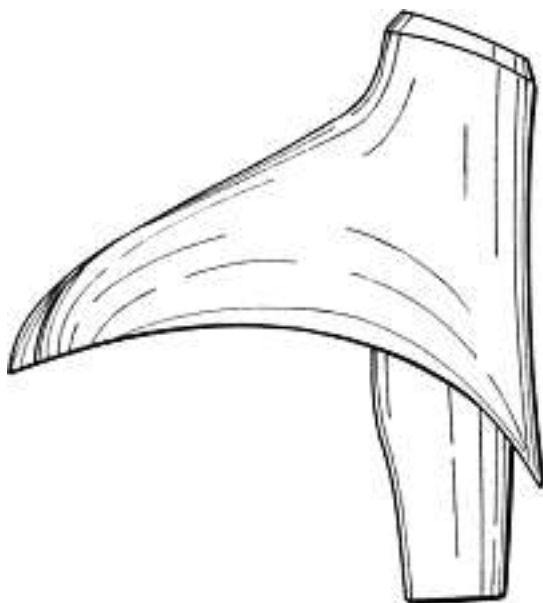
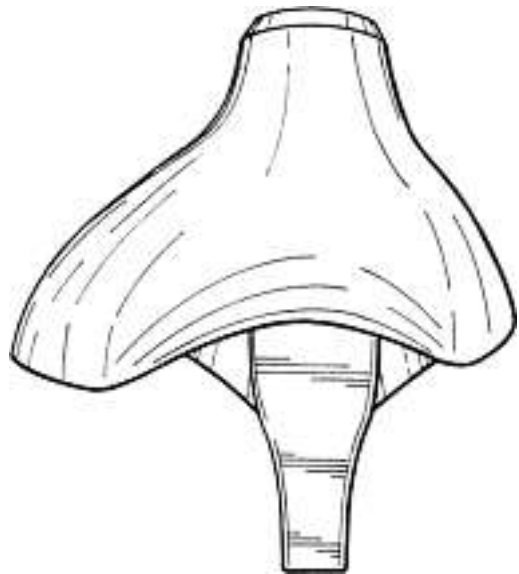
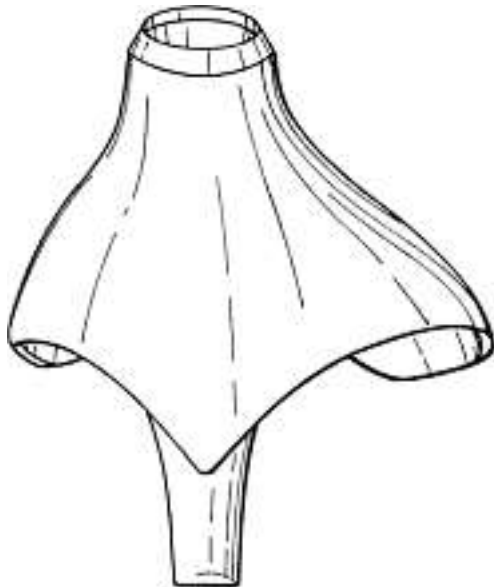
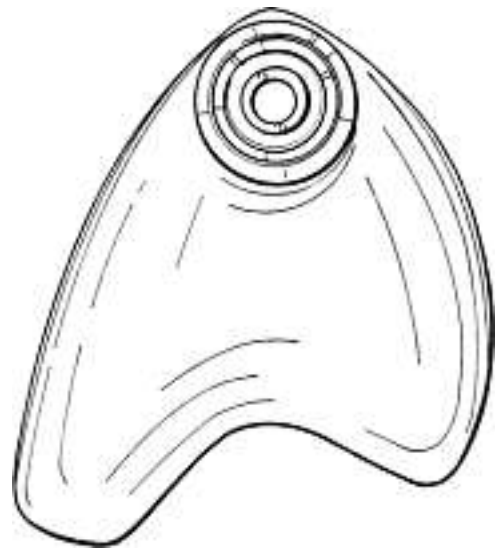
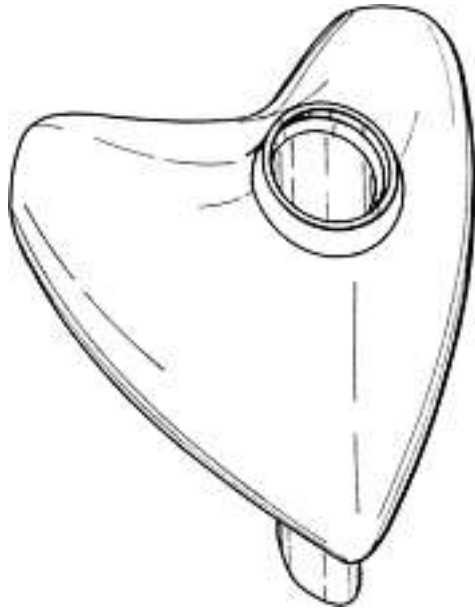

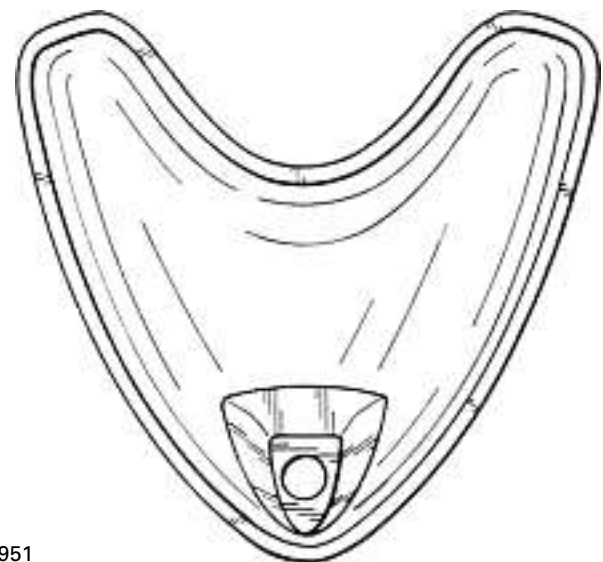
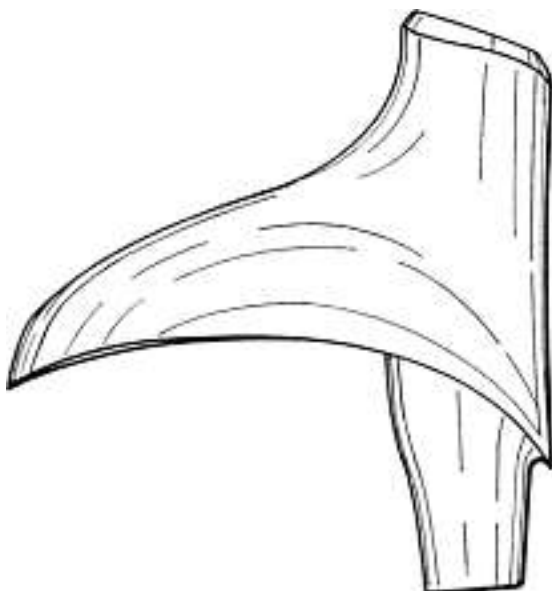
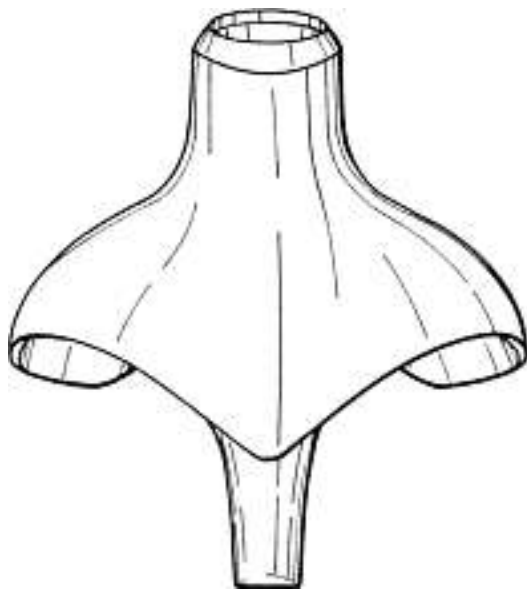
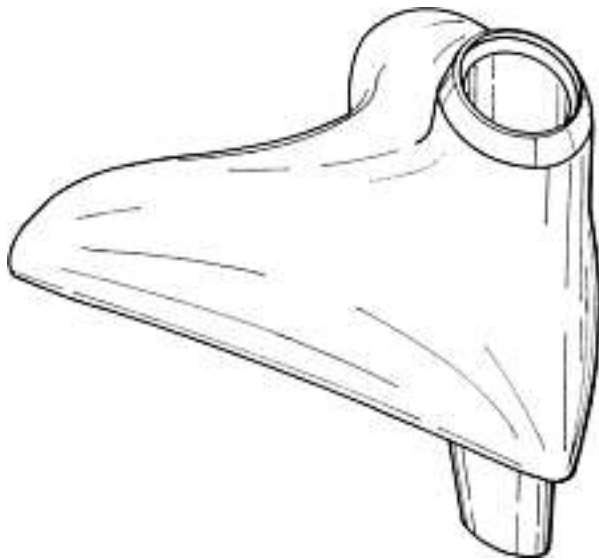

951

119 755 Cl. 04-02 2 Design



1



2

119 830 Cl. 07-06 1 Design



1

123 668 Cl. 09-03 1 design
 124 131 Cl. 07-99 1 design
 124 137 Cl. 10-07 1 design
 124 139 Cl. 12-16 1 design
 124 156 Cl. 25-02 1 Design
 124 167 Cl. 07-02 1 Design
 124 191 Cl. 25-01 4 Design
 124 297 Cl. 12-16 1 design
 124 305 Cl. 20-02 2 Design
 124 309 Cl. 25-03 1 design
 124 321 Cl. 04-02 2 Design
 124 327 Cl. 06-05 1 design
 124 364 Cl. 02-03 1 Design
 124 475 Cl. 24-02 1 Design
 128 740 Cl. 26-05 1 Design
 128 756 Cl. 08-06 2 Design
 128 757 Cl. 08-07 1 Design
 128 810 Cl. 30-07 1 design
 128 869 Cl. 08-01 1 Design
 128 959 Cl. 24-02 1 design
 128 963 Cl. 26-05 1 Design
 128 971 Cl. 06-11 1 Design
 128 991 Cl. 30-99 1 Design

129 002 Cl. 10-07 2 design
 129 027 Cl. 06-06 3 Design
 129 036 Cl. 19-06 1 Design
 129 313 Cl. 07-02 1 Design

**Mutationen
Modifications
Modificazioni**

119 786

120 233

121 792

123 642

Vertreter Firmaänderung

Vertreter: Braunpat Braun Eder AG, 4054 Basel

120 325

129 368

129 556

129 692

129 797

129 881

130 092

130 670

130 782

130 873

130 874

132 118

Nouveau mandataire

Mandataire: reuteler & cie SA, 1260 Nyon

120 467

Übertragung

Hinterleger: Clearsnap Holding, Inc., 509 30th Street,
Anacortes, Washington 98221, US

Vertreter: Kirker & Cie S.A., Ingénieurs-Conseils,

1226 Genève - Thônex

121 394

Namensänderung

Hinterleger: MTG Divestitures Inc., 235 East 42nd Street,
New York/NY 10017, US

124 327

Nuovo mandatario

Mandatario: Andrew Maconie, 1936 Verbier

129 556

129 692

130 092

130 670

132 118

Changement du nom

Déposant: PEPUP S.A., Quai des Forces-Motrices 14,
1204 Genève
**Löschungen
Radiations
Radiazioni**

119 226	Cl.	10-02	2	Design
119 228	Cl.	14-03	1	design
119 243	Cl.	10-07	1	design
119 247	Cl.	14-02	1	Design
119 249	Cl.	19-06	1	Design
119 317	Cl.	09-01	1	Design
119 341	Cl.	21-01	96	design
123 653	Cl.	06-01	3	Design
123 656	Cl.	06-03	1	Design
123 671	Cl.	09-09	1	Design
123 677	Cl.	12-15	1	design
123 732	Cl.	06-09	1	Design
123 738	Cl.	08-05	2	Design
123 816	Cl.	24-02	1	Design
128 270	Cl.	02-05	1	Design
128 271	Cl.	03-01	9	Design
128 272	Cl.	06-01	1	Design
128 273	Cl.	06-01	1	Design
128 278	Cl.	07-01	1	Design
128 279	Cl.	07-01	2	Design
128 290	Cl.	13-03	7	Design
128 307	Cl.	05-06	4	Design
128 308	Cl.	06-01	18	Design
128 309	Cl.	06-01	1	Design
128 310	Cl.	06-03	4	Design
128 311	Cl.	06-04	15	Design
128 325	Cl.	11-02	2	Design
128 328	Cl.	15-06	1	Design
128 329	Cl.	20-02	11	design
128 332	Cl.	25-03	1	Design
128 333	Cl.	26-05	1	Design
128 334	Cl.	27-06	1	Design
128 361	Cl.	13-03	3	Design
128 379	Cl.	04-02	1	Design
128 392	Cl.	10-05	2	Design
128 436	Cl.	09-01	1	design